

APPENDIX 1

VENUE EQUIPMENT-1 MATCH PLAY CHARTS

1 A. MATCHPLAY CHARTS 104 athletes, byes will be permitted (the 8 top athletes have byes)

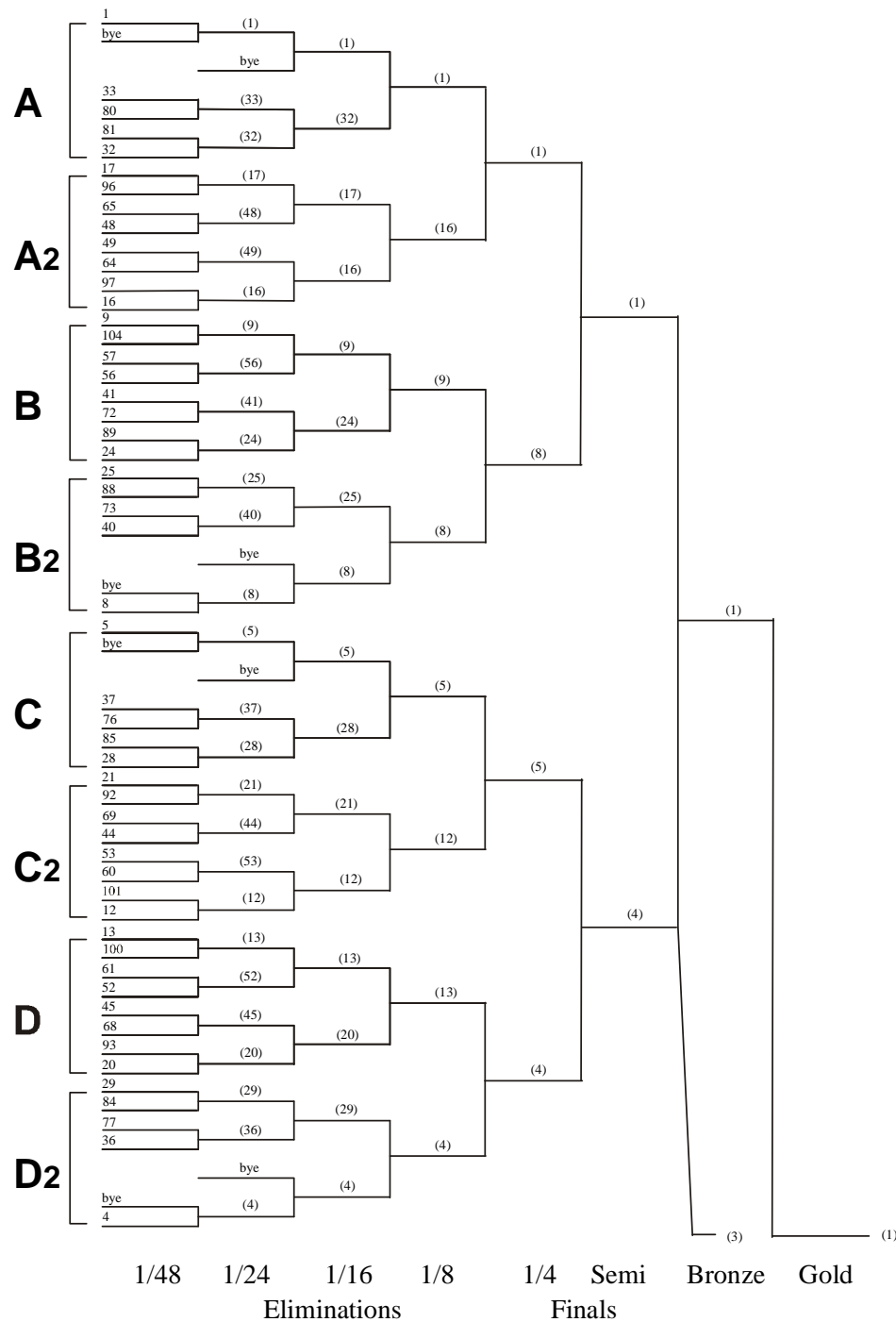

BOOK 2

FITA CONSTITUTION AND RULES

1 B. MATCH PLAY CHART 104 athletes, byes will be permitted (the 8 top athletes have byes)

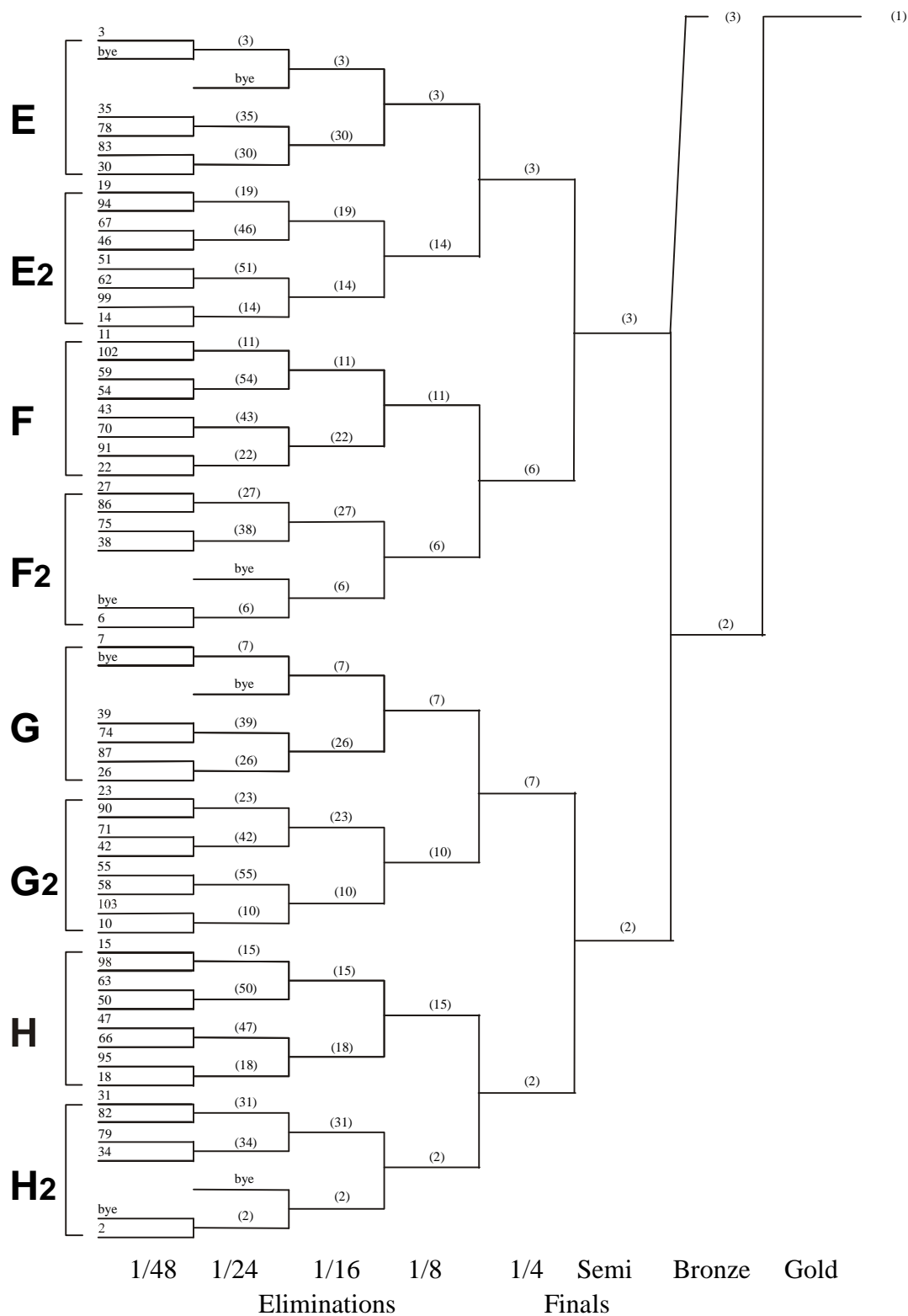

2. MATCH PLAY CHART (64 athletes, byes will be permitted)

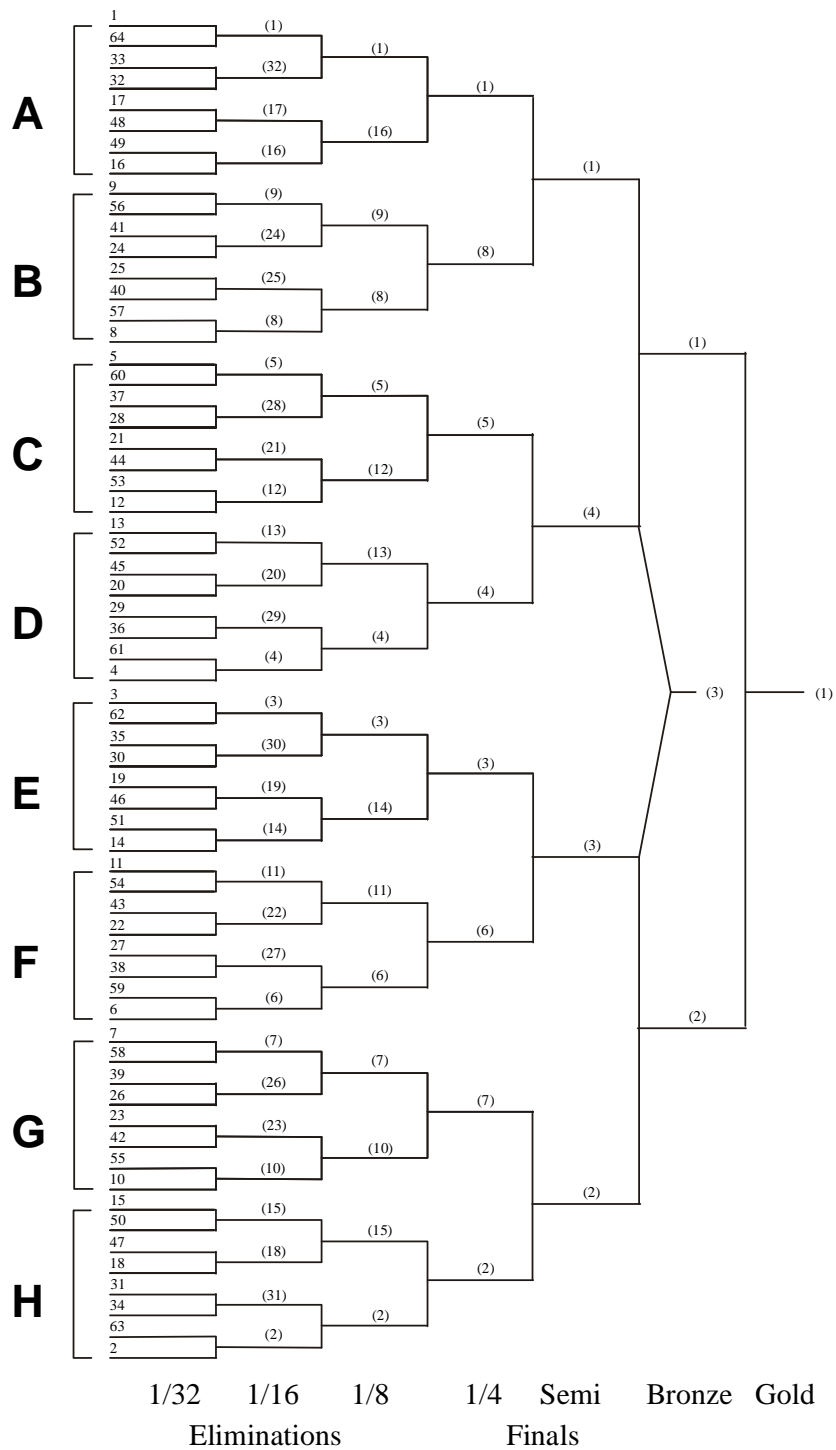

Order of shooting: all all all CD/EF EFGH
 GH/AB ABCD

3. MATCH PLAY CHART (32 athletes, byes will be permitted)

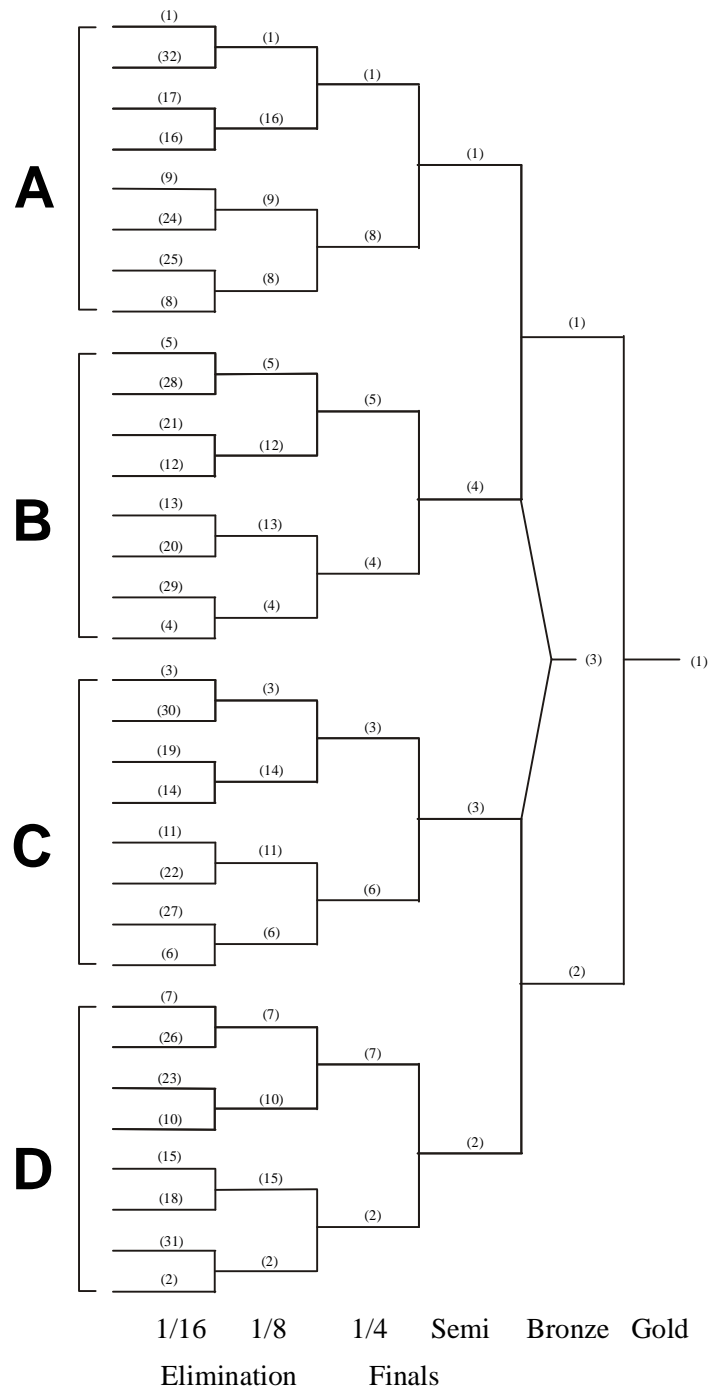

4. MATCH PLAY CHART (16 athletes or 16 teams, byes will be permitted)

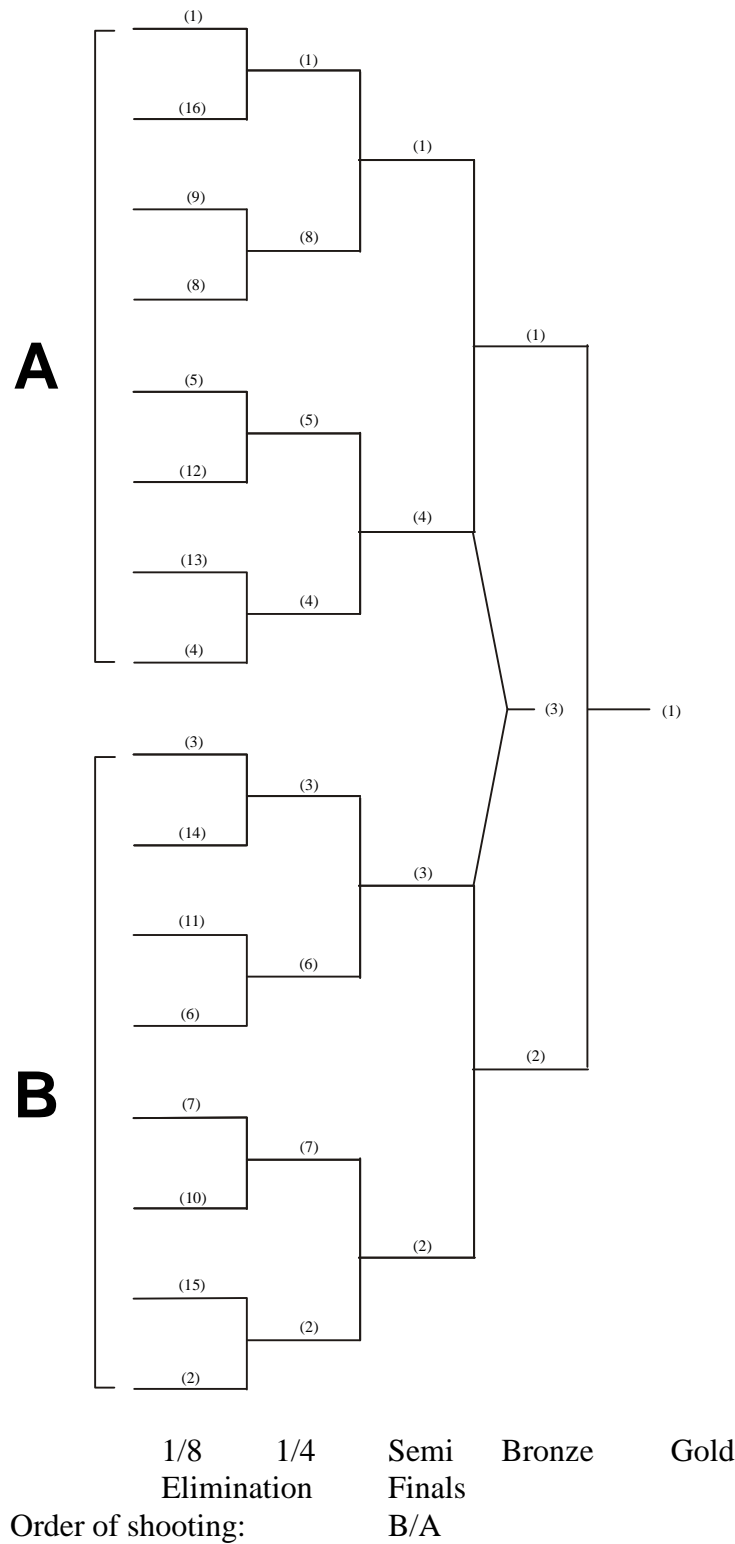

VENUE EQUIPMENT-3 Target-Faces

1. OUTDOOR BUTT SET-UP

article 7.1.1.3 and 7.1.1.4 and article 7.2.3

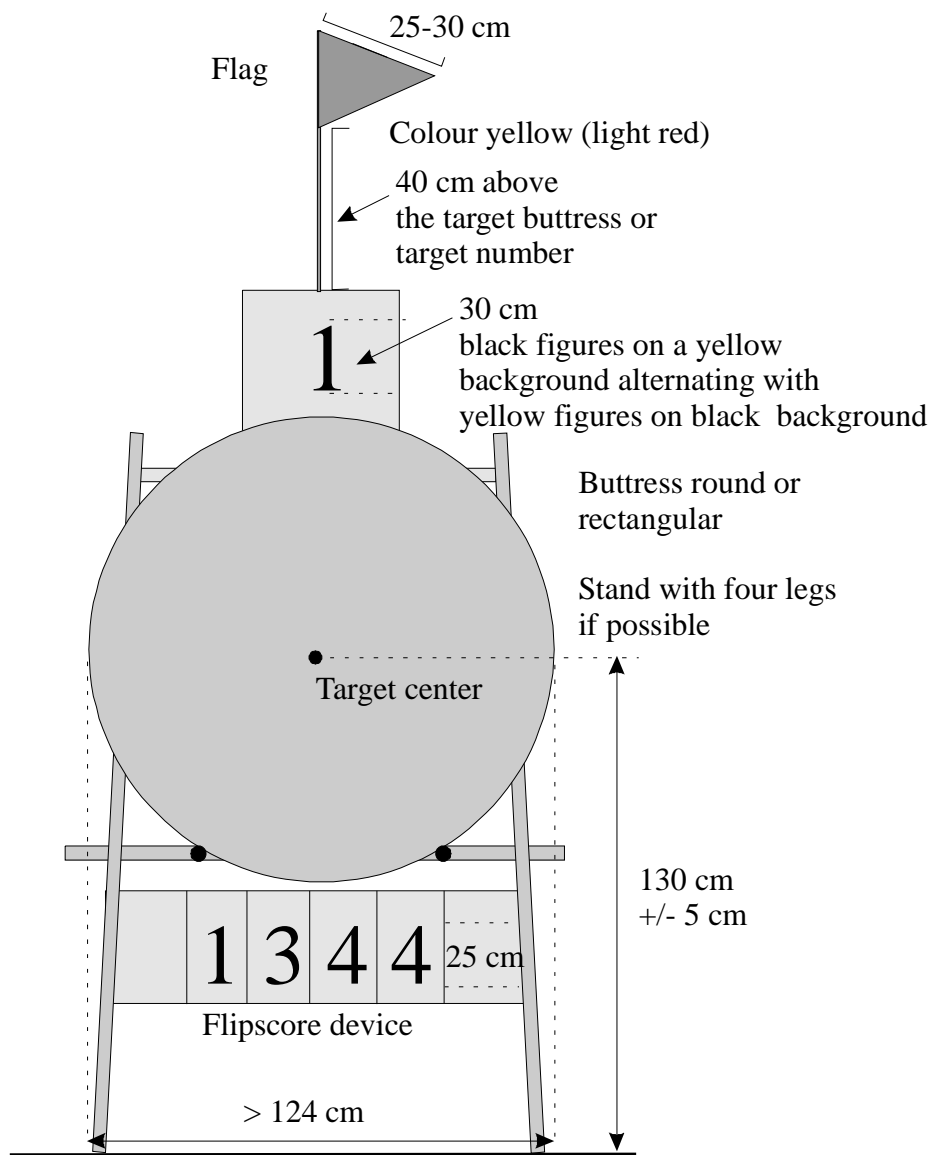

BOOK 2

FITA CONSTITUTION AND RULES

2. OUTDOOR TARGET FACE

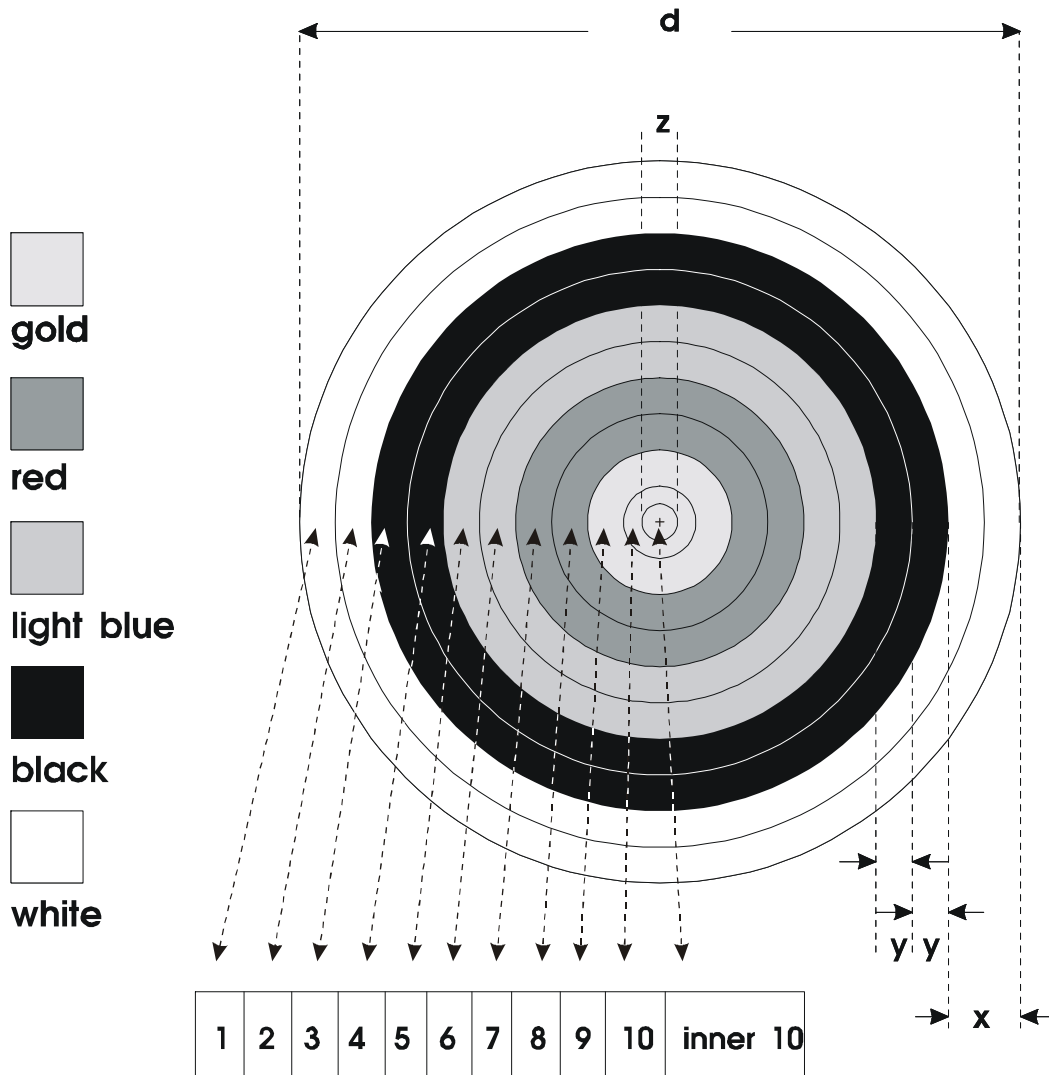

d	x	y	z
diameter of face	color zone	scoring zone	diameter of inner 10
122 cm	12.2 cm	6.1 cm	6.1 cm
80 cm	8 cm	4 cm	4 cm

3. OUTDOOR - 80CM-CENTER MULTIPLE FACE SET-UP
 articles 7.2.1 and 7.2.2

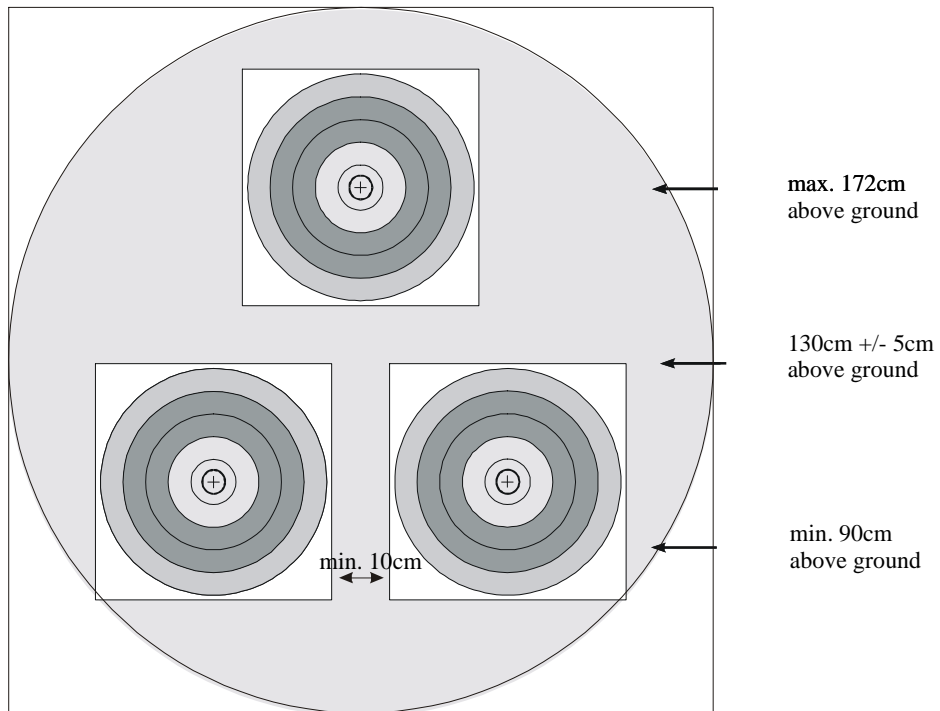

3 x 80cm 5-ring faces with scoring zones 6-10

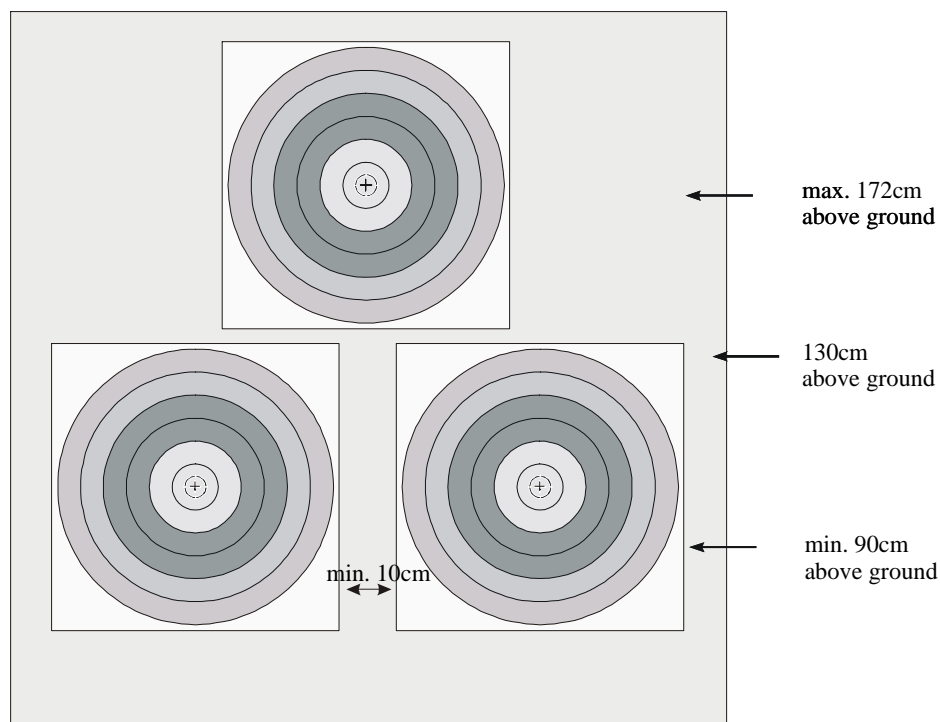

3 x 80 cm 6-ring faces with the scoring zones 5-10

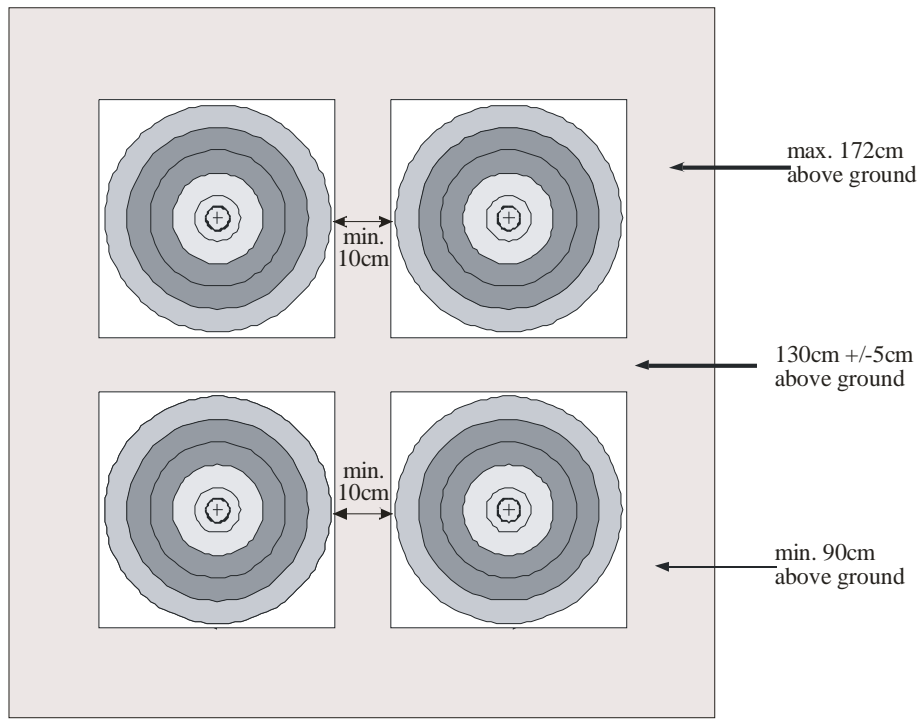

4 x 80cm 5-ring faces with the scoringzones 6-10

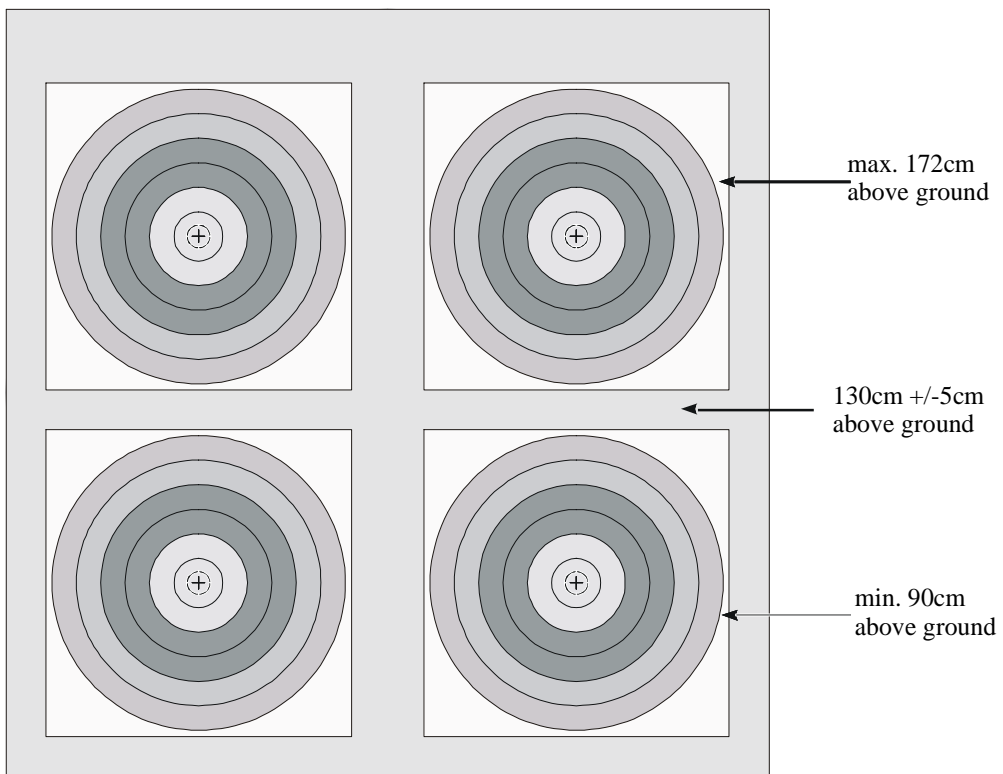

4 x 80cm 6-ring faces with the scoringzones 5-10

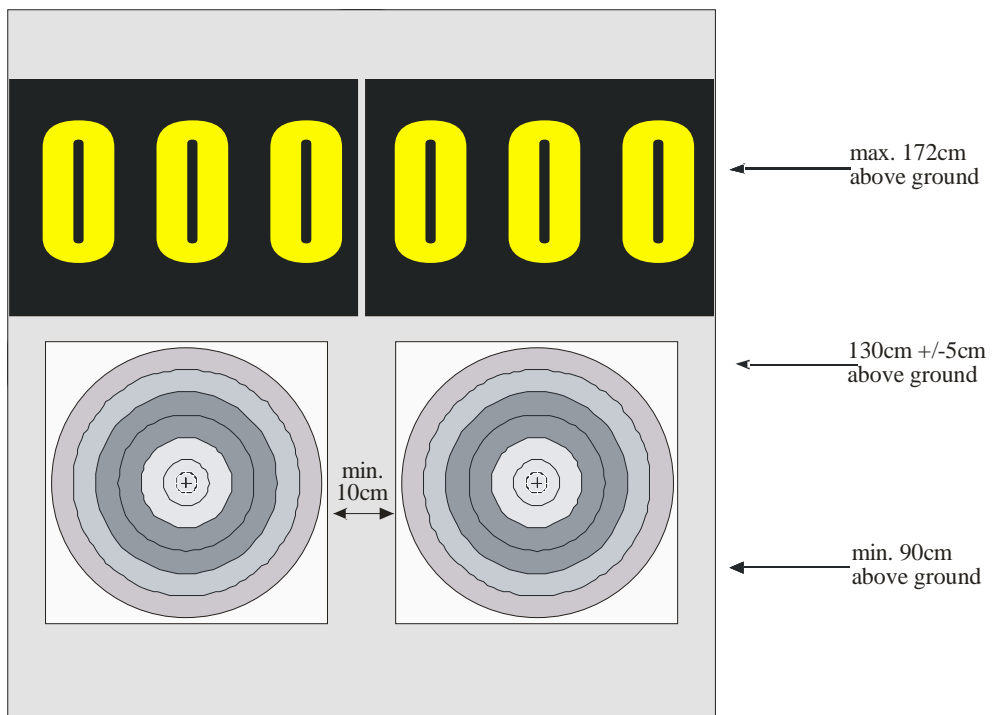

2 x 80cm 6-ring faces with the scoring zones 5-10

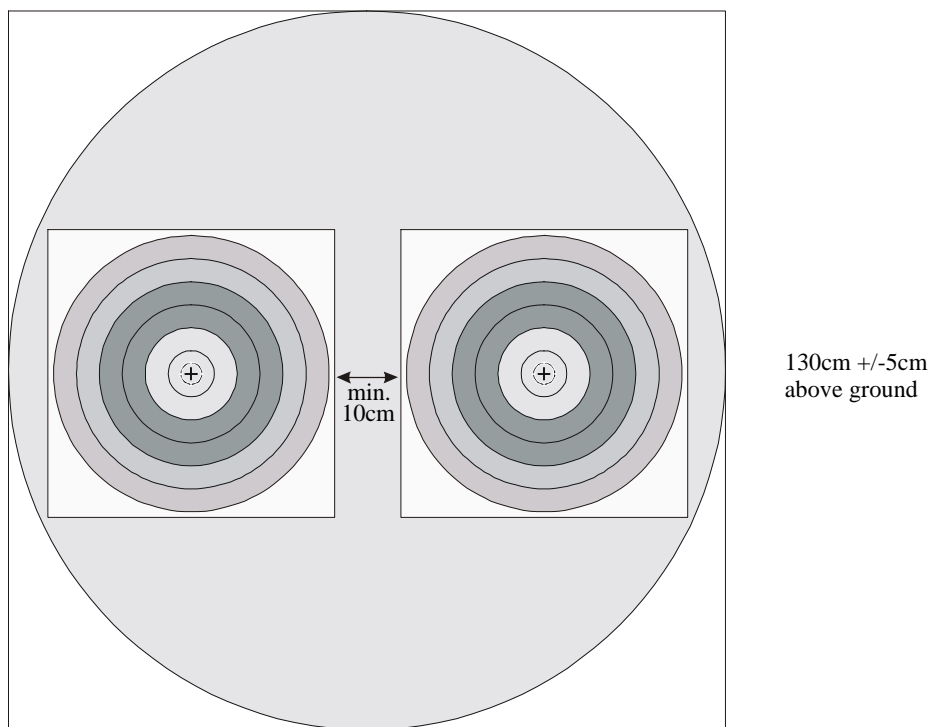

2 x 80cm 6-ring faces with the scoring zones 5-10

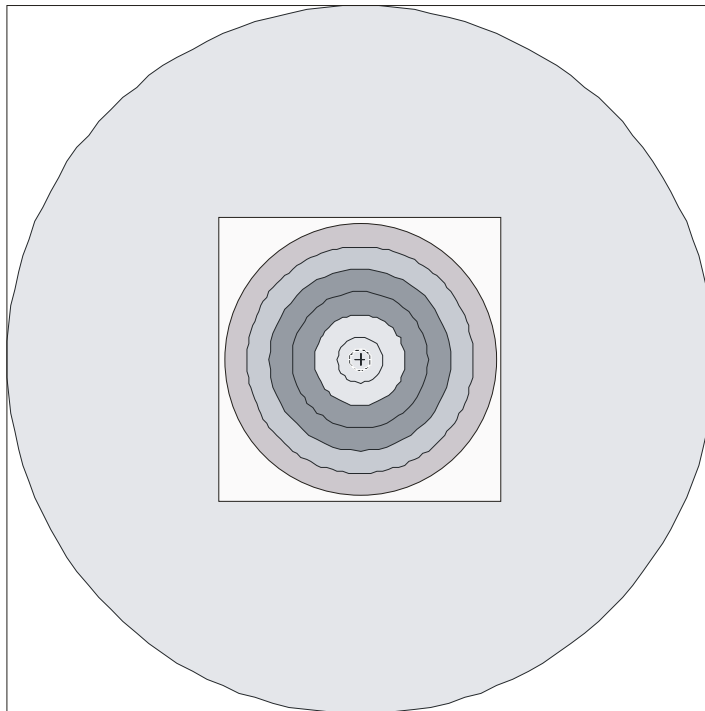

130cm +/-5cm
above ground

1 x 80cm 6-ring face with the scoring zones 5-10