



ELSEVIER

Available online at www.sciencedirect.com



Human Movement Science 22 (2003) 37–45

HUMAN
MOVEMENT
SCIENCE

www.elsevier.com/locate/humov

Activation patterns in forearm muscles during archery shooting

H. Ertan ^{a,*}, B. Kentel ^b, S.T. Tümer ^b, F. Korkusuz ^a

^a Department of Physical Education and Sports, Middle East Technical University, Ankara 06531, Turkey

^b Department of Mechanical Engineering, Middle East Technical University, Ankara 06531, Turkey

Abstract

A contraction and relaxation strategy with regard to forearm muscles during the release of the bowstring has often been observed during archery, but has not well been described. The purpose of this study was to analyze this strategy in archers with different levels of expertise; elite, beginner and non-archers. Electromyography (EMG) activity of the M. flexor digitorum superficialis and the M. extensor digitorum were recorded at a sampling frequency of 500 Hz, together with a pulse synchronized with the clicker snap, for twelve shots by each subject. Raw EMG records, 1-s before and after the clicker pulse, were rectified, integrated and normalized. The data was then averaged for successive shots of each subject and later for each group. All subjects including non-archers developed an active contraction of the M. extensor digitorum and a gradual relaxation of the M. flexor digitorum superficialis with the fall of the clicker. In elite archers release started about 100 ms after the fall of the clicker, whereas in beginners and non-archers release started after about 200 and 300 ms, respectively. Non-archers displayed a preparation phase involving extensive extensor activity before the release of the bowstring, which was not observed in elite and beginner archers. In conclusion, archers released the bowstring by active contraction of the forearm extensors, whereas a clear relaxation of the forearm flexors affecting the release movement was not observed.

© 2003 Elsevier Science B.V. All rights reserved.

PsycINFO classification: 3720

Keywords: Archery; Electromyography (EMG); Muscular analysis

* Corresponding author. Tel.: +90-3122104025; fax: +90-3122101255.

E-mail addresses: hertan@metu.edu.tr, hayriertan@yahoo.com (H. Ertan).

1. Introduction

Archery can be described as a comparatively static sport requiring strength and endurance of the upper body, in particular the forearm and shoulder girdle (Mann & Littke, 1989). Skill in archery is defined as the ability to shoot an arrow to a given target in a certain time span with accuracy (Leroyer, Hoecke, & Helal, 1993). The discipline is described as a three-phase (the stance, the drawing and the sighting) movement. Nishizono, Shibayama, Izuta, and Saito (1987) further divided these phases into six: bow hold, drawing, full draw, aiming, release and follow-through. Each of these phases represented a stable sequence of movements and was ideal for studying the motor control and skill acquired during this voluntary kinematic process.

An archer pushes the bow with an extended arm, which is statically held in the direction of the target, while the other arm exerts a dynamic pulling of the bowstring from the beginning of the drawing phase, until the release is dynamically executed (Leroyer et al., 1993). The release phase must be well balanced and highly reproducible to achieve commendable results in a competition (Nishizono et al., 1987).

The bowstring is released when an audible impulse is received from a device called “clicker” that is used as a draw length check (Leroyer et al., 1993). Each arrow can be drawn to an exact distance and a standard release can be obtained using this device (Fig. 1). The clicker is reputed to improve the archer’s score and used by all target archers. The archer should react to the clicker as quickly as possible. In particular, a repeated contraction and relaxation strategy in the forearm and pull finger muscles should be developed for this reason.

The contraction and relaxation strategy in forearm muscle during the release of the bowstring is critical for accurate and reproducible scoring in archery. Two different approaches to this strategy were proposed in previous studies; however, they were not well defined (Clarys et al., 1990; Hennessy & Parker, 1990; Martin, Siler, & Hoffman, 1990; McKinney & McKinney, 1997; Nishizono et al., 1987). The first approach suggested that an archer should release the bowstring through a sudden

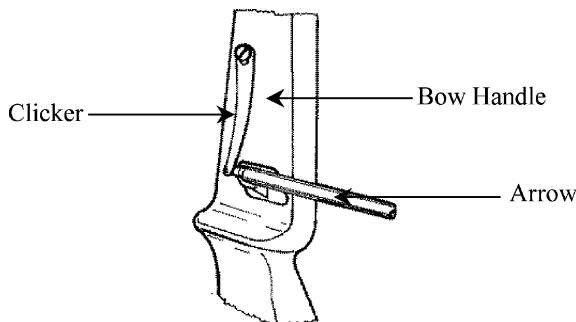

Fig. 1. Clicker; a spring-loaded lever that produces an audible impetus to the archer that the arrow has been drawn to a fixed distance.

relaxation of the muscles that maintain the flexed position of the fingers around the bowstring rather than attempting to affect the release moment by willingly extending the fingers through concentric antagonistic muscle action (Martin et al., 1990). In other words, it is suggested that the archer relaxes the flexors, as the force of the string on the fingers is sufficient to produce extension. An active extension of the pull fingers is proposed to produce lateral deflections of the bowstring and to be less consistent with the shot-to-shot performance (McKinney & McKinney, 1997). The second approach suggested the relaxation of the flexors and contraction of the extensors. Muscular coordination between the agonist and antagonist muscles of the forearm is essential in this strategy and requires a relatively long training period (Clarys et al., 1990; Hennessy & Parker, 1990; Nishizono et al., 1987).

Previous studies were not able to clarify the contraction and relaxation strategy of the forearm muscles that was used by archers. All studies were confined to a limited number of elite archers and both strategies were sometimes observed in the same group. Studies did not only involve the forearm muscles that are crucial for accurate and reproducible scoring, but the activity of all upper extremity muscles was measured. Furthermore, the effect of performance level on this strategy was not investigated. It is hypothesized that archers develop a specific forearm and pull finger muscle activation strategy by active contraction of the forearm extensors with the fall of the clicker. Furthermore, the reaction time is expected to be shorter as the level of performance of the archer increases.

Thus, the aims of this study were: (i) to analyze the activation strategy of forearm muscles during archery shooting, and (ii) to investigate the effect of performance on this strategy in elite, beginner and non-archers.

2. Methods

Three groups, (i) elite ($n = 10$), (ii) beginners ($n = 10$) and (iii) non-archers ($n = 10$), were involved in the study. All groups contained 5 male and 5 female subjects. The first group consisted of national team archers. The second group was formed by beginner archers from the city archery club. The third group included university students with no background knowledge or experience on archery. Information on the participants including the Federation Internationale de Tir à l'Arc (FITA, 1996) scores, years of archery experience, and ages is presented in Table 1.

Table 1
Means and standard deviations of FITA scores, years of archery experience, and ages of the subjects

	Elite archers		Beginner archers		Non-archers	
	Male	Female	Male	Female	Male	Female
Number	5	5	5	5	5	5
Age	21.8 ± 3.4	24.8 ± 2.5	17.3 ± 2.5	16.6 ± 3.2	28.2 ± 4.2	24.4 ± 3.7
FITA scores	1296 ± 43	1322 ± 24	1157 ± 35	1147 ± 40	–	–
Years of training	8 ± 0.7	10 ± 1.1	5 ± 0.6	4 ± 0.4	–	–

Each subject participated in a single test session. Electromyography (EMG) of the *M. flexor digitorum superficialis* and the *M. extensor digitorum* were quantified. The surface electrodes were placed on the central portion of each muscle. Recording sites on the drawing arm were identified by palpating the selected muscles during the time subjects simulated the preparatory shooting position and performed maximum isometric contraction. These sites were prepared first by shaving the area and then lightly abrading and cleansing the skin with alcohol. Skin tack F55 electrodes, filled with conductive electrolyte, were then positioned on the surface of each muscle. The distance between two electrodes was approximately 2 cm. The reference electrode was placed on the olecranon process of the ulna of the drawing arm.

A mechanical switch was attached to the bow handle to accurately measure the moment of the fall of the clicker (Fig. 2). The signal obtained from the fall of the clicker was superimposed on the EMG recordings. Forearm muscular activation strategies were evaluated from the EMG recordings immediately before and after the fall of the clicker. The arrow was initially positioned between the unattached end of the clicker and the bow-grip. As the arrow was pulled beyond the clicker, the lever fell on the bow handle, and conveyed the signal to the archer. The arrow was released with this fall.

Measurements were made under laboratory conditions. Each subject completed three trial shots to get acquainted with the measurement conditions. Muscle activity was sampled during a 5-s period as the subjects completed 12 successive shots. For the shooting trials, the sampling was manually triggered shortly after the archer achieved a full draw so that the release of the arrow occurred at approximately the midpoint of the sampling period.

Subjects completed twelve successive shots at the experimental part of the study. EMG recordings were for 5, 2.5 s prior and 2.5 s after the fall of the clicker. This time period included the last seconds of full draw, aiming and the first milliseconds of release and follow-through phases. Two-second periods –1 s before and 1 s after the fall of the clicker – were used to obtain the rectified EMG data. The data were then averaged across 100 ms intervals according to Martin et al. (1990) and the amplitudes were normalized according to Clarys et al. (1990). Prior to the shootings the maximum voluntary contraction (MVC) of the *M. extensor digitorum* and *M. flexor*

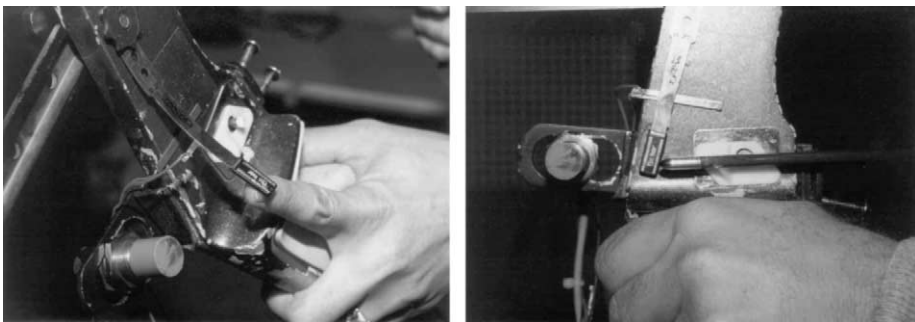

Fig. 2. Placement of the switch to synchronize clicker's fall with EMG measurements.

digitorum superficialis of each subject were determined on the basis of EMGs. Subjects contracted these muscles to the highest level against a stable resistance by forming three-finger hook as they did in holding the bowstring and MVC was obtained under these circumstances. EMG amplitudes were normalized with respect to MVC, i.e. they were expressed as percentages of MVC.

Descriptive statistics were applied to identify the characteristics of the subjects and groups. Mean scores were calculated for each subject's 12 shots and averaged across each group. Paired samples *t*-tests were used for within-group analyses and to assess significant differences between scores of M. extensor digitorum and M. flexor digitorum superficialis during each time interval. One-way analysis of variance (one-way ANOVA) was conducted to compare M. extensor digitorum and M. flexor digitorum superficialis activity during each time interval among groups. ANOVA was followed by Tukey posthoc comparisons to determine the intervals where significant differences did occur. A probability of $p < 0.05$ was selected to indicate statistical significance.

3. Results

After the fall of the clicker, all archers and non-archers presented an active contraction of the M. extensor digitorum. Elite, beginner and non-archers reached their maximum M. extensor digitorum contraction after about 100, 200 and 300 ms, respectively. The normalized value of the M. extensor digitorum contraction of elite and non-archers was significantly ($p = 0.010$) different at 300 ms after the fall of the clicker.

All archers showed a gradual relaxation of the M. flexor digitorum superficialis after the fall of the clicker. This relaxation was more rapid in elite archers than in

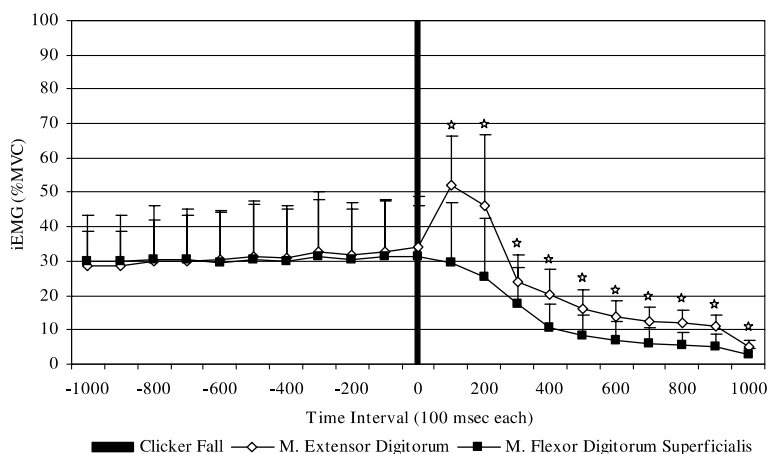

Fig. 3. IEMG values for elite archers (*the difference is significant at 0.05 significance level between MED and MFDS).

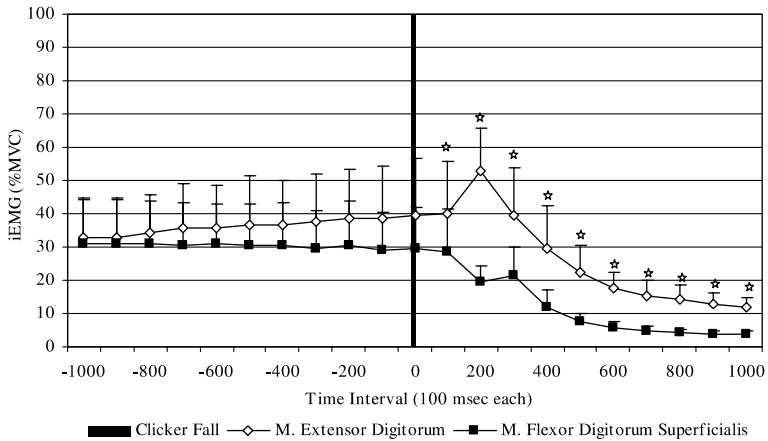

Fig. 4. IEMG values for beginner archers (*the difference is significant at 0.05 significance level between MED and MFDS).

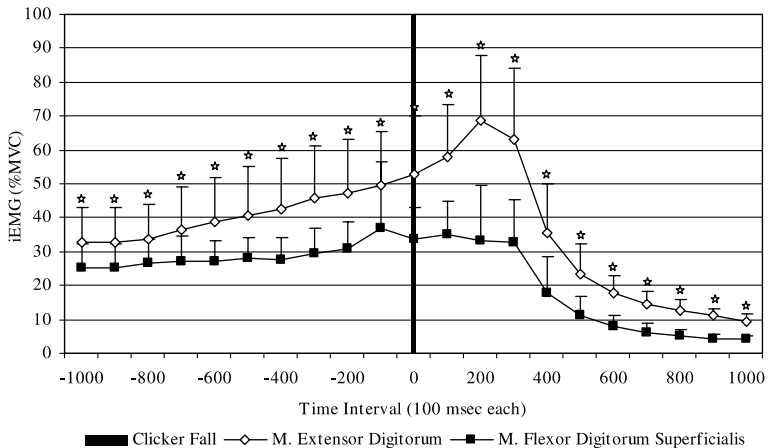

Fig. 5. IEMG values for non-archers (*the difference is significant at 0.05 significance level between MED and MFDS).

beginners and non-archers. Normalized activity of the M. flexor digitorum superficialis among elite and beginners ($p = 0.017$), and between beginner and non-archers ($p = 0.025$) differed significantly at 200 ms after the fall of the clicker. Normalized M. extensor digitorum and M. flexor digitorum superficialis activity of all archers and non-archers were significantly different ($p < 0.05$) during all time intervals after the fall of the clicker (Figs. 3–7).

Before the fall of the clicker, normalized M. extensor digitorum activity in non-archers was higher than in elite and beginner archers, but this difference was

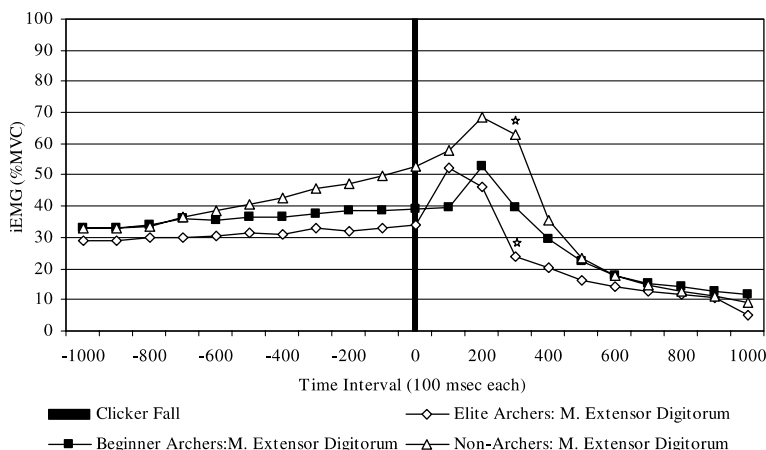

Fig. 6. IEMG values for elite, beginner, and non-archers for the MED activity (*the difference is significant at 0.05 significance level between elite and non-archers).

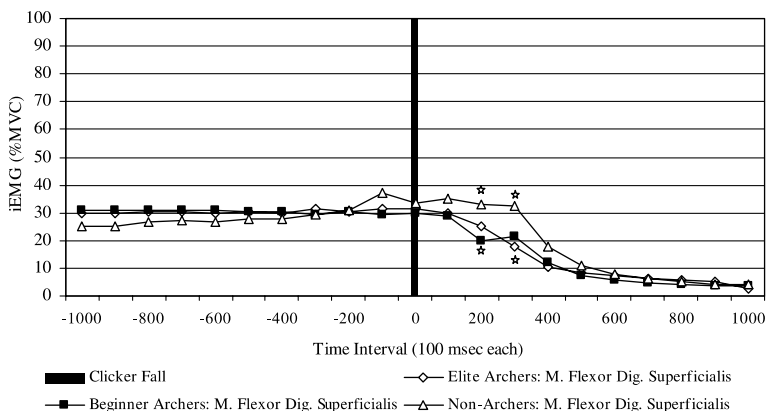

Fig. 7. IEMG values for elite, beginner archers, and non-archers for the MFDS (*the difference is significant at 0.05 significance level between elite–beginner archers and non-archers).

nit significant. The normalized activities of the M. extensor digitorum and M. flexor digitorum superficialis of the elite and beginner archers were almost constant and showed similar patterns. Non-archers’ M. extensor digitorum activity was significantly ($p < 0.05$) higher than M. flexor digitorum superficialis during all time intervals before the fall of the clicker.

One female elite archer, ranking in the first 10 archers of the World list, presented a significant decrease of M. extensor digitorum activity at 100 ms after the fall of the clicker. This decrease was significantly ($p < 0.05$) different from all other elite archers. This archer also presented a rapid decrease of her M. flexor digitorum superficialis activity compared to all other elite archers ($p < 0.05$).

4. Discussion

All archers and non-archers developed an active contraction of the *M. extensor digitorum* and a gradual relaxation of the *M. flexor digitorum superficialis* after the fall of the clicker. Active contraction of the *M. extensor digitorum* can be defined as a forearm and pull finger muscle strategy in archery. Nishizono et al. (1987) considered the *M. extensor digitorum* as the main muscle engaged in the releasing activity of the bowstring. Active contraction of this muscle was associated with a change from flexion to extension to release the bowstring (Hennessy & Parker, 1990). The results of the present study were in accordance with findings of Nishizono et al. (1987). The findings of the current study were also consistent with Martin et al.'s (1990) findings in that they did not support the popular teaching tenet that bowstring release by successful archers is achieved by a simple relaxation mechanism that is superior to one involving a more active response of finger extensors. Martin et al. (1990) conducted their study with 15 highly skilled archers, eight males and seven females. Their results for the flexor group muscles demonstrated that all subjects displayed a similar relaxation pattern. However, the results for the *M. extensor digitorum* muscle were characterized by two quite distinct EMG profiles. The first group of Martin et al. (1990) displayed the 'only flexor relaxation strategy' in contradiction to the subjects in the present study. The second group of their archers (7 out of 15) used the same extensor contraction strategy to release the bowstring as our subjects.

Elite archers' reaction to the fall of the clicker by *M. extensor digitorum* contraction was faster than that of the beginner and non-archers. Their release occurred about 100 ms after the fall of the clicker whereas the beginners' and non-archers' release took place about 200 and 300 ms after the fall of the clicker, respectively. These findings reveal a positive effect of expertise on forearm muscular strategy in archery. Non-archers displayed a preparation phase involving extensive extensor activity before the release of the bowstring, which was not observed in elite and beginner archers.

A three-finger hook in archery is a unique example of isometric forearm muscular activity in which a delicate pull and push balance should be established on the bowstring by coordinated action of *M. extensor digitorum* and *M. flexor digitorum superficialis*. Metacarpophalangeal, proximal and distal interphalangeal joints need to be fixed at a certain position. The balance between the normalized activities of *M. extensor digitorum* and *M. flexor digitorum superficialis* demonstrated in this study exemplifies this isometric forearm muscular activity before the fall of the clicker. The release occurs after the fall of the clicker. In order to react appropriately to the fall of the clicker, it is essential to develop a delicate coordination of *M. extensor digitorum* and *M. flexor digitorum superficialis* in the drawing arm.

In conclusion, it was established that archers develop a specific forearm flexor and extensor muscular strategy to accurately shoot an arrow to a given target after the fall of the clicker. Active contraction of the *M. extensor digitorum* and gradual relaxation of the *M. flexor digitorum superficialis* is an integral part of this strategy. Elite archers presented a faster reaction to the fall of the clicker than that of the beginners and non-archers.

Acknowledgements

We acknowledge the contribution of the Middle East Technical University through the Research Fund (Grant no: AFP 2000-050401). We thank to Mr. Gerald Perry, Dipl. Phys. Ed.; Dipl. Physiotherapist, from Doctor and Sport Institute, Universität Landau-Koblenz, Germany for his reviewing and giving feedback about our article.

References

- Clarys, J. P., Cabri, J., Bollens, E., Smeckx, R., Taeymans, J., Vermeiren, M., Van Reeth, G., & Voss, G. (1990). Muscular activity of different shooting distances, different release techniques, and different performance levels, with and without stabilizers, in target archery. *Journal of Sport Sciences*, 8, 235–257.
- Fédération Internationale de Tir à l'Arc (FITA). (1996). *Constitutions and rules*. Avenue de COUR 135, 1007 Lausanne, Switzerland.
- Hennessey, M. P., & Parker, A. W. (1990). Electromyography of arrow release in archery. *Electromyography and Clinical Neurophysiology*, 30, 7–17.
- Leroyer, P., Hoecke, V., & Helal, N. (1993). Biomechanical study of the final push–pull in archery. *Journal of Sports Sciences*, 11, 63–69.
- Mann, D. L., & Littke, N. (1989). Shoulder injuries in archery. *Canadian Journal of Sport Sciences*, 14(2), 85–92.
- Martin, P. E., Siler, W. L., & Hoffman, D. (1990). Electromyographic analysis of bowstring release in highly skilled archers. *Journal of Sports Sciences*, 8, 215–221.
- McKinney, W., & McKinney, M. (1997). *Archery* (8th ed.). Madison WI: Brown & Benchmark.
- Nishizono, A., Shibayama, H., Izuta, T., & Saito, K. (1987). Analysis of archery shooting techniques by means of electromyography. *International society of biomechanics in sports. Proceedings, Symposium V*, Athens, Greece.