



# FITA Coach's Manual

Intermediate  
Level

FITA  
Coach's  
Manual



FITA  
Coach's Manual



# FITA Coach's Manual

## **Forewords**







## Forewords

Dear Coaches,

As FITA President, I am very pleased with the second level Coaching Manual. For a sport to progress, coaches have to work with the athletes and for this they need the appropriate tools.

The success of the level one manual has shown that there is a worldwide need for this kind of tools. We are convinced that the level two will fulfil the same purpose and will make it possible for archers to advance in all of our member associations.

This manual was only possible thanks to the work of the FITA Coaches committee under the chairmanship of Ken Bearman and his two colleagues Kim Yung-Tak and Josef Preisser. Also all other coaches that edited and reviewed the manual, deserve the merit of this edition. A special thanks goes to our Development & Education Director, Pascal Colmaire.

Last but not least I want to thank the FITA Vice-President, Bob Smith and the Hacettepe Printing Department for the tremendous effort in making this manual.

Best regards.

**Uğur Erdener**  
*FITA President*

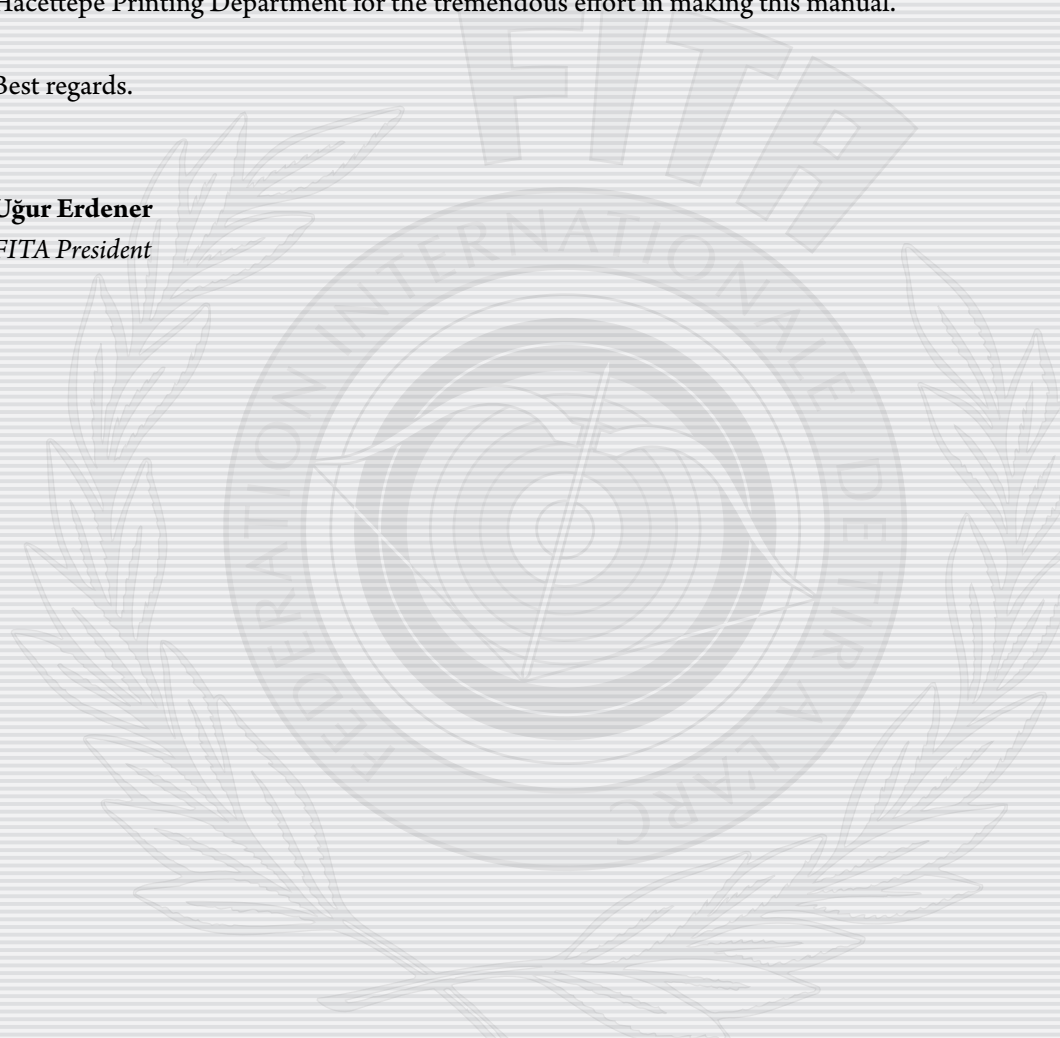



# Forewords

**D**ear Coaches,

When FITA was created there were two basic goals. Establish basic rules applicable worldwide and develop the sport. For the rules you need a rule book and this book has existed since the start of FITA in 1931.

However FITA had to wait till 2002 to get its first coaching manual for level one. Now in 2007 we are able to produce a second level manual and both of these manuals are essential for the development of the sport.

This also shows that Archery has progressed without these manuals but still we do need them for many reasons.

- To assist new or smaller member associations who do not have the resources to develop such toolkits
- To assist existing member associations to guarantee consistency in how archers are being formed and reduce the early drop-out that is a problem in many cases
- To assist by giving some new way of archery education
- To develop other disciplines of archery that might not yet be known in all of our member associations

We hope that this manual will help to evolve the coaching of our sport and FITA doesn't have the pretension to say that this is the only way. In archery there are several ways to get to the 10 and as long as it is a safe and healthy way we can only encourage you in your approach.

Enjoy the reading,

Use this tool and most important:

**TEACH IT TO AS MANY PEOPLE AS YOU CAN.**

Best regards,

**Tom Dielen**

*FITA Secretary General*

# Forewords

I have had the honour to be part of the development team producing this FITA Coaches Manual '2nd level' or 'Intermediate level' as we have come to know it, and now I have the pleasure of introducing this product to you.

The detail in this manual has been submitted by many of the top coaches and archers from around the world and gives a broad view of their thoughts and specialised techniques. With the writers of the articles coming from all of the five continents there were many views and methods of coaching and of development programmes etc. The team assembling the data have collated some of the differing ideas into the articles resulting in the finished manual you now have before you. What ever continent or Member Association to which you belong, there should be something in this manual that will help with the development of your coaches which will benefit your archers. As these coaches/archers skills develop their enjoyment level will increase. This enjoyment will develop enthusiasm which will become a display window for archery and help bring many new people into our sport.

The technical development of equipment is growing faster than it has ever done before; and we as coaches have to keep abreast of the technology that is helping to drive the scores higher and higher. The FITA office and the Coaches Committee are already contemplating developing the '3rd level' Coaches Manual.

Back to this 'Intermediate level' Coaches Manual, I would like to thank Pascal Colmaire for his enthusiasm in overseeing the inauguration of this manual, without his enthusiasm I'm sure this manual would still be in the production state. I would also like to thank the members of the FITA Coaches Committee who are Hyung Tak Kim – Korea, and Josef Preisser – South Africa, both of these coaches have dedicated hours of work to this manual and I truly thank them for the time they have given so willingly. Also, behind the scenes there is the staff in the FITA office that has helped enormously; I offer my gratitude and thanks to all these people.

May your coaching bring you and your archers the rewards you seek.

Best regards,

**Ken Bearman**

*Chairman – FITA Coaches Committee*

# Introduction

## Introduction

FITA strongly believe that some competition between the National Archery Coaching Certification Programs (NACCP) is good and can generate significant progress in archery coaching.

Countries without yet a National Archery Coaching Certification Program (NACCP) are strongly invited in developing one for their domestic use and growth. For that purpose, they can ask the authorization of using the NACCP from another country, or get “inspiration” from several ones.

On top of these alternatives these countries can also use the Coaching Education Materials produced by FITA, for their NACCP.

The FITA Coaches Committee has started in 2003 to produce some Coaching Education materials, with first a Level 1 Coaching Manual, then a Power Point presentation for assisting the Coaching Course Conductors in educating the novice coaches, then in 2004 the FITA Beginner Awards Program (BAP) and a Level 1 Coaching video in 2005. The countries without a NACCP yet, are invited to use these FITA Coaching Education Materials - if these items are relevant for educating their archery coaches. The FITA Member Associations wishing to use and/or translate any of these FITA Coaching Education Materials should contact the FITA office. They will receive a good assistance.

It is a pleasure to terminate a new FITA Coaching Education Material: the FITA Level 2 Archery Coaching “Manual”. Below you will find out the principle on which this curriculum has been developed.

The FITA Coaches Committee has identified three levels of coaching educations, briefly:

- **Level 1:** leading to the competencies in teaching a generic basis to the various archery forms to the novices.

*Note: The coach usually does not know what kind of bow and which disciplines the novices will practice in the future.*

- **Level 2:** leading to the competencies in “perfecting” the archery skills of the archers who have concluded the level 1 program and who wish to:
  - Become specialist with one bow division in one or two archery disciplines.
  - Start some local and regional competitions
- **Level 3:** leading to the competencies in training athletes in order to achieve the highest competition results, i.e. making training plan and ensuring its implementation. At this level, the coach should be able to make progressing various skills fields (Physical, Psychological, Technical...) in a predetermined duration (one year for instance).



## **Regarding The Level 2**

### ***Coaching objectives***

At this level 2, the coach has usually to take care of archers who have completed the level 1; hence have acquired a generic basis to archery. These “initiated” archers are now ready for choosing their own archery equipment division and archery disciplines; in other words, they need the assistance of a coach for getting specialized in one type of bow (Recurve or Compound or Barebow or Traditional bow) and one or two archery disciplines (for instance Outdoor Target during the warm season and Indoor Target during the cold season, or Outdoor Target and Field Archery).

### ***Modular format***

Pending the “sensibility” of his/her club, the coach will need a coaching specialization that meet the wish of specialization of the archers he/she has to take care of. This is why the FITA Coaches Committee has presented this curriculum under various “modules” allowing an education “à la carte” of the level 2 archery coaches. For instance a coach could have a use of the module “Archers with Disabilities”, because his /her club has always been open to this public due to some close relationship with a rehab center for instance. Another example: a coach could have no need of the Compound module, or the Field Archery Module, since in his/her country, only the Olympic form of archery is practiced.

Nevertheless the FITA Coaches Committee strongly suggests to all level 2 coaches to pass the following modules for delivering good coaching services: “ARCHERY ANATOMY, WARM-UP and PHYSICAL CONDITIONING” – “CODE of ETHICS” – “FIGHT against DOPING” – “PHYSIOLOGICAL BASIS of ARCHERY” – “PSYCHOLOGY” and “TRAINING PLAN”

It will be up to the FITA Member Associations that will use the FITA Level 2 Coaching material to make these modules mandatory or not.

### ***Profile of the archers to work with***

As already stated “At this level 2, the coach has usually to take care of archers who have completed the level 1...” – See “Coaching Objectives” above chapter for more details. On top of that, for elaborating the level 2 Coaching curriculum, the FITA Coaches Committee has also taken in consideration the following common profile of the archers at this level, met in many countries. At this level 2, the coach has often to take care of archers for whom archery is their main hobby. Most of them wish to become good archers, and for that purpose some of them – but not all of them - are willing to do “some” physical and/or psychological developments once in a while, but they wish to dedicate most of their free time for shooting arrows with a bow. Most of these archers will give a try to some archery tournaments, and some of them will compete regularly, but as “recreational competitors”. Due to the profile of

the level 2 archer, the “Sport Generic modules” such as Anatomy, Physiology and Psychology are just delivering some basic education to the coaches in the FITA level 2 curriculum. For learning how to develop / refine the skills from these sport fields (in other words, for “real” sport training), the coach will have to challenge the level 3.

### ***Importance of the level 2***

Many FITA Member Associations have reported a lack of coaching at the level 2, as a serious issue for the growth of archery in their country. It seems that in most of their archery clubs, the entry-level program (level 1) is usually properly ensured. But once this level completed, most of the “new” archers are facing a lack of guidance in equipment selection, equipment tuning, shooting skills advices, preparation to fist competitions, rules education, equipment maintenance ... until that:

- they drop archery for another sport, explaining a part of the huge turnover within some countries
- the best ones will join a regional team, where a coach will take care of them.

### Modules writing and quality

These Level 2 Archery Coaching modules have been written by some of the best world experts in the respective field. Hence you will notice several consequences; just to name few:

- The modules are built and written differently, pending their author
- The standard is pretty high!

Let me restate the biggest thanks from FITA to all contributors, from whom you will find the list and pictures in the printed version of this curriculum. Without their invaluable - but free – contribution to this long and important work, I don’t know how FITA would have been able to make this coaching material available.

As FITA Development (and Coaching Education) Director, I hope that these level 2 modules will help the FITA Member Associations in better educating their level 2 archery coaches and by consequence in better coaching their archers who have completed the entry level program, since these two (linked) objectives are among the highest priorities of the FITA Department I am in charge of. But also as an archery and coaching lover since ... a while!

Best regards to all the persons involved in archery coaching.

**Pascal COLMAIRE**

FITA Development and Education Director

# Contributors

## Contributors



**Caner Açıkada** (TUR)

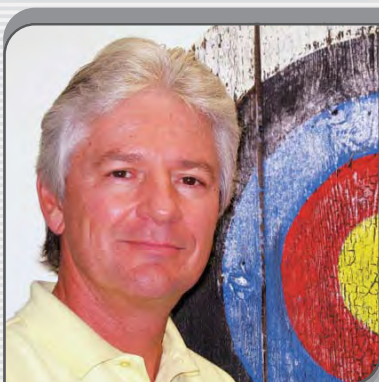

**Don Rabska** (USA)

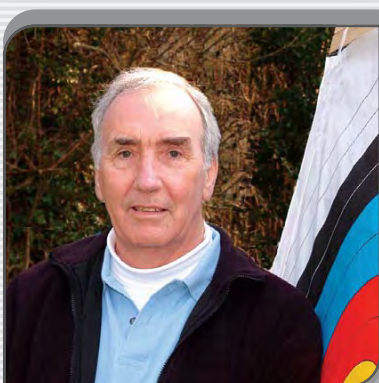

**Ken Bearman** (GBR)



**Tom Bil** (AUT)



# Contributors



**R. William Body** (USA)



**Matt Cleland** (USA)



**Pascal Colmaire** (FITA)



**Françoise Dagouret** (FITA)

# Contributors



**Lydie Depiesse** (FRA)

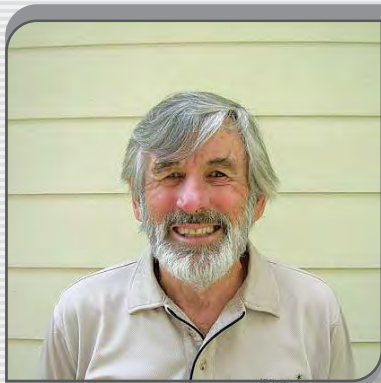

**Bruce Dillon** (AUS)



**Emin Ergen** (TUR)



**Helen George** (GBR)

# Contributors



**Josep Gregori** (ESP)



**Karole Hibner** (POL)



**NG Poh Khoon** (MAS)

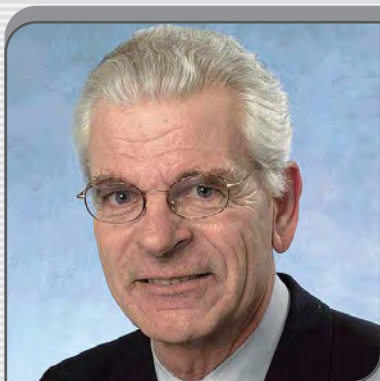

**André Korlaar** (NED)



# Contributors



**Viktor Mikhaylenko** (UKR)



**Tim Mumphy** (USA)



**Marjan Podrzaj** (SLO)



**Josef Preiser** (RSA)

# Contributors



**Alan Pritchard** (GBR)



**Bert Smith** (GBR)



**Kim Hyung-Tag** (KOR)



**Pako Verkoelen** (NED)



**Ann Web** (GBR)

Ann Web



**Bill Wee** (SIN)

Bill Wee



**Hakan Balci** (TUR)

Hakan Balci



**Robert C.W. Smith** (USA)

Robert C.W. Smith





# FITA Coach's Manual

## **CODE of ETHICS** Module





# FITA Coaching Manual

## Intermediate Level

### Module

## CODE of ETHICS

### Contents

<i>Preamble</i> _____	1
<i>Role of the Coach</i> _____	2
<i>Dignity</i> _____	3
<i>Integrity in Relationships</i> _____	4
<i>Professional Competence</i> _____	5
<i>Personal Standards</i> _____	6
<i>Confidentiality</i> _____	7
<i>Coach Responsibility</i> _____	8

#### 1. Preamble

Coaching within the sport of archery can contribute with the development of individuals in their chosen sport. It is used as a process for developing archery and coaching skills which when used will enhance the archer's ability, consistency and enjoyment of shooting the bow.

Every coach should respect and protect each person's human and civil rights, and should not participate in any unfair discriminatory practices or condone such activities.

It is essential to establish and maintain a standard of ethical behaviour what ever level of coaching is being undertaken. The coach should work within an agreeable ethical framework that is acceptable to them, the person they are coaching and the national guidelines of the country in which they are coaching. The principles of responsibility detailed in this document provide the basis of core values for good progressive coaching.

This code of ethics for coaching is a framework within which to work; and lists a series of guidelines rather than a framework of rules.

It is expected that archery coaches will encounter ethical standards in many areas; they must respect the integrity and confidentiality of the athlete at all times and reject any forms of abuse what ever level or guise this may take.

Coaches who adopt this code of conduct for coaches should accept the responsibility of the task they are un-

dertaking. This should include the responsibility toward the archer parent and family, and colleagues of the athlete, their employer and the organisation under which umbrella they are operating, i.e. club, county, country and FITA.

#### 2. Role of the Coach

**To gain respect you have to give respect, and when you give it make sure that it is genuine and sincere.**

Coaches play a vital role in the progressive development of their archers. How coaches communicate with the archer and the atmosphere they create often determines whether the interactive experience is beneficial or detrimental. Based on this, coaches should adopt a positive approach to coaching. This should be based on good common sense and incorporate several basic principles to teach the correct execution of the shot from the beginning.

- 2.1 Give plenty of praise and encouragement. When people are learning and refining newly adopted skills, coaches should provide plenty of genuine praise and encouraging statements that are related to the skills and performance of the archer.
- 2.2 Give praise sincerely. If coaches are not sincere with their praise and encouragement, they will lose their credibility with the archers they are coaching.
- 2.3 Develop and produce realistic expectations. It is imperative that coaches and their archers have realistic expectations that are based on each individual's abilities.
- 2.4 Give praise for effort as much as outcome. For some archers, winning events may be an unlikely achievement, but trying to succeed by giving maximum effort is attainable by all those involved.
- 2.5 Give praise for correct techniques and performance, not just outcome. Coaches should remember to encourage archers to improve their skills, they should also provide encouraging feedback to the archer when they have produced a good technique but are less than successful with the result. Winning at the expense of skill development will lead to failure at the more advanced levels of archery participation.
- 2.6 Employ a 'sandwich' approach to correcting mistakes. Such an approach focuses on providing a corrective instruction sandwiched between two positive and encouraging statements. Also by making the archer aware of the mistake, is often an opening for correction.

- 2.7 Coaches should adopt a positive and genuine approach to coaching.
- 2.8 A coach should help archers set realistic but challenging and attainable goals.
- 2.9 Coaches should ensure that training and practice are enjoyable and always end on a positive note.
- 2.10 Coaches should not expect children or juniors to perform as miniature adults but give consideration to their age, physical attributes and ability.
- 2.11 Coaches should help archers to define success by achieving personal goals that have been set by mutual discussion and agreement. These goals should be recorded so that they can be referred to through the progression of improvement and time.

### 3. Dignity

Safeguarding the dignity of the individual is a fundamental requirement of being a coach.

There shall be no discrimination between participants on the basis of race, sex, ethnic origin, religion, philosophical or political opinion, marital status or any areas that would be offensive or cause an aggravation to any person the coach is likely to come in contact with.

- 3.1 No practice constituting any form of physical or mental injury to the participants will be tolerated. All doping practices at all levels are strictly prohibited. Any form of inducement to indulge in, or partake in, any drug abuse will be contradictory to the Code of Conduct for Coaches.
- 3.2 All forms of harassment or abuse against participants or spectators; be it physical, mental, professional or sexual, are prohibited.

### 4. Integrity in Relationships

Coaches must not encourage archers to violate the rules laid down by the official organisation/federation governing that activity. They should actively condemn any such action and encourage archers to adhere to, and abide by the spirit of the rules.

- 4.1 Coaches should not compromise their archer's integrity by condoning any activity that would present an unfair advantage. The coach must encourage and actively pursue measures that progressively develops performance improvement in a safe and considerate manner and one that which will not jeopardise the archers well being for future performances.
- 4.2 It is the coaches' responsibility to ensure training and programmes they follow are directly relevant to

the archer and that they are in accordance with the age, ability and experience of the archer and will not cause any incapacitation.

- 4.3 The coach should be responsible for the conduct of their archers and must discourage any behaviour that would bring them, the archer or sport into disrepute, whether this is in training, travel or competition.
- 4.4 Coaches must treat all opponents with respect whether it is in victory or defeat, and should encourage their archers to act similarly. It is the coaches' duty to prepare their archer to respond to success and defeat in a cordial and dignified manner.
- 4.5 Coaches must be able to present any evidence of documented qualifications on request and must not refer to or display any item that falsely implies any sponsorship or accreditation qualifications.

### 5. Professional Competence

The coach should take the limits of their knowledge and capacity into account; and should not assume responsibility if they are not sufficiently prepared for the task at hand.

- 5.1 The coach should recognise and accept when it is necessary or appropriate to refer their archer to other coaches or sport specific specialists for further development. It is also their responsibility, where appropriate, to verify the competence of the person or organisation to which they are referring their archer.
- 5.2 Competence to coach should normally be verified by documented qualifications, or documented evidence of performance. Competence cannot be inferred solely from prior experience.
- 5.3 The coach must refrain from working in an environment that is unsafe or jeopardises the safety, or well being, of their archers or other participants.
- 5.4 Coaches should actively seek ways of improving their personal and/or professional development; they have a responsibility to themselves and their archers to improve their own ability and effectiveness.

### 6. Personal Standards

Personal appearance is a matter of individual preference and culture but a coach should project an image of cleanliness and efficiency; and not project an image that would offend either onlookers or the archers being coached.

- 6.1 Coaches must be aware of, and project an image of high standards of coaching to their archer, their archers parents and families, other coaches, spectators, officials and all other persons that may be in the vicinity or able to observe any activity being undertaken.
- 6.2 Coaches should never smoke when they are conducting a coaching or training session.
- 6.3 Coaches should not drink any alcohol just prior to conducting a coaching session. It may effect their decisions or competence to coach and may compromise the safety of the archers or spectators of the session. It may also be offensive to archers to smell alcohol on the breath of the person they are being coached by, and breathing out alcoholic fumes does not portray a very good image of a coach in charge of an important training session.

## 7. Confidentiality

When a coach has a good working relationship with an archer it is inevitable that a great deal of confidential information is interchanged and sometimes recorded. It is imperative that the coach and archer agree on which of this data is regarded as confidential, this confidential information must not be divulged to any person or persons without the express approval of the archer/parent or guardian.

Coaches must not disclose information entrusted to them in confidence. Any disclosure of information must not be for personal gain or benefit, nor be undertaken maliciously to damage the reputation of any person or organisation.

Some person, persons or organisations may have a need/right to have knowledge of some of this confidential information. It may fall on the coach to decide whether the disclosure of such information is in the best interest of the archer or sporting organisation. Some examples are listed below:

- Performance information for team or competition selection.
- Disclosure of information to doctors, the athlete's parents or family where the health or safety of the athlete may be in jeopardy.
- Disclosure of information to protect children or vulnerable adults from abuse.
- Disclosure of information for legal or disciplinary requirements.

## 8. Coach Responsibility

The basis of responsible coaching carries the expectation that activities carried out by coaches will be beneficial to the archers they are coaching, and to the sport in which they partake. The implementation of this coaching activity is to improve the archer's performance and at the same time minimising the risk of injury by ensuring their knowledge is current and all their training programmes are well prepared.

- 8.1 The coach should recognise and acknowledge their limitations and work within these limitations. They should accept the responsibility to refer their archer to other coaches or sports specific experts who have more advanced knowledge than them selves, and work with these people to enhance their archer's well being and/or performance.
- 8.2 The coach should strive to enhance their knowledge and coaching skills through research and personal learning projects, and to ensure their training programmes enhance their archer's well being and/or performance and does not harm or hinder them in any way.
- 8.3 The coach must be responsible for their archer or team and themselves in the pursuit of professional competence both in training and competition through well balanced and appropriate training programmes.
- 8.4 The coach must ensure that all training exercises and training programmes are appropriate for the person they have been designed for, and take into consideration, age, health, ability and experience of that person.
- 8.5 The coach must take into consideration the individuality and ability of each team member when constructing training exercises or training programmes.
- 8.6 The coach must constantly monitor their archer's physical and mental condition and take the necessary or appropriate action, and to take this into consideration when overseeing training exercises or constructing training programmes.
- 8.7 The coach must be aware of every day pressures the archer may have, such as; educational, occupational, and family or financial, and adapt their actions, instructions and training programmes accordingly.
- 8.8 The coach must consider the archer's well being and future development when making decisions on whether the archer can continue competing if suffering from a minor injury, fatigue or minor ailment. It is imperative that the well being and future development of the archer are put before current performance.



FITA  
Coach's  
Manual

**ARCHERY ANATOMY,  
WARM-UP,  
and PHYSICAL CONDITIONING**  
Module

Intermediate  
Level

Module

**ARCHERY ANATOMY,  
 WARM-UP,  
 and PHYSICAL CONDITIONING**

Contents

<b>I. Archery Anatomy</b> _____	2
1. <i>General anatomy</i> _____	2
a) <i>bones, joints, and muscles</i>	
b) <i>mechanics in muscle action</i>	
c) <i>balance in muscle action</i>	
2. <i>Important muscles of the shoulder girdle and the back</i> _____	2
a) <i>deltoid muscle</i>	
b) <i>supraspinatus, infraspinatus, subscapular, major and minor teres muscle</i>	
c) <i>anterior serratus muscle</i>	
d) <i>major and minor pectoral muscle</i>	
e) <i>major and minor rhomboid muscle</i>	
f) <i>latissimus dorsi and trapezoid muscle</i>	
g) <i>biceps muscle</i>	
h) <i>triceps muscle</i>	
i) <i>collaboration of these muscles when shooting</i>	
3. <i>Other muscles used in archery</i> _____	7
a) <i>muscles of the neck</i>	
b) <i>muscles of fingers and hand</i>	
c) <i>deep grip versus shallow grip (release hand)</i>	
d) <i>high grip versus low grip (bow hand)</i>	
e) <i>muscles of the legs and buttocks</i>	
f) <i>square stance versus open stance</i>	
<b>II. Warm-up exercises</b> _____	10
1. <i>Reasons for warm-up exercises</i>	
2. <i>General exercises outside the shooting range</i>	
3. <i>Exercises right before shooting</i>	
<b>III. Simple exercises for the shoulder girdle</b> _____	10
1. <i>General (isotonic/isometric?)</i> _____	10
2. <i>Special exercises</i> _____	11

**I. Archery Anatomy**

**1. General anatomy**

To get a clear picture of what is actually happening in our body, what anatomical structures are involved and how they cooperate during the performance of a shot we first need to know some basic anatomical knowledge from which we may derive special exercises to improve scores, to prevent injury or even to treat minor problems.

Basis of the human body is the skeleton with bones, articulating in joints, surrounded by more or less specialized soft tissue (ligaments, capsules) and muscles, and finally covered by the skin. Running in between and inside these tissues and finally penetrating into them we find nerves, arteries and veins. Organs are located in three cavities: skull, chest cavity, and abdomen. For archery anatomy we may concentrate on bones, joints and muscles and leave out the other structures mentioned, they are of more interest in sports physiology.

There are a few names used for describing the different positions in anatomy which are helpful for a better understanding of the following and should be known; they are:

- proximal = closer to the centre of the body; example: the shoulder joint is proximal to the wrist joint;
- distal = further away from the body centre; example: opposite of the above;
- lateral = more to the outer side; example: the shoulder joint is lateral to the neck;
- Medial = more to the inner side; example: opposite of the above.
- posterior = further back; example: the spine is posterior to the navel
- anterior = further to the front; example: the opposite of the above

As bones and joints are “passive” structures we need muscles to get them moving. Muscles can only pull and bring two points (origin and insertion) through which they are attached to the bone closer together. Muscles cannot push, although an archer is often told to “push the bow arm towards the butt.” Origin as well as insertion need not be limited to a small spot; it can be a line or any larger area. We refer to the origin as the fixed point and to the insertion as the moveable point. For example, contraction of the biceps muscle of the upper arm moves the hand upwards towards the shoulder; the origin of the biceps muscle is fixed through two tendons at a front part of the shoulder blade, it inserts with one tendon at the forearm close to the elbow joint.



The position of the whole muscle in relation to the joint it moves gives a good understanding of what the muscle in fact does. Same example, the biceps muscle is located on the front side of the elbow joint, thus it will bend this joint to the front.

Obviously, there must be muscles on the opposite side of that joint to bring the bones back to their original position or move bones to the opposite side. In our example this would be the triceps muscle which is located on the posterior side of the upper limb, thus it will stretch out the bent elbow (bending to the back side is not possible due to the shape of the elbow joint).

Muscles which perform movement in opposite directions of another muscle are called *antagonists*, whereas muscles that help together for a certain movement are called *synergists*. If a single muscle (*agonist*) is contracted the antagonist has to relax and vice versa. If that does not work properly it will result in cramps where (almost) no intended movement can be achieved.

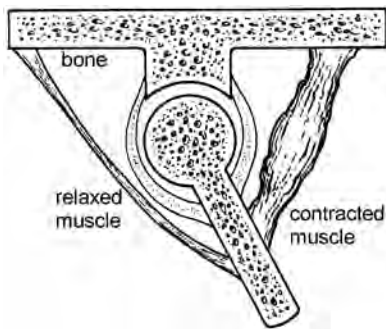

To be able to stand straight or to keep our body in a balanced posture, no matter if standing or lying down, muscles have a certain basic tension which can consciously be influenced and altered. If, through exercises, one muscle is well trained the antagonist will become relatively too weak; such an imbalance is then followed by a change in the usual joint posture. Knowing this, we should always recommend strengthening not only the agonist but also the antagonist, as well as symmetrically both sides of the body, to keep the balance.

For archery, our main concern points towards bones, joints and muscles of the shoulder girdle. Although a lot of different anatomical structures are listed and described below they do not work isolated but cooperate in several ways, depending on different joint positions.

The basis of the shoulder girdle is built up by the upper part of the chest cavity (consisting out of spine, ribs and sternum), shoulder blade and clavicle (see picture below, seen from top of a human being).

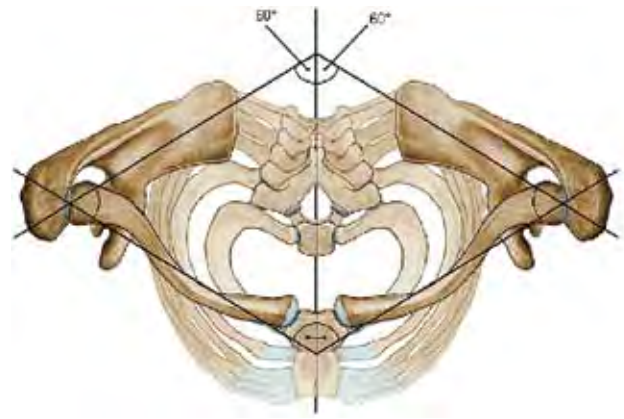

Arising from the shoulder blade we have the socket for the upper arm to build the shoulder joint. This joint is, due to a rather flat socket, very generously constructed to provide a maximum range of movements for the arm. It is possible to raise the arm sideways (we call that *abduction*) almost to the horizontal level without involving any movement of the shoulder blade itself. Further abduction needs movement of the shoulder blade as the upper arm is pushing against the *acromion* (highest and most outward point of the shoulder blade). Dislocation of the upper arm out of the socket at such generous movements is avoided through the rotator cuff, a strong capsule around the joint. The rotator cuff will be held under tension through the supraspinatus muscle so that it cannot be squeezed through the bone structures during movement, particularly on abduction.

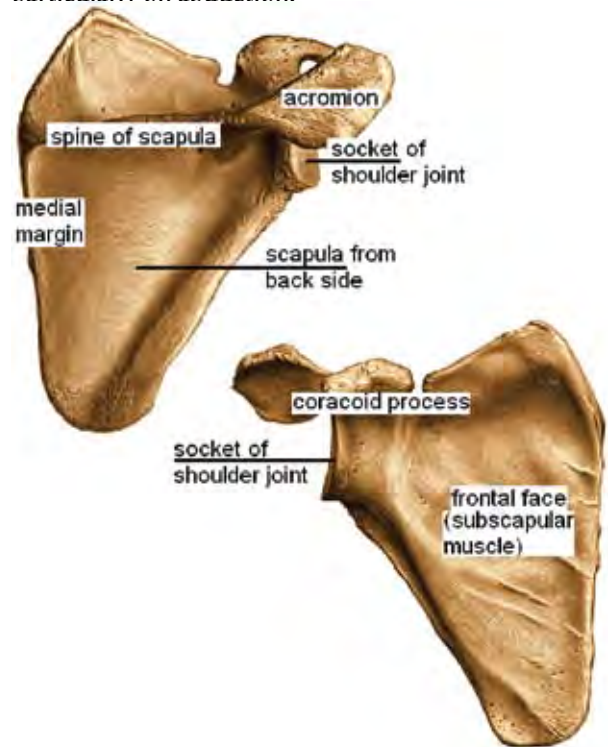

## 2. Important muscles of the shoulder girdle and the back

We distinguish several muscle layers between skin and rib cage where the bigger and larger ones more or less cover the smaller ones; it should also be kept in mind that muscles very rarely work on their own, a movement mostly involves several muscles at the same time, sometimes they achieve different movements when a joint between two bones has changed its position.

Like describing different positions with special names we also have special names for describing certain movements in anatomy; they are:

- Abduction: away from the body to the side; example, raising the bow arm to the side;
- Adduction: towards the body, coming from the side; example, the opposite of the above;
- Ante version: away from the body to the front;
- Retroversion: away from the body to the back;
- inward rotation: explains itself;
- Outward rotation: explains itself.
- Deltoid muscle: it covers the shoulder joint like a cap, its origin goes from the spine of the shoulder blade over the acromion to the clavicle; it inserts at the proximal end of the upper arm.



Main movements: abduction (the strongest muscle to do that), inward and outward rotation (depending what part of the muscle is activated).

- Supraspinatus muscle: originates in the groove over the spine of the shoulder blade and inserts also at the proximal part of the upper arm.

Movements: it mainly prevents a squeezing of the rotator cuff during abduction of the arm, and helps a little for this movement.

- Infraspinatus muscle: originates at the area below the spine of the shoulder blade and inserts also at the upper arm.

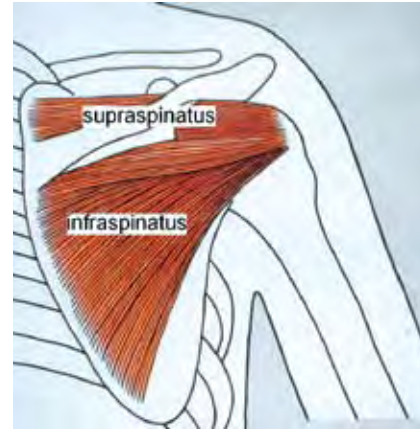

Movement: the strongest outward rotator of the arm.

- Major Teres muscle: originates at the lowest medial and posterior part of the shoulder blade and inserts also at the proximal upper arm.

Movement: inward rotation, adduction, retroversion

- Minor teres muscle: coming also from the posterior medial part of the shoulder blade and going to the proximal part of the upper arm.

Movement: inward rotator.

- Subscapular muscle: originates from the frontal side of the shoulder blade and inserts at the proximal part of the upper arm.

Movement: the strongest inward rotator; it also prevents squeezing of the rotator cuff.

- Serratus anterior muscle: originates from the 1<sup>st</sup> to the 9<sup>th</sup> rib, passing alongside the chest cavity and inserts at the medial frontal edge of the shoulder blade.

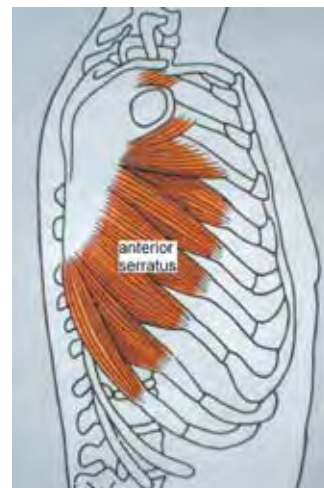

Movement: pulls the shoulder blade forward, lowers and rotates it; the only muscle which can actually pull the bow arm towards the target.

- Major pectoral muscle: coming from the clavicle and sternum (1<sup>st</sup> to 5<sup>th</sup> rib), going to the proximal part of the upper arm.

Movement: mainly adduction of the arm and inward rotation.

- Minor pectoral muscle: originates at the 3<sup>rd</sup> to 5<sup>th</sup> rib and inserts at the coracoid process of the shoulder blade.

Movement: moves the shoulder girdle more to the front.

- Major and minor rhomboid muscles: they originate from the spine (from the 6<sup>th</sup> cervical down to the 4<sup>th</sup> dorsal vertebra) and insert at the medial edge of the shoulder blade. They are situated in the layer below the trapezoid muscle.

Movement: they pull the shoulder blade a little upwards and towards the spine. They are actually responsible for “squeezing the shoulder blades”.

- Biceps muscle: it originates at the front part of the shoulder blade with two tendons, one at the socket of the shoulder blade, the other one at the coracoid process; it inserts at the forearm (ulna and radius) near the elbow.

Movement: it is the strongest muscle to bend and outward rotate the elbow joint. It also does the ante version of the arm.

- Latissimus dorsi muscle: the widest back muscle we have, originating from the spine (from the 6<sup>th</sup> dorsal vertebra down to the sacrum) and part of the dorsal hip bone; it converges to the proximal part of the upper arm. On its way up there it presses the shoulder blade against the rib cage.

Movement: strong adduction, as well as inward rotation and retroversion.



- Trapezioid muscle: also a wide muscle, originates from the lowest posterior part of the skull, over the spine (down to the 12<sup>th</sup> dorsal vertebra); it inserts at the lateral part of the clavicle, at the acromion and at the spine of the shoulder blade.

Movement: the top part of it raises the shoulder blade whereas the bottom part lowers it; it also squeezes the shoulder blade towards the spine.

- Triceps muscle: it originates from the bottom part of the shoulder joint socket (still at the shoulder blade) and from the proximal part of the upper arm, inserts at the back side of the elbow (ulna). It stretches the elbow joint.

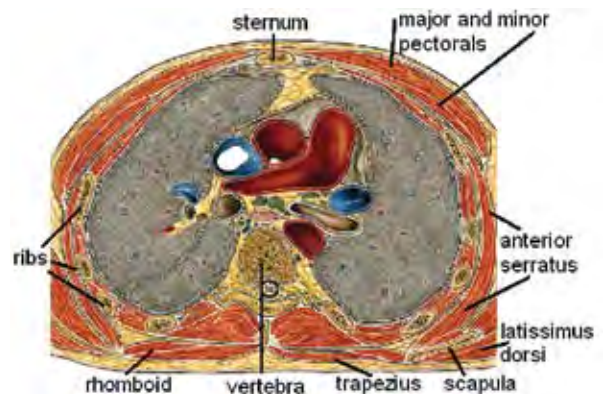

The above picture represents a horizontal cross section through the body at approximately slightly below the spine of scapula. It gives a good impression how muscles are located and interlaced in the body. In the centre the big blood vessels (blue and red) between the two halves of the lungs can be seen. The most important, archery relevant anatomical parts are named.



### **Collaboration (in general) of these muscles when performing a shot:**

- a) The bow arm side: Raising the bow arm is mainly achieved by the deltoid muscle, the triceps muscle will keep the bow arm (elbow joint) stretched. “Pushing towards the target butt” solely lies in the responsibility of the anterior serratus muscle as it pulls the shoulder blade forward; as the clavicle prevents the shoulder blade from being moved just around the chest cavity to the front side the resulting movement actually pulls the shoulder blade and with it the bow arm in the direction to the target. At the same time the rhomboid muscles as well as the trapezoid muscle as antagonists have to be relaxed (therefore no squeezing of the shoulder blade towards the spine on the bow side). To prevent the shoulder from becoming “high”, mainly the latissimus dorsi muscle is activated. Major and minor teres muscle, as well as subscapular muscle rotate the arm inwards which prevents the elbow and forearm from being touched by the string on release (thus it is a rotation in the shoulder joint which brings the elbow out of the way of the string; the elbow itself can just be bent or stretched). The minor pectoral muscle moves the shoulder girdle of that side up to a certain extent more to the front so that the centre of the shoulder joint (“A” in the picture below) comes closer to the line between anchor point and pivot point at the bow handle (“B” – “C” in the picture below); this alleviates the back muscles their work in compensating for the force vector created in this latter line (B – C); twisting the trunk a little clockwise (seen from top; with right-handed archers) can even increase this mechanism from a physical point of view, because the line through the centre of both shoulder joints gets more parallel to the line A – B, thus giving relief to the back muscles for their work against the force coming from B.

Beginner archers tend to bring the bow shoulder too much to the front without sufficient inward rotation of their bow arm, thus suffering from painful hits of the string on the elbow.

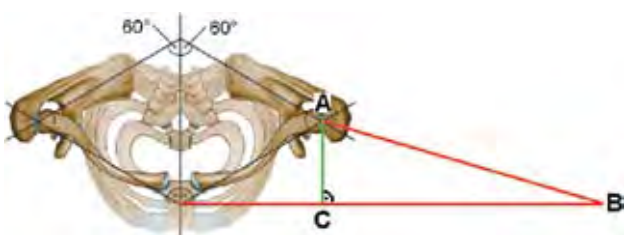

- b) The string side: Biceps (for the elbow bend) and major pectoral muscle bring the arm towards the string so that the fingers (with or without mechanical release) can take hold of it; at the same time the deltoid muscle (and to a minor degree also the supraspinatus muscle which mainly prevents the rotator cuff from being squeezed in between acromion and most proximal end of the upper arm) is activated so that this happens in an approximate horizontal level. (The activities of the finger muscles and where they are located is described below in the next paragraph). To pull the string back to the anchor point several muscles are now working together: the trapezoid and rhomboid muscles move the shoulder blade towards the spine, mainly the posterior part of the deltoid muscle and the infraspinatus muscle lead the upper arm backwards so that the elbow comes as close as possible to the extension of line B – C (see picture above). The middle part of the deltoid muscle keeps the drawing arm in the horizontal level or above. While pulling the string back and coming to full draw the muscles situated on the back side of the shoulder joint are holding against the draw weight of the bow, also the muscles which bend the fingers must work as otherwise the string or a hand-held release would slip out of them, as well as part of the biceps muscle and a few smaller muscles.

To overcome the peak weight some compound archers move their elbow closer to the trunk and downwards. They do this instinctively to use additional muscles and to strengthen the pulling muscles in using a more effective position. The peak weight has to be overcome in a rather unfavourable position for the shoulder joint and muscles. The angle between upper arm and the line through both shoulder joints has not yet reached 90°, so that the muscles which have to pull further are still much elongated and have to battle with a long lever (upper arm) as well as a poor physical relationship between their origin and insert. In bringing the elbow closer to the trunk firstly the lever situation of the pulling muscles is improved and secondly the strong biceps muscle assists to overcome the peak. This simple trick helps to pull further back but is bad form. Moreover, the hand holding the release will be moved downwards, and whilst the bow hand is still keeping its position, this could have a disastrous effect: in case the string loop or the rope of the release would break just in this moment the arrow would be shot way over the tar-

get and might cause an accident. So, not to run any risk, we should either teach such archers to do special muscle exercises to become capable of pulling the string back in a horizontal level or we should convince them of reducing their draw weight.

### ***Differences between recurve and compound archers at full draw:***

When just simulating the position at full draw the back of the hand normally would point upwards.

- With recurve archers the hand has to be twisted outward (so-called supination) which is achieved by a small muscle called supinator muscle (situated at the two bones of the forearm near the elbow joint) which is assisted by the biceps muscle.
- When shooting a wrist-strap release these muscles are relaxed as the back of the hand is in its natural position.
- When shooting a hand-held release normally the hand is rotated inwards (so-called pronation) to bring the back of the hand with its knuckles towards the jaw bone. This action is done by two small muscles namely pronator teres and pronator quadratus muscle. Obviously, the biceps muscle has to be relaxed to make this inward rotation possible.

The above said shall serve as just a rough description what happens with arm and shoulder muscles when performing a shot. Also other muscles of the trunk come into play but don't have such a big role in that game.

### **3. Other muscles used in archery**

- a) Muscles of the neck: in the neck area we have a lot of small muscles which provide for turning the face towards the target, but (to keep it as simple as possible) the main rotator muscle of the head shall be mentioned, this is the sternocleidomastoid muscle; it originates at the sternum and medial part of the clavicle, its insertion is at the lower back side of the head, the so-called occiput. Tension of the right sternocleidomastoid muscle turns the head to the left and vice versa.
- b) Muscles of fingers and hand: There is a whole bundle of muscles coming from the elbow and converges towards the hand and fingers. These are the major muscles for moving fingers and wrist joint. Of course, there are several others more, smaller muscles which originate at the proximal end of the fin-

gers and metacarpus, and insert at their most distal end. In general, all muscles located on the palm-side of the hand bend the fingers; those situated on the back-side of the hand will stretch them.

- c) Deep grip versus shallow grip (release hand): when holding the string at full draw: holding the string with just the finger tips needs an extreme tension of those muscles bending the fingers, otherwise the string would slip away before it should. The release then happens out of a very tensed condition; in contrast, using a deep finger grip the lever between the finger joints becomes more effective, thus needs less tension. Although the way of the string around the entire end part of the holding fingers is now longer, the release happens out of a much less tensed status and therefore will be smooth, see picture below.



- d) High grip versus low grip (bow hand): if the bow hand is kept relaxed the archer will perform a low grip where the thumb ball is pressed against the grip of the handle. The tension in this ball may vary from day to day, depending on the overall physical condition on a day; if that condition is good, the tension will also be good and vice versa. With a poor tension in this ball the "way through the clicker" might become longer and longer. In compound archery this issue does not play a role as they normally do not use a clicker. Also, with a low grip the pressure point is further away from the arrow rest.

Should the archer decide for a high grip they additionally have to apply tension on those muscles which bend the wrist joint. This tension has to be kept equally from shot to shot which needs a lot of practise to achieve that. Moreover, all other muscles which can move the wrist joint have to be tensed in order to stabilize the wrist joint during the whole shot performance. With a high grip the pressure point is closer to the arrow rest (see x-ray pictures below).

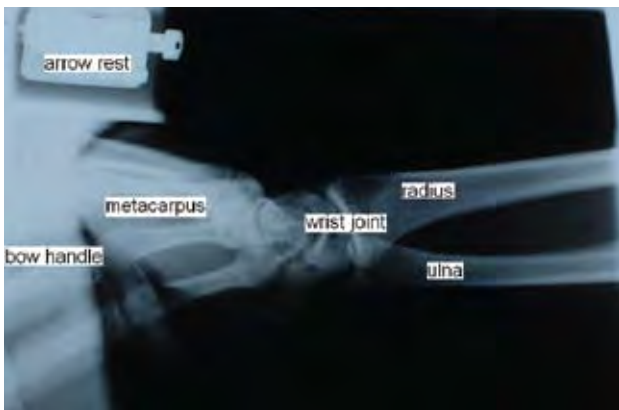

*Low grip**High grip*

Differences between recurve and compound archers with their release hand:

- The recurve archer is supposed to relax the tensed fingers to let the string go. The fingers open passively, this is not an active opening of fingers; it is as if a bucket full of water or sand is just incidentally slipping out of the tensed fingers. Super slow motion pictures have shown that the fingers are almost immediately slightly bent again when the string has moved forward just a few centimetres.
- Compound archers may use two ways of getting the trigger going:
  - I. They keep a certain tension in their trigger finger to form it like a stiff hook; then they increase back tension and pull more and more against the wall until the trigger goes; if a wrist-strap release is used the strap will squeeze the skin and slide slightly towards the wrist joint; thus the stiff trigger finger is moved towards the trigger of the mechanical release and finally gets it going. With a hand-held release, for example a thumb release, most probably the fingers holding the mechanical release will open slightly or, also thinkable, the capsule (soft tissue) around the wrist joint and

the capsule around the joints between holding fingers and metacarpus will be elongated a little to enable the stiff trigger finger to move towards the trigger of the mechanical release. Most top archers prefer this way of using a mechanical release. What really happens (is there a subconscious movement of the trigger finger or not?) is still to be examined and sorted out by neurological research.

- II. Another way to use a mechanical release is to keep up back tension and use the trigger finger, no matter if wrist-strap release or hand-held release is used, like a rifle shooter, shall mean consciously bend this trigger finger on purpose when everything is done right and the archer feels ready to let go.

- e) Muscles of the legs and buttocks:



The main muscles are the gluteus maximus muscle, quadriceps femoris muscle, biceps femoris muscle, triceps surae muscle, anterior tibialis muscle and several others smaller muscles which should not expressively be mentioned in this manual.

Obviously, these muscles help together in achieving a firm stance, tighten the joints of the lower leg.

- f) Some coaches recommend a square (classic) stance, others an open one. Human beings are extremely

logically and economically built up. The square stance needs the least effort in muscle activities.

Let's imagine a person standing relaxed in upright position in front of us; if we draw a line through the centre of the hip joint, the knee joint as well as the ankle joint then this line would be perfectly straight (it is called "Mikulicz line"); of course, this is valid for both legs in a healthy person. If we draw then another line through the centre of both hip joints the angle between this line and the Mikulicz line is  $90^\circ$  on either side, and finally, the spine is resting again in a  $90^\circ$  angle on the centre of this horizontal hip line.

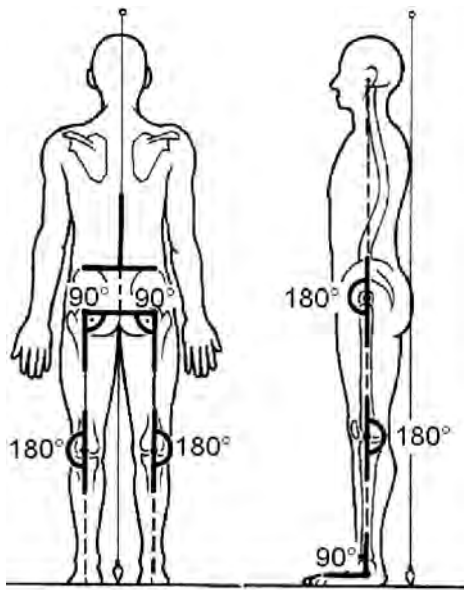

As seen from the side also a straight line would run through the ankle joint, hip joint and through the ear up to the vertex. The weight distribution is approximately 60-70% on the heel, 30-40% on the front foot. This person's stance is then in complete balance with almost no muscular effort. Bringing the feet "shoulder width" apart would increase the area of stance, thus making it more stable without any extra strain.

The balance of this stance will be slightly disturbed by holding a weight of about 2 kg (the bow with accessories) on the stretched out, abducted arm. This will bring more load to the leg of the bow side, the trunk tends to get bent to the bow side, thus the trunk muscles of the string side have to compensate for that imbalance. The main muscles to achieve that reach from the hip bone and run more or less parallel to the spine up to the neck have several origins and insertions on their way; they belong to the so-called longitudinal muscle system of the back, represent the deepest layer of back muscles. Obviously, these muscles are also important in field archery with uphill and/

or downhill shots to achieve the necessary bending of the trunk to keep the shoulder girdle in line with the target.

With an open stance the situation is completely different as there is extra muscle strain to bring the body out of balance on purpose. The top part of the trunk, the shoulder girdle, cannot be rotated (or just very slightly), thus the position of the shoulder blades and arms stays the same as with the classic square stance (they are in line towards the target). Yet, the location of the feet has been changed, so there must be a rotation of the body in between the feet and the shoulder girdle. All joints located in between will be involved as the body always strives for harmonic balancing of any imbalance. There will be a slight rotation in the ankle joints and knee joints, more rotation is possible in the hip joint of both sides as well as in the little joints between the lumbar vertebrae (the ribs prevent major rotation in the chest region of the spine). The rotation causes asymmetric strain on ligaments around and cartilages in the joints. Mostly, the archers also lean their upper body forward which leads to a weight distribution of 60-70% on the front of the foot\* and 30-40% on the heels.



*Deep back muscles (left) and their force vectors (right.)*

In theory it is thinkable that the inward rotation of the bow arm (remember latissimus dorsi muscle above) is supported by an open stance as through the body rotation this muscle becomes a little elongated (the upper part of the chest cavity rotates away from the hip bone on the bow side), thus more effective. So far, there is no proof but should be considered possible that this way of standing has negative effects on the skeleton (towards a

scoliosis) when shooting 300 – 500 or more shots per day over a period of several years.

## II. Warm-up exercises

In archery we usually don't have a lot of movement during a competition. Our sport is considered to be static. Therefore it is recommendable to do warm-up exercises to compensate at least partly for the side effects of long lasting standing.

Effective warm-up exercises increase the body's capabilities, performance in training and competition will become better. Through warm-up exercises the circulatory system, bones and joints, as well as the muscles are prepared for the coming stress, not to forget the positive effect on the psyche in reducing anxiety and possible lack of self-confidence ahead of a coming event.

Moving larger muscle groups in warming-up exercises increases the body temperature, blood will be drawn out of the digestive system (that's why you should not practise or compete right after a meal), the blood vessels will be widened, thus the circulatory situation in the muscles as well as in the brain will improve thus more oxygen is available. Improving the circulation is particularly necessary to prevent trouble with the veins as the blood flow normally slows down during long lasting standing.

With increased body temperature resistances within the different tissues will be decreased, the archer will be able to stretch better, to tense their muscles better, and to get more stamina. Stretching exercises will increase the range of motions. Outside the shooting range jogging, swimming, cycling, dancing, stepping or cross walking are recommendable exercises. On the shooting range the facilities for using machines are limited; therefore warming-up should be kept as simple but also as effective as possible.

The following exercises shall be considered a suggestion; everyone may change them or include different exercises in their own program; where possible all following exercises should be done on both sides:

- Jogging on the spot, alternating slowly and quick; side jumps with both legs to the right and left.
- Take a long step forward with one foot, bend the knee of the front leg, and stretch the back leg out straight behind you as far as possible, keeping the heel on the ground.
- Standing in upright stance, arms stretched out above the head, holding on to one thumb and stretching over the other side.

- standing on both legs, keeping your thighs together, bend one leg in the knee, take hold of the foot in front of the ankle, hand and foot pulling against each other; feeling the stretch in the thigh
- standing in upright stance; arms stretched out to your side shoulder level, alternating palms facing down and palms facing up (shoulder rotation)
- Stand with your legs fairly wide apart, feet parallel, twisting in the hips bringing the upper body over one leg to reach the calf or the ankle with the hands.
- Standing in upright stance; left arm stretched out towards the ceiling, right arm is bent in the elbow, right hand holds on to the left elbow, gently pulling the left arm behind the head.
- Standing with the legs fairly wide apart, feet parallel, reach down with the hands to the floor, making sweeping motions in front of you from side to side.
- Standing in upright stance; keeping arms loose at your sides, rolling the shoulders forward and backwards.
- standing in upright stance; turn the head to the right, then to the left, then bring the chin towards the chest, lift the chin up until you see the ceiling; then bring the right ear towards the right shoulder and then left ear towards the left shoulder. Never combine these three separate motions into one uncontrolled circulation to avoid harm for the cervical spine.
- Standing in upright stance; arms stretched out in front of you shoulder level, alternating a fist and a stretch in the fingers.
- Standing in upright stance; hands in front of your chest, fingers interlaced, bending and stretching both wrist joints alternatively.
- Standing in upright stance, firmly on only one leg; circulate the foot of the other leg in the ankle joint, start with clockwise and change then to counter-clockwise motion.
- Close with a final jogging on the spot.

## III. Simple exercises for the shoulder girdle

### 1. General

Muscle exercises will increase the basic strength of muscles, improve the speed of contraction, and also increase the local and dynamic endurance. After a certain period of exercises the amount of contractile proteins (Actin, Myosin) will be increased so that the maximum strength per cm<sup>2</sup> will also increase.

Basically, there are four ways of building up muscle strength, either isometric or dynamic (or isotonic), ec-

centric and isokinetic. The most important ones for our purposes are isometric and dynamic. With isometric exercises there is no change in the position of a joint, the exercise consists out of an attempt to move something. For example, to build up the biceps muscle the trainee sits in front of an extremely heavy table and tries to lift it up. The biceps muscle will be tensed at its maximum, but the table can't be moved. These exercises should be held for some seconds. If held for too long the energy supply in the muscle cells will become uneconomic, thus muscle sore will result but not necessarily increase of strength. The ability to hold a certain weight or load for a certain time depends on the maximum muscle strength. Is the load not more than 15% of what could be held at the most, it could be held more or less in eternity. Is the load increased to 40% it can only be held up to about 2 minutes. The reason for this decrease in time is that the blood (and thus oxygen) supply of the muscle decreases due to an increase in pressure inside the muscle fibres. The maximum effect in isometric muscle exercises will be achieved when approximately 70 – 80% of the maximum muscle strength is used and held for not longer than 6 – 7 seconds (alternatively: maximum load held 3 – 4 seconds); it is enough to do 3 – 5 such contractions per muscle per day. An advantage of the isometric exercises is that every muscle group can be built up according to our needs, and such exercises take just a few minutes per day.

In dynamic (or isotonic) exercises there is a movement, the position of a joint will be changed. Again an example for the biceps muscle: try to lift a heavy dumb bell just by alternatively bending and stretching the elbow joint. For isotonic exercises we normally recommend 12 repetitions and three sets of 12 repetitions with a break of 1 – 2 minutes in between. An advantage of the isotonic muscle exercises is that at the same time coordination is also improved as there is movement during contraction and relaxation.

## 2. Special exercises

Through the general knowledge we now have in anatomy simple but effective exercises to improve the strength of muscles of the shoulder girdle may be derived. Some archers are using a so-called "Thera-Band" or even the stronger "Deuser-Band", however, they don't have a suitable grip and they seem to be too easy for a healthy person to improve the muscle strength needed in top archery. Using dumb bells needs additional equipment like a bench or similar otherwise it would get rather tricky to train up

for example the back muscles. Some archers are using machines in fitness rooms on a regular basis which is, in principle, a good idea. However, it is the archery coaches' and not the responsibility of any owner of such centres to sort out exactly the necessary exercises for their students.

Besides, there are so-called chest expanders on the market available with which very efficient exercises to strengthen the shoulder girdle are possible. These expanders normally have five (rubber) strings in between two grips and provide for a wide range of exercises. They come out in different strengths, from 20kg up to 100kg, thus using for example just two strings on a 20kg expander will give you 8kg, and the same number of strings on a 100kg expander would then have 40kg at full draw. For a start the student should use as many strings as they can handle the exercises 2 – 3 times rather quickly but feels strain coming up thereafter. Working with expanders can be done everywhere, is cheap and still very effective.

The following program demonstrates seven simple exercises to increase muscle strength for the shoulder girdle; again, this shall just serve as a suggestion, everyone is welcome to create new, helpful exercises. It is indicated if these exercises are isometric or dynamic so everyone may derive the number of contractions and duration of training.

- a. Side push-ups (dynamic): this exercise is particularly strengthening the anterior serratus muscle. Place your feet against a wall or cupboard; the bow hand shall be placed firmly on the floor, the whole body as well as the elbow of the bow arm should be kept straight during this exercise; let the shoulder blade move towards the spine (simulating a high shoulder) and "push" it away from the spine alternatively. See figure 1.



Figure 1

- b. Bow arm inward rotation (isometric): place your bow hand on the frame of a door or similar, keep stationary; lock the elbow and rotate the upper arm inwards (clockwise for right-handed, counter-clockwise for



left-handed archers) so that the hollow of the elbow moves out of the way of an imaginary string. Do NOT just bring the shoulder forward closer to the imaginary string line. See figures 2 & 3.

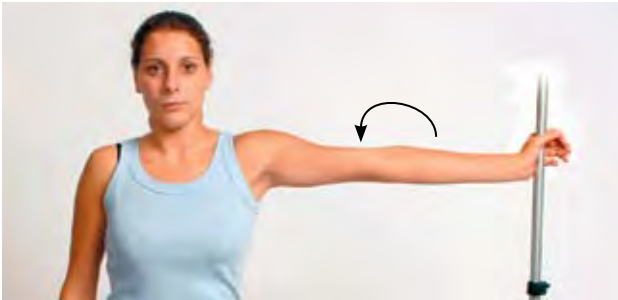

Figure 2



Figure 3

- c. Shoulder pull-down (dynamic): sit down, the legs straight in front of you; place your hands to your side and lift up your body. If your arms are too short to achieve sufficient lift-ups use a book or a brick under the palms of your hands to get better results. See figures 4 & 5.



Figure 4



Figure 5

- d. 1<sup>st</sup> expander exercise (dynamic): upright stance; arms stretched out with the hands above the head; keep the arms stretched and lower to shoulder level, pulling the expander apart sideways with strings in front of the chest, lower the arms until the expander is relaxed again. See figures 6, 7 & 8.





Figure 6



Figure 7



Figure 8

e. 2<sup>nd</sup> expander exercise (dynamic): in this exercise the expander is used behind the back; upright stance; one

arm is stretched out towards the ceiling, the other arm is stretched out towards the floor; holding on to the expander, stretch to your maximum and relax (simulates again a high shoulder on the side where the arm is stretched towards the floor). This exercise should be done on both sides. See figures 9 & 10.



Figure 9



Figure 10

f. 3<sup>rd</sup> expander exercise (dynamic): stand with the feet fairly wide apart, right leg straight with foot parallel, the left leg is bent in the knee to an angle of approx 90°; place the left elbow on the left knee; one end of the expander is very securely (!) hooked underneath the right foot, the other end is held by the right hand; pull the expander across your chest towards the left shoulder and relax again. When doing this you should be looking towards your left shoulder to reduce risk of injury should the expander come loose from under the foot. Should be also done on both sides. See figures 11 & 12.



Figure 11



Figure 12

g. 4<sup>th</sup> expander exercise (dynamic): upright stance; arms are stretched out in front of you, shoulder level, holding on to the expander; pull equally to the sides until the strings touch your chest; come back to starting position, keep arms stretched throughout. See figures 13, 14 & 15.



Figure 13



Figure 14



Figure 15

h. 5<sup>th</sup> expander exercise (dynamic): this exercise is particularly helpful for compound archers. Have an upright stance; one handle of the expander securely fixed with the foot of the bow arm side; the other handle shall be lifted up to the horizontal with the bow arm stretched out (abduction). Make sure that the bow hand takes approximately the same position as if holding a bow, as otherwise muscles which are not used for holding the bow will be strengthened. See figures 16 & 17.



Figure 16



Figure 17

## Literature and origin of the illustrations

Debrunner, A. M., Orthopädie, Die Störungen des Bewegungsapparates in Klinik und Praxis, (1988), ISBN 3-456-81665-0

Hess, H., Montag, H.-J., Sportverletzungen; Hrsg. Luitpold-Werk, München, 5. Aufl.

Sobotta, Atlas der Anatomie des Menschen (CD-ROM-Version 1.5), Hrsg. Urban&Schwarzenberg (ISBN 3-541-17492-7)

Waldeyer, A., Mayet, A., Anatomie des Menschen, (1980), Hrsg. Walter de Gruyter, (ISBN 3-11-005733-6)

Wilmot K., personal informations 5/2005

Elizabeth Andrews, "Muskel Coaching", "Angewandte Kinesiologie in Sport und Therapie", VAK Verlag für Angewandte Kinesiologie GmbH, Freiburg im Breisgau, ISBN: 3-924077-36-3

We used illustrations made by us and the following ones:

**Page 3, left column:** Tensed and relaxed muscle on joint, from Elizabeth Andrews, "Muskel Coaching" (Angewandte Kinesiologie)

**Page 3, right column, top:** Chest cavity seen from top, from Sobotta-CD "Anatomie des Menschen" (Urban&Schwarzenberg)

**Page 3, right column, bottom:** Shoulder blades, from Waldeyer "Anatomie des Menschen" (de Gruyter)

**Page 4, left column:** Deltoid muscle, from Sobotta-CD

**Page 4, right column, top:** Supra-/infraspinatus, from Hess "Sportverletzungen"

**Page 4, right column, bottom:** Anterior serratus, from Hess "Sportverletzungen"

**Page 5, right column, top:** Trapezius/latissimus dorsi, from Sobotta-CD

**Page 5, right column, bottom:** Cross section through chest cavity, from Sobotta-CD

**Page 6, left column:** Chest cavity, from Sobotta-CD plus drawings from Josef PREISSER

**Page 7, right column:** Finger, from Sobotta-CD

**Page 8, left column:** x-rays from Josef PREISSER

**Page 8, right column:** Combination made by Josef PREISSER from two pictures (upper and lower leg) from the Sobotta-CD

**Page 9, left column:** Angles with an upright standing person, from Debrunner "Orthopädie"

**Page 9, right column:** Deep back muscles, from Sobotta-CD



FITA  
Coach's  
Manual

**BAREBOW**

Module

Intermediate  
Level



# FITA Coaching Manual

## Intermediate Level

### Module

## BAREBOW

### Contents

<b>1. Introduction</b>	3
<b>2. Equipment</b>	3
2.1 Bow riser (handle)	3
2.2 Grip	3
2.3 Limbs	3
2.4 String	4
2.5 Button (Plunger)	4
2.6 Arrow Rest	4
2.7 Nock points and arrow nocks	4
2.8 Arrows	5
2.9 Tab	5
<b>3. Shooting Technique and Tuning</b>	6
3.1 Starting barebow shooting	6
3.2 Stance and body alignment	7
3.3 Drawing	7
3.4 Aiming methods	7
3.5 Anchor point or 'facial mark'	8
3.6 Gap Shooting	8
3.7 Face Walking	8
3.8 String Walking	8
3.9 Combination of Face and String Walking	9
3.10 String walking with Gap Shooting	10
3.11 Release	10
3.12 Follow through	11
3.13 Analyzing	11
3.14 Sighting corrections	11
3.15 Tuning	11
<b>4. Conclusion</b>	12
<b>5. Glossary</b>	12

### 1. Introduction:

Barebow archery and recurve archery are much alike, therefore in this barebow module we concentrate on those elements of archery that are typical for barebow and refer for the common elements to the recurve module.

The barebow is defined for competition by FITA rules. (FITA Constitution and Rules, book 4, Chapter 9.3). It can be described as a bow that is shot without any extraneous equipment such as sight, sight marks on the bow, draw check indicators etc. Archers who want to shoot a barebow must realize that barebow is mainly shot in the FITA disciplines Field, 3D, 3DI and that barebow is not an Olympic discipline. There are indoor and outdoor competitions for barebow.

Shooting a barebow is a good start for novices in the sport of archery. Beginners will without any instruction, most probably draw the bow and aim along the arrow, which is acceptable in the beginning of their learning. After a while they will notice that there is more than just drawing, aiming and release, especially when they shoot at different distances. In different parts of the world shooting traditional bows, with aiming over the arrow, is part of the culture.

Barebow archers develop a good feeling for their bow and can later switch to a recurve or a compound bow if they want to. Shooting a barebow is more and more accepted as a learning process for beginners. In some countries, for example Sweden, beginners in archery shoot a few months with the barebow, to learn every aspect of shooting, with a feeling for the bow. After the barebow introduction they make their choice for any discipline they wish to pursue.

Instinctive shooting is a special method for using a barebow. It is achieved by focusing on the target and releasing the arrow without any conscious attempt to calculate the distance to the target; the shot is executed with a minimum of conscious visual references, such as locating the arrow point at a specific place of the target face pending the shooting distance. This form of archery can be quite accurate, but takes time to master. The concentration required for this form of archery is not conducive to the shooting of the number of arrows shot in major tournaments. Barebow archers rarely use Instinctive shooting in competition.

### 2. Equipment

According to FITA rules the un-braced barebow has to fit through a ring of 12.2 cm diameter. Stabilizers are al-



lowed, but when mounted on the bow must pass the ring test.

### 2.1 Bow riser (handle)

A riser of the so called 'shoot-through' type is not allowed. Metal or carbon recurve risers are allowed for barebow, any colour is permitted, even camouflage. It is recommended that the sight window is squared and high enough to support 'gap shooting'.



It is not allowed to have marks of any kind that may assist with sighting, in the sight window. The configuration of the cut-out of the window as seen by the archer at full draw should not show a 'protrusion' that can be used as a sighting aid.

Additional mass may be added to the riser to stabilize the bow. Some risers are manufactured with fixing points in the lower section to enable the attachment of weights. The same result can be achieved if mass is added directly to the riser if the bow does not have such fixing points. Torque Flight Compensators may be mounted directly to the lower part of the riser.

To determine the right balance of a barebow, so that after the shot the upper bow limb does not move towards the archer.

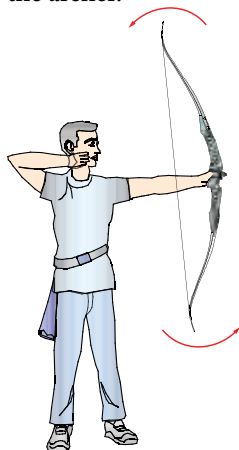

The initial rotation of an un-stabilised bow is the top limb rotates toward the archer.

It is advised that the archer applies, with tape, some lead (as used in fishing) on the lower part on the back of the bow handle at the designated place. Now shoot some arrows at different distances and watch the performance of the bow. By adding or decreasing the weight of lead the archer can determine the extra mass that needs to be put in place to stabilize the bow; but when mounted the un-braced bow must be able to pass through a 12.2 cm ring.

### 2.2 Grip

Take care that the bow grip has no contact beyond the life-line of the archer's hand (no contact at the side of the little finger). There is generally no sliding of the grip to either side; the hand pushes towards the pressure point, the bow should leave the palm of the hand straight forward. Leave it up to the archer's feeling of comfort whether they choose a high, a low or a medium grip. You can resize the grip or even make a new (wooden) one.

Cover the bow grip with Vaseline, have the archer shoot and check to see if their hand is sliding sideward. If that happens, add a layer of material to the corresponding place or scrape away on the opposite side. It is normal that the archer's hand moves towards the throat of the bow.

If we put extra material to the grip, thus making it more suitable to our way of gripping, we are in danger that slight inconsistencies in positioning the wrist joint will change the groupings.

### 2.3 Limbs

It is not allowed to have marks that could be of use in aiming, on the front side (inside) of the limbs. Barebow limbs should be 'stiff', to maximize side stability, so that the bow will not dance around on release. The following figure gives you an idea of the differences in limbs.

Material	Speed of Limb	Draw Feeling
Wood	Very slow	Very weak
Wood/Fibreglass	Slow	Weak
Wood/Carbon	Fast	Weak to hard
Wood/Ceramic	Fast	Weak to hard
Wood/Carbon/ Ceramic	Very fast	Hard

Note that barebow archers shoot up to 50 metres, uphill and downhill.

#### 2.4 String

All kinds of string material and colours are allowed. The centre serving should not have markings for aiming. The heavier the string (the more strands) or the heavier the centre serving (double serving), the slower the string. The top of the centre serving may not exceed eye height; otherwise it could be construed as being used as a measuring aid.

#### 2.5 Button (Plunger)

Any kind of adjustable pressure button is allowed as long as the pressure point is not placed any further back than 2 cm (inside) from the throat of the handle (pressure point). The pressure button is set up exactly the same as for a “freestyle recurve bow”.

#### 2.6 Arrow Rest

Use a strong arrow rest. An arrow rest needs to be reliable and sturdy for barebow archery. Most standard flip rests are robust enough to withstand the pressure the arrow puts on the rest at short distances when string walking. At longer distances (like 50 metres) there is little influence of the arrow rest on the arrow flight. The draw point is close to the arrow; the arrow leaves the string close to a straight line and will have sufficient ‘clearance’ while passing the arrow rest.

At shorter distances (like 30 metres) the archer’s fingers are placed low on the string, away from the arrow, which will create downward pressure of the arrow on the arrow rest. On release the arrow may ‘jump’ from the rest. A thick support arm (more than 1.5 mm diameter) causes the arrow to ‘jump’ even higher.



Bad clearance causes bad grouping. With a long support arm of the arrow rest, there is chance that the fletching (or even the nock) makes contact with the arrow rest.

Hence, the arrow rest support arm position is critical to achieve good clearance.

Nock an arrow on the string and lay it on the arrow rest. Shorten or adjust the arrow rest support arm, so that the end of the wire is not visible outside of the arrow shaft when observed from an overhead view.

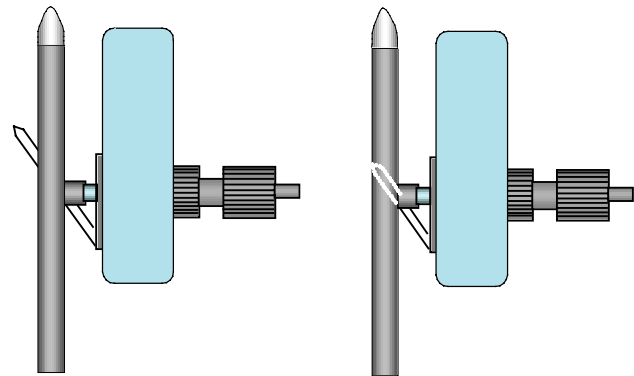

Not Correct

Correct

#### 2.7 Nocking points and arrow nocks

All types of nocking points are allowed – Some commercially available nock locators have the advantage of consistent thickness, but they can tend to break and are not suitable to fit thicker strings. When using the nocking points/arrow nocks combination, the angle between the string and the arrow doesn’t play a role, but the arrow nocks of this arrangement are easily damaged by hits of other arrows on the target. Take care to have an adequate spare supply; special nocks may not be readily available at all archery outlets.

When the arrow is shot from between the index and second finger (Mediterranean release), the arrow is more or less perpendicular to the string. When shooting with three fingers under the arrow, the arrow takes up a sharp angle with the upper part of the string. We can use two nocking points to avoid the arrow nock sliding down the string. Two nocking points on the string should be mounted far enough apart to avoid pinching the arrow between the nocking points.

As a starting position have the top of the bottom nocking point approximately 5 – 6 millimetres above square.

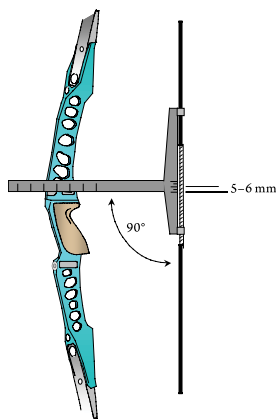

A self-made nock point is a good and reliable alternative. Whichever type of nocking point being used, it is important for consistency from string to string, that the nocking point is always positioned at the same place on the string.

Shown in this picture is a suggested way of tying in a nocking point.

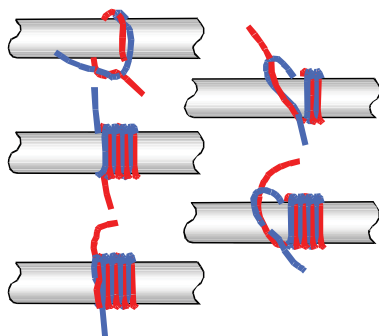

The best way the nock point can be checked for barebow is with the bare-shaft test. The theory behind bare-shaft tuning is that a bare shaft will continue to fly in the direction it was launched from the bow. Shoot at least three fletched arrows and two un-fletched arrows at targets at 15 and 30 metres. The 15 metres will cover the short distances whereas the 30 meters is just over half of the longest distance for the barebow discipline Field Archery. It is important that the coach watches that the archer shoots identical shots, especially with the same finger position on string and facial location.

If the un-fletched shafts impact above the fletched shafts, the nock point is too low, if the un-fletched shafts impact below the fletched shafts, the nock point is too high. It is sometimes desirable to have the bare shaft impact just slightly below the fletched shafts to ensure that the nock point is not too low, as this could cause clearance problems. It could also be considered in having the bare shaft impact slightly to the left of the fletched group to compensate for the string reflex.

## 2.8 Arrows

Archers can shoot any kind of arrows with the barebow but they have to be aware that they should be able to reach 50 metres under comfortable sighting conditions. With this in mind an archer who intends to shoot aluminium arrows should have a bow with a draw weight of around 45 lbs. With medium weight aluminium/carbon arrows the draw weight should be around 42 lbs. With light weight aluminium/carbon arrows a bow of 35 lbs should be sufficient to reach the required distance with ease. These suggestions will depend on the archers draw length – with the longer the draw length the power stroke will be longer; this will impart greater power into the launch of the arrow.

See the selection chart from your manufacturer, or refer to an Arrow Flight Simulator program commercially available for use on personal computers.

It is recommended for beginners to start with arrows, which are longer than the measured draw length, because after a few months of intense practice the draw length could increase up to one inch or more, due to the strengthened muscles of the shoulder girdle and better use of the chest cavity through good breathing techniques. Accordingly, the arrows chosen should be one or even two spine values stiffer than recommended in preparation for the increase in draw length.

## 2.9 Tab

The purpose of a tab is to protect the fingers. A smooth tab with a uniform surface reduces the friction with the string and affects a clean release. The smoother the tab, the weaker the arrow reacts. Bad surface texture of a tab can result in differences in dynamic spine. A little talcum powder on the tab ensures a smooth surface, and extends the life of the tab.

In contrast to the tab used in “freestyle recurve archery”, the face of a tab for barebow archery has no cut-out between the forefinger and second finger.



The barebow tabs are available in small, medium and large sizes for either right or left hand shooters. The face should be just long enough to cover the drawing fingers

when the fingers are curled around the string. Any surplus may be cut off.



A tab with an anchor shelf is only suitable if the facial reference is located under the jawbone. It is preferable for a barebow archer to use a tab without an anchor shelf, to obtain a firm and repeatable facial reference. Some tabs are adjustable and allow the location of the facial reference to be varied. These tabs permit the archer to have a lower anchor point, if required maybe under the cheekbone.

Stitches of approximately 3 mm assist in finger placement on the string when string walking is used. An adjustment of the finger placing on the string of 3 mm equates to making a sight adjustment for approximately 5 metres depending on the draw weight of the bow, the archer's draw length, the weight of the arrow and the archer's technique. Practice will confirm these parameters to the individual archer. Positioning of the fingers on the string for string walking can be accurately determined by using a tab; a shooting glove gives less accurate measurement.

### 3. Shooting Technique And Tuning

#### 3.1 Starting barebow shooting:

In the FITA Coaches Manual, Entry Level the beginning archer has been taught the basic elements of shooting, we now go on with the aspects that concerns shooting with the barebow. In barebow, the recommended technique to instruct beginners is 'point of aim' (aiming over the arrow point), which basically the barebow style.

Beginning archers have to learn and stabilize the shooting routine and find out the fundamentals of barebow shooting. It is recommended for beginning archers to start at a short distance, say 15 metres (depending on age and draw weight sometimes 5 to 8 metres will suffice). This will allow the archer to shoot with both eyes open or one eye closed and to have one constant string position and anchor point, so that they can concentrate on getting the smallest possible arrow groups.

Draw and anchoring are vital parts of the routine and must be consistent before going to other distances. It's a good idea for beginners in order to find the correct anchor point to use a kisser button which has to be adjusted by the coach, thus the archer can correct himself quite easily.

The point of aim can vary with the distance to be shot. The beginning barebow archer should not worry about any aiming procedure until they feel comfortable handling and performing the basic fundamentals of the barebow like stance, drawing, anchor point, release and follow-through. When a general understanding of fundamentals of the barebow is acquired, the archer should concentrate on aiming and getting small groups of arrows at one constant close distance (5-8 metres or 15 meters) on a large Gold (cut from a 122 cm target face) and thereafter at various distances.

When the archer's head is in the correct position, the archer tends to 'look through' the bow string. The setting and checking of the bowstring alignment becomes automatic with experience and most of the concentration for aiming purposes must be directed to the arrow point. Before the archer starts focusing on the gold, and whilst drawing the string towards their anchor point, the archer should align the bow string and bring the point of the arrow in their focus line on the gold.

Most archers prefer on the longer distances, to set the arrow point just underneath the centre with the top edge of the arrow point just touching the lower border of the gold, so that the arrow point will not cover the whole gold. On the short distances they prefer to set the arrow point on the gold. 'On the job' training is the best teacher.

New archers shooting barebow have the tendency to release the arrow as soon as they are in the gold without properly aiming ('snap shooters'). Let them hold for one to two seconds as soon as they are 'in the gold' for proper aiming.

After the archer has acquired experience in aiming with the barebow the archer can practice with the correct target faces at the correct distances. It is also recommended, as barebow is mostly shot in the Field or 3D discipline, to practice with 3D animals on their specific distances.

There is a subjective, kinaesthetic feeling, the experienced barebow archer attains when the arrow point is placed on the gold during the aiming process prior to release. Progress is made only through intense attention, and nothing must be allowed to interfere with the intensity when the arrow point is placed in the gold.

As soon as a good basic form has been mastered the concentration switches over to the aiming process and the degree of scoring success one has whilst shooting barebow. One must be aware of what effect on the accuracy of the arrows the weather conditions have at different velocities and directions. (Of course, different weather conditions have their specific effect on the arrow flight). Aiming adjustments have to be made and the experience in different weather conditions becomes the best teacher.

Through extensive practice over a long period of time, the archer increases skills related to barebow shooting and kinaesthetic awareness, to correct responses to different conditions, e.g. changing wind speed and directions. These factors and others, enable the skilled archer to adjust rapidly as they look over the arrow point towards the intended target.

### 3.2 *Stance and body alignment:*

It is desirable that the archer's stance is consistent, but as barebow is mostly shot in Field or 3D competitions, the terrain, which can change from post to post, dictates the stance. This regards especially the lower body; the upper body can keep consistency in shooting under most terrain circumstances.

The base for a good body alignment is a well-balanced stance. Novices should at first build up a consistent shooting form on an even shooting range. They should think of a tall straight tree reaching for the sky, with the roots deep in the ground. In non-extreme field conditions the frontal plane of the body is in the shooting plane, shoulders, hips and feet in line, chin and nose pointing towards the target. Maintain your preset posture while raising and drawing the bow.

Barebow archers have to practice all kinds of stances and learn how to balance on uneven terrain, where the weight of their body often rests mainly on one leg only. (With uphill and downhill shots the lower leg is carrying the main load). Very steep downhill shots sometimes force the archer to kneel on their rear knee. The same applies, the other way round, to very steep uphill shots, where the archer may kneel on the knee pointing towards the target (front leg).

Whereas the recommendation in target archery is that the body weight is evenly distributed over both feet, the recommendation for barebow archery is that the distribution of body weight is approximately 60% on the front leg (the one closest to target) and 40% on the rear leg. In

the end the archer should feel comfortable and balanced according to the different situations.

### 3.3 *Drawing*

Drawing is pulling the string to the anchor point in one smooth movement. The most important aspect in barebow shooting is the consistency of the draw length. This is difficult, because there is no draw length indicator such as a clicker on the recurve bow or the valley/wall on the compound bow.

To control the consistency of the draw length of the archer for practice purposes, may attach a white tape on the inside of the bow window with a marking on the tape. While the archer is at full draw mark the arrow in line with the marking on the tape, or make a mark on the arrow in line with the front/back end of the sight window.

To come to the correct draw length for barebow shooting it is advisable to start the draw a little higher than shoulder height. The bow shoulder will be pushed towards the butt as far as possible, thus is not contracted or allowed to collapse towards the spine, whereas the shoulder blade of the string side should move toward the spine as the bow is drawn.

### 3.4 *Aiming methods*

There are three methods of aiming in barebow shooting. A combination of these methods can be adapted to suit the individual archer.

Gap shooting

Face walking

String walking

Combinations:

Face and string walking

String walking with gap shooting

All the above mentioned methods use the tip (point) of the arrow for height sighting and the string/bow window edge for windage sighting. Below are two pictures showing the most common sighting pictures. Development of a method of sighting for a barebow archer is a long process.





### 3.5 Anchor point or 'facial mark'

The anchor point depends on how the archer wants to aim. Preference for a particular anchor point usually is dictated by the facial contours and the type of shooting. It is recommended that novices in barebow start with string walking (which is the most accepted style) and a fixed point of anchor on the face, preferably the cheek bone, just underneath the eye. Anchor points/facial marks are usually described as being high or low on the face. An anchor point/facial mark on or under the mandible or jaw bone is termed low. An anchor point/facial mark on or underneath the cheekbone is called high. Both types of anchor points/facial marks can be used effectively for any kind of barebow shooting.

### 3.6 Gap Shooting

Gap shooting involves maintaining the same finger setting on the string and the same facial reference at different distances while sighting with the tip of the arrow on different points above or below the target centre. The correct gap (point of aim outside the target centre) has to be determined for various distances and under varying shooting conditions, which is time consuming and can be a frustrating exercise. The point of aim is usually below the target centre at shorter distances and above the target centre at the longer distances.

### 3.7 Face Walking

The anchor point (facial mark) changes ('walks') on the archer's face depending on the distance of the target. The photographs below show the variation in contact between the hand and face at various distances. The facial reference is closer to the eye for the shorter distances. Photos of LINHART Reingild (AUT), the 2002 World Champion Women Barebow in Canberra (Australia).



The advantage of this method is that the tune of the bow does not alter with distance because the draw fingers are in the same position on the string for all distances. The disadvantage is that left and right variations occur due to the hand position following the anatomical shape of the face, that is, when the hand is located on the cheekbone it is further out with respect to the eye than when located at the corner of the mouth.

Different facial references are not as reliable as a fixed anchor point and finding the exact reference point for each distance can be difficult to achieve making this method of aiming unreliable. Face walking is mostly used with the long bow.

### 3.8 String Walking

This method of shooting barebow is most common in field archery. String walking means that the archer's fingers change their position on the string when changing the distance, while the anchor point (reference point) is constant. The closer to the target, the lower the archer's fingers are located on the string, (the arrow nock is closer to the eye). The further away from the target, the closer the fingers are to the nocking point on the string, (the arrow nock is lower with respect to the eye).

The archer's aim is over the point of the arrow. The point of the arrow is sighted on the centre of the target, whenever possible, while the position of the arrow nock is varied by altering the finger position up or down the string for the varying target distances, in other words walking the string means that the arrow point is constant on the target centre while the finger position on the string determines the elevation for the distance to be shot.

If thicker thread (0.5 mm) for the centre serving is applied, then string walking can be done by counting the threads, otherwise we use the tab. Start with the top edge of the tab touching the nock, then move the thumbnail

down to the point on the string opposite the place on the tab which the archer has determined for the distance to be shot; keep the thumb nail on that point and move the tab down the string so that the top edge aligns with the thumb nail. Then place the draw fingers on the string in the usual way. Some barebow archers have a longer and straighter thumbnail for string walking.

With string walking the archer can shoot different distances with reliable aiming and with a lot of checkpoints. The standard grip on the string for string walking is with three fingers under the nock. The facial reference point is the tip of the forefinger touching the corner of the mouth while having the index finger located firmly underneath the cheekbone.

The following pictures demonstrate what is described above for a shot at a short distance of approximately 10 metres.

The following pictures show the fingers placement for the longer distance of 50 metres. Marking the distance and setting the finger at the right location, with the use of the tab and thumb.

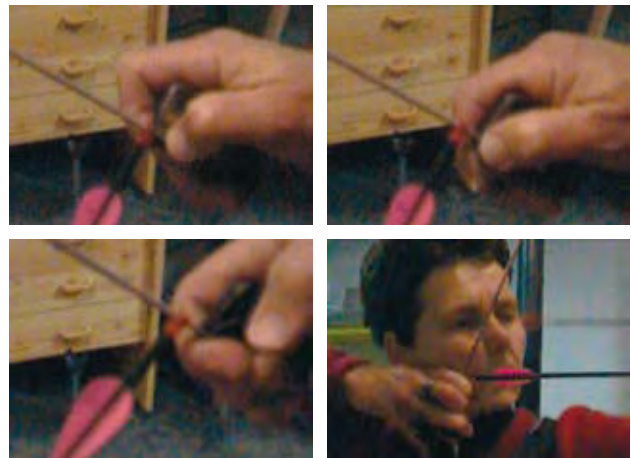

Notice the distance between the nock and the eye.

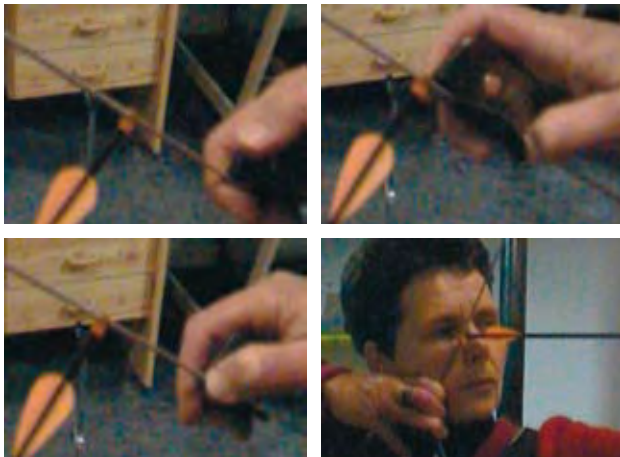

Notice the distance between the nock and the eye.

The following series of pictures shows the finger placement at the middle distance of 30 metres. Marking the distance with the thumb and setting the fingers at the right location, with the use of the tab and thumb.

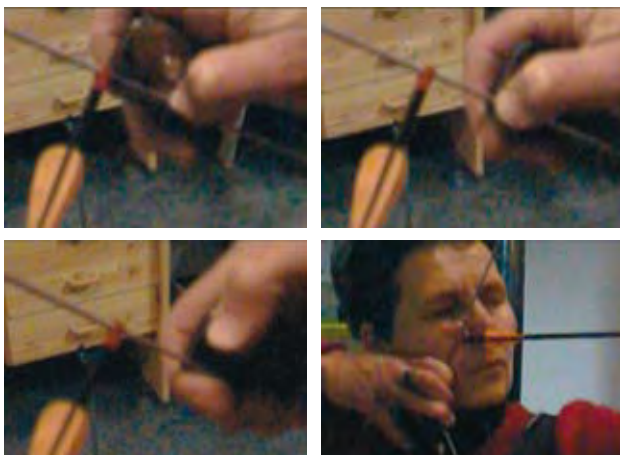

Notice the distance between the nock and the eye.

### 3.9 Combination of Face and String Walking

In this method of aiming the archer uses two or three anchor points and combines these with different locations of the fingers on the string. This method is useful for Long Bow archers. These bows expel the arrow at a much lower speed so that the archer needs more anchor points to achieve the correct elevation.

#### 3.10 String walking with Gap Shooting

This method of aiming becomes more and more popular and is simpler than string walking. The archer has a table that maps each size of target face (20cm, 40cm, 60cm and 80cm) to a location on the string. This location corresponds with more elevation than is needed on the longest distance with the particular target face. We anticipate on the relatively straight flight of the arrow on these distances.

Example; measurements when using a 20 cm target face:

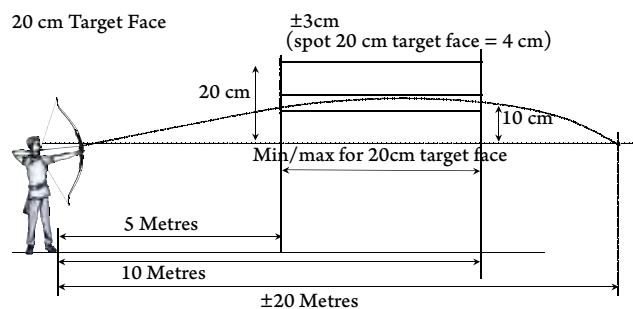

Example; measurements when using a 40 cm target face:

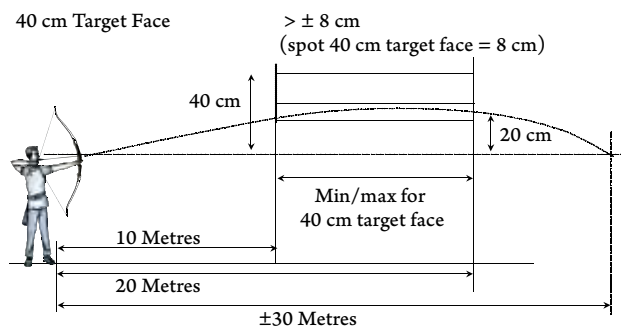

Example; measurements when using a 60 cm target face:

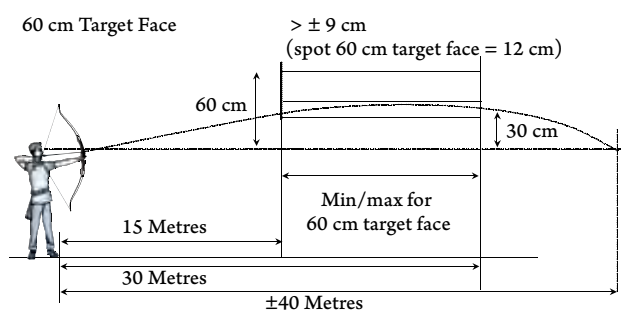

Example; measurements when using a 80 cm target face:

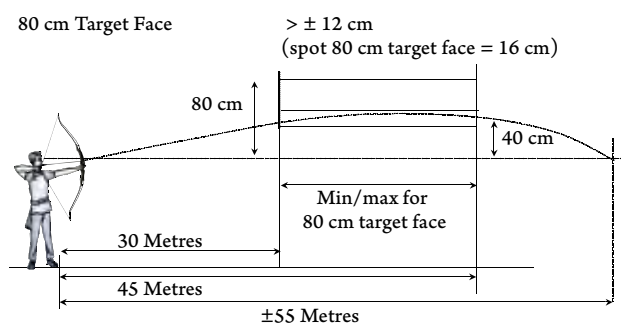

*The four above diagrams are from Jan Koonings*

It is important for the archer to know where their personal reference points for different distances are; these must be sorted out in practice by intense shooting. For example: At a 40 cm target face the archer places the draw fingers on the string as if the distance is 15 metres, shoot the first arrow on the shortest distance, say 10 metres. Aim into the middle of the target face, the arrows will hit the target face at the top in the 1 or 2 ring. The second arrow the archer shoots with the finger on the same location on the string (15 metre mark) on the longest distance of the 40 cm target face and the arrow will hit in the lower part of the target face (20 m). Now find out how much the archer has to adjust to come in the centre. If the archer got a high (1 or 2) he would then have to aim into the 1 or 2 ring low in order to hit the centre of the target face.

With this system the archers have a constant anchor point. They only use four markings on their string. This method is a lot easier than string walking, as the archer does not have to measure the distances. The archers has less points to keep in mind and therefore they can concentrate more on their technical part of shooting, such as keeping up a consistent draw length, aiming and release, which are highly important when shooting barebow.

### 3.11 Release

The release of the arrow is calculated to coincide with the visual perception of the gap being closed by the arrow point coming into view of the target whereas the bow will be held motionless for a second when the gap has been closed in order to implement an efficient release. It coincides also with the kinaesthetic perception of a good and stable form.

Releasing the arrow is one of the most important fundamentals of shooting. The key elements are relaxation and concentration. Both of these elements must be under complete control. Releasing the arrow is not the result of forceful finger extension; it is an act of relaxing tensed fingers and muscular interaction with the bow hand. (Push and Pull interaction).

The bowstring literally pushes the fingers out of its way if the fingers have been relaxed sufficiently. It is very important that the archer understands that the draw arm moves through its range of motion without interruption (Dynamic release). Some barebow archers have the tendency to have a static release, holding their string hand against their face and forcing the fingers to extend causing the arrow to hit anywhere on the target and in due time it can also cause muscular injuries.

### Training the release (technique suggestions):

- Simulation of string hand relaxation. With the string fingers, the archer grasps middle bow finger that is pointed down. Have a flat string wrist and hand (the wrist joint should be straight); the archer's string hand should be 'twistable'. Both elbows should be slightly higher than shoulder level. Let the archer simulate a release while watching their string hand. At the end of the simulation, be sure that the archers hand is relaxed, the wrist should be bent down and the fingers quite relaxed.
- To get a good 'mental picture' of string fingers relaxation try following.
- Take a bucket with a thin iron handle and fill it with sand. Now let the archer hold the bucket at the side

of the body, they then relax the fingers until it drops/ glides away from the fingers. This 'mental picture' is the same as releasing the string. The archer should try to remember this while practicing a perfect release.

### 3.12 Follow through

Follow through is essential for consistent performance and minute accuracy. The arrow hits the target before the archer relaxes. The follow-through should be always the same, no matter if the archer shoots at a long or short distance, thus getting the sound of the arrow impact after different time spans.

### 3.13 Analyzing

After every shot the archer should analyze their routine and the outcome (score). Detected inaccuracies and possible reasons:

#### *Arrow hitting the target face in the upper region:*

- Throwing the bow upwards on release
- Finger position on the string too high: Place fingers lower.
- Make sure the archer is not pushing against the bow grip with the entire hand or palm of the hand.
- Make sure the archer has the right anchor point/facial mark.
- The archer should take time to aim, so that they release the string when the arrow is pointing to the proper aiming point.

#### *Arrow hitting the target face in the lower region:*

- Keep the wrist stabilized and extended at release so no extra motion occurs in that joint.
- Finger position on the string too low: Place fingers higher.
- Make sure the archer has the right anchor point/facial mark.
- Make sure the archer has the right draw length while releasing and not creeping forward at full draw.
- The archer should take time to aim so that the release will coincide with the arrow point intersecting the desired aiming point.
- Maintain the correct bow arm position without lowering it until the arrow hits target.

#### *Arrow hitting the target face on the right:*

- Check the archer's stance: align the body with the target, it may be being rotated to the right.

- Check the archer's head position: align the head upwards, the archer may be "leaning: into the string.
- Adjust the archer's grip to eliminate any possibility of a clockwise torque of the bow upon release.
- The left handed archer may also push too hard with the bow arm which causes high- right hits.
- Check to see if the archer's string alignment has not moved to the left.
- The archer should concentrate on the relaxation of finger joints (the flexor muscle) during the release.
- Archer should concentrate on extension of the bow hand in a straight line toward the target.
- Check the archer's anchoring, it may be inconsistent as they may be pushing it too hard into the face or just brushing it.

#### *Arrow hitting the target face on the left:*

- Check the archer's stance: align their body with the target instead of rotating it to the left.
- Check the archer's head position: align the head upwards as archer may be 'leaning it backwards'.
- Check the archer's bow grip as they may be grabbing the bow, use a bow sling.
- Check the archer's position of the elbow on the bow arm, the elbow should be fully extended at all times as archer may be flinching or flexing the elbow at release. (The same applies to the bow shoulder which should be pushed out at its maximum).
- Check the archer's anchoring/facial marking, as archer might be pushing it too hard into the face or just brushing it.
- Any extra action such as plucking the string will cause a group error to the left.
- Archer should concentrate on extension of the bow hand in a straight line backwards.

### 3.14 Sighting corrections

On the recurve bow the bow sight is always moved to the arrow grouping area. When shooting barebow it is just the opposite:

- Arrow grouping too high, the archer must alter their finger placing to LOWER on the string.
- Arrow grouping too low, the archer must alter their finger position to HIGHER on the string.

### 3.15 Tuning

Archers have to tune their bow from time to time. Bow and arrows are bought independently from each other, the

bow to a recommended bow length and draw weight and the arrows to a rough estimate from an arrow selection chart. When first acquired, the equipment is not suitable for shooting until basic tuning is carried out. Tuning is required by all types of bows to ensure that the equipment fits the archer and is capable of achieving good groups.

Barebow archers who use only gap shooting and/or face walking (with only one draw point on the string), tune their bow just the same as recurve archers; they have only one draw point on the string. The (fixed) draw point on the string is one of the parameters for tuning. In string walking we use different draw points on the string, for tuning we use a middling draw point.

Most bows are reasonably tolerant to small deviations of the normal static tiller. The static tiller is the distance from the upper limb base (or limb pocket) to the string minus the distance from the lower limb base (or limb pocket) to the string. Check the manufacturers recommended measurements for setting the static tiller on the particular bow being used. Keep the static tiller as small as possible on your barebow for good results. Tiller adjustment is carried out as for recurve bows.

The force generated at the nock of the arrow during the release and arrow acceleration varies with different finger positions on the string. The nocking point height for string walking is a compromise that will give acceptable arrow flight at both short and long distances. The nocking point is usually set for correct arrow flight at a mid-way distance. Start with the top of the bottom nocking point 5 to 6 mm above square. Shoot some arrows and go through the tuning method found in the Recurve Bow section of this manual.

#### **4. Conclusion**

Coaching of all forms of barebow archery should concentrate on correct style with emphasis on the facial refer-

ence and string alignment. The basic upright posture as introduced in the FITA Entry Level Coaching Manual should be encouraged. Variations to this form is inevitable if used for Field Archery due to the uneven feet position in the field but a good sound basic form should be developed. The facial reference is the rear sight and as such must be consistent. Depending on the archer's style their facial reference will be dictated by the aiming method used. Both the Straight Line and the Triangle method of aiming are comprehensively covered in the Entry Level Coaching Manual.

#### **5. Glossary**

##### ***Draw point***

Point on the string where the fingers pull the bow

##### ***Face walking***

Method of aiming on the target centre over the arrow with fixed draw point, where the facial mark is chosen according to the distance to shoot

##### ***Gap shooting***

Method of aiming over the arrow with fixed draw point and fixed facial mark, where the point of aiming is chosen according to the estimated distance to shoot, above or under the target centre.

##### ***Post***

Place of shooting line in field archery.

##### ***String walking***

A method of aiming on the target centre looking over the arrow with fixed facial mark, where the draw point is chosen according to the distance to shoot.





FITA  
Coach's  
Manual

**CLOUT ARCHERY**

Module

Intermediate  
Level



# FITA Coaching Manual

## Intermediate Level

### Module

## CLOUT ARCHERY

### Contents

<b>The Clout Round – Description</b> _____	2
<i>Some Rules</i> _____	3
<i>Aiming</i> _____	3
<b>Shooting Form</b> _____	4
<b>Shooting Techniques</b> _____	5
<b>Strategies</b> _____	5
<b>Equipment</b> _____	6
<b>The String</b> _____	6

### The Clout Round

The Clout Round is a long distance shoot at a target laid out on the ground with a central flag, called the clout, and is mounted on a short flag pole.



*Setup of a local clout tournament with the flags at the three official FITA distances.*

There are two divisions recognised in the Clout Round, these are the Recurve Division and the Compound Division.

Clout shooting is a very old archery discipline derived from the desire to shoot at targets (opposing enemy) at extreme distances. Some older Societies shoot two-ways (targets at each end of the range, the archers shoot their arrows—and collect and score them then shoot back to

where they have just shot from). The FITA rules are for one-way shooting only.

A Round consists of shooting 36 arrows from one fixed shooting line and in one direction only. Six sighting arrows being shot in two ends of three arrows are permitted preceding the commencement of the competition. These arrows shall be shot under the control of a Director of Shooting and shall not be scored.

During the competition the object is to group your arrows as close to the clout (flag) as possible and achieve a score accordingly. The FITA distances are:

- 165 metres for Gentlemen shooting the Recurve Bow.
- 125 metres for Ladies shooting the Recurve Bow.
- 185 metres for gentlemen shooting the Compound Bow.
- 165 metres for Ladies shooting the Compound Bow.



The clout target shall be 15 metres in diameter with the clout (flag) positioned in the centre. This will be divided into 5 concentric zones each 1.5 metres in width, the scoring is 5, 4, 3, 2, 1, from the centre zone outwards, if an arrow lands in a line that divides two scoring zones the arrow will score the higher of the two zones. The flag shall not measure more than 80cm in length and 30cm in width and should be no more than 50cm from the ground.



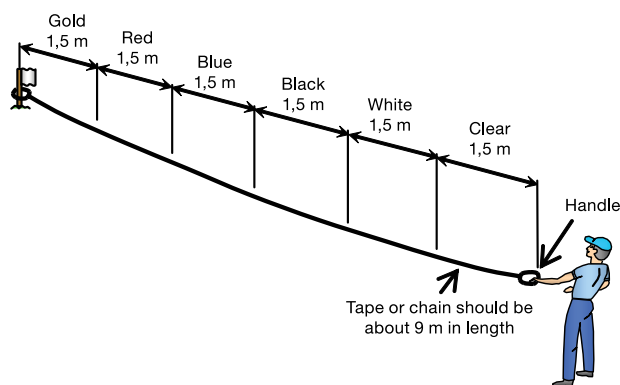

Five persons are allocated one zone of the target and they take up their position along the tape. The person holding the end of the tape slowly walks round the flag (clout) keeping the tape tight at all times. The people allocated to the individual scoring zones walk round following the tape collecting the arrows that have fallen within their zone. When a complete 360 degree circuit has been walked, and all the arrows have been pulled from the ground, the tape is laid flat on the ground (still attached to the clout flag) the five persons then lay the arrows they have collected on the zone they were allocated. Then each person walks forward in turn to retrieve their arrows, in descending score order and calling out the score as each arrow is retrieved.



### Some rules

The competition organiser may choose whether the competition will be shot in ends of three arrows or ends of six arrows. If an end of three arrows is selected then the archers will have a maximum of 2 minutes to shoot their three arrows. If an end of six arrows is selected then the archers will have a maximum of 4 minutes to shoot their six arrows.

The archers may not raise their bow arm until the signal to commence shooting is given.

If an archer shoots an arrow before or after the allotted time they will forfeit the highest scoring arrow.

### Aiming

To obtain even a modest score it is essential to be sighted in correctly from the first scoring end.

If the system doesn't allow this (apart from luck) one can easily spend two or three ends just getting a group in the right place. As the round is very short all chance of competing or even obtaining a reasonable score can be over before begun.

Because of the elevation of the bow most people cannot see the clout flags to aim at so that they need to pick a spot somewhere in the back or foreground to aim at. While this can be fine once the spot has been determined there is often difficulty, at unfamiliar venues, to find out just where that is. In addition, with a long line, the background can vary significantly from end to end, thus presenting an unfair advantage to those with easily distinguishable spots to aim at, for instance an apartment building with lots of windows as opposed to say a blank concrete wall.

If a standard modern recurve bow as explained in a) & b) above is used. An extender sight bar coming below the bow hand can be used allowing the archer to approximate in the same plane as the clout but this is often to one side of the bow (maybe some part of the stabiliser) or a mark on the lower limb can be used.



*The extender sight bar coming below the bow hand.*



A mark on the lower limb can be seen directly below the hand and can be lined up with the clout unless wind allowance is catered for, in which case aiming left or right may be required. c) & d) can often use a standard sight. A small rubber/elastic band placed on the bottom limb can be used for a sight.



Mark (rubber band) on the lower limb.

A rule of thumb is approximately 1 inch (2.5 cm) of movement could vary the distance of the shot by as much as 5 metres.

**Shooting Form**

Posture is the prime requisite as in target shooting as all errors are magnified by the distance.



Ensure the body is upright before starting the shot.

Many archers bend back at the waist to keep the bow-arm, shoulders and drawing-arm in line to keep an efficient “draw force line” but this can create the spine to curve which may cause some discomfort during the day. For recurve shooters, since the shooting angle is not so great; hence they should be able to bend their waist enough.



By leaning back from the waist to get the elevation for the shot, the spine is bent and may cause pain during the day.

For longbow archers and light Recurve bows, an alternative and less stressful way is to take a slightly wider stance (than for target shooting) and bend the rear leg (string leg) slightly so that the whole body is leaning away from the target (clout). The bow-arm, shoulders and drawing-arm can be kept in line and at a right angle (90 degrees) to the spine whilst keeping the spine straight.



By bending the rear leg, the front thigh and body can be aligned.

A high anchor (reference point) as in Field Archery shooting with the forefinger coming to rest under the cheek bone may be tried as some archers may be more comfortable with this face location. Some may wish to continue having a reference point under the chin. Which ever method is used it must be adhered to minutely as all errors, no matter how small, are magnified by distance.



Using a kisser button allowing the drawing hand to be lower than a normal anchor position.

By using a kisser button in a position that allows the drawing hand to be lower than a normal anchor position to get the required elevation, the body can maintain an upright posture. Also the front sight could be used for aiming at the flag if the kisser button is set in the appropriate position.

A high anchor (reference point) as in Field Archery shooting with the forefinger coming to rest under the cheek bone may be tried as some archers may be more comfortable with this face location. Some may wish to continue having a reference point under the chin. Which ever method is used it must be adhered to minutely as all errors, no matter how small, are magnified by distance.

### Shooting Techniques

Most coaching points apply equally to clout as in target shooting, consisting of posture, minimal head movement, bow-hand movement and follow-through being controlled, a reaction not an action is vital and is of paramount importance. Good groups at the maximum range of the bow indicate superior technique which is highly desirable.

A clean physical follow-through where the string hand goes straight back in a natural reaction is to be desired, rather than a bicep/triceps, dead loose type of release.

The better the release the more consistent the arrow flight will be, and consequently better arrow grouping will be achieved.

Another important point is the bow verticality. For training your archer in keeping their bow vertical, you can affix a level somewhere on the bow. Your recurve archers will have to remove this device for the competitions.

### Strategies

In general it is a big help to ascertain the line the shot and to watch the flight of the arrow. This is done by looking away from the aiming point, immediately after releasing, up to the arrow and observing the flight then correcting the aim for the next shot. This will also help to see if the arrows match the bow or undue “kicks” or poor arrow flight is apparent.

The problem with this method is that the archer ensure a poor follow-through, this is why the coach should take care of the arrow flight, while the archer remains focussed on the aiming point.

To check the length or distance of the shot when shooting two ends of 3 arrows, between ends walk as far to the side as practical and with binoculars seek the distances of your archer’s shafts.

When coaching a Compound archer it is advisable to have them shoot very low to start with as many compound bows are capable of shooting vast distances and may even overshoot the safety area. There is also another problem that compound shooters may encounter, with the extreme power the arrows will have a flat trajectory and may be difficult to find if the grass is not kept quite short. If the ground is also very hard and the trajectory is very low the arrows may not stick into the ground but may “snake into the grass” and be difficult to locate.

Maximum distance is usually obtained by shooting at approximately 43 degrees, although there is liable to be a difference if a strong head or tail wind is blowing.

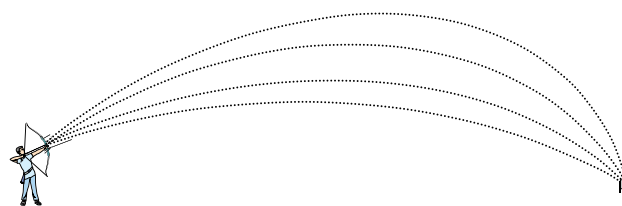

Illustration of various angles and trajectories.



An arrow from a Recurve bow not reaching the clout may have been shot at an angle that is too low; the angle of landing (landing angle–LA) can indicate this. As the arrow descends the parabolic curve will be steep (a high landing angle (LA), maybe as much as 60 degrees. If the arrow angle is 45 degrees or less then further distance will be obtained by shooting higher. Conversely “angle shots” i.e. shots above 45 degrees in a very strong tail wind will not go as far as a shot released at 43 / 44 degrees.

### Equipment

The arrow weight may well have some bearing on a long range group. The heavier shaft could well group better than light weight shafts as the latter could be deviated by a light breeze.

(Especially for Longbow users) Shooting and spectacular results can be obtained with wooden arrows which are “cheded” i.e. the balance point is to the back and sometimes past the centre line of the arrow. Barrelled arrows can use the same principle of keeping the weight low whilst the spine rating is kept at a reasonable figure.



*A “cheded” arrow with a hard wood footing.*

Low profile fletchings keep drag to a minimum whilst providing enough steerage.

Aerodynamically a bullet point (pyle) may give some benefit but it is hard to put a figure on it. Reducing the fletching size is more readily noticeable in the benefit gained. Three fletch is far superior to four fletch if distance is required.

### The string

High density polyethylene such as Dyneema will give about 10% more distance over Polyesters such as Dacron etcetera. Having a low bracing height can give more distance at the expense of smoothness. Reducing the number of strands in the string can also increase the distance of the shot. There might be some jarring/vibration felt although some stabilisation might take care of this.



*A nice shot!*

*(As per FITA rule, the flag pole should be round. A round shape minimizes the number of arrows in the pole).*



FITA  
Coach's  
Manual

**COMPOUND BOW**

Module

Intermediate  
Level



# FITA Coaching Manual

## Intermediate Level

### Module

## COMPOUND BOW

### Contents

<b>1. Diagram</b> _____	3	<b>6. Release</b> _____	12
• <i>Diagram of compound bow</i> _____	3	• <i>Release aid styles and descriptions</i> _____	13
<b>2. The Compound Bow</b> _____	3	<b>7. Form</b> _____	13
• <i>Axle to axle length</i> _____	3	• <i>Level I Manual</i> _____	13
• <i>Riser design</i> _____	3	• <i>Bow arm/hand</i> _____	13
• <i>Draw force curve</i> _____	4	• <i>Facial Marks</i> _____	14
• <i>Eccentrics</i> _____	5	<b>8. Shot Execution</b> _____	14
• <i>Strings and cables</i> _____	5	• <i>Commanded triggering</i> _____	14
<b>3. Initial Set-up</b> _____	6	• <i>Smooth or progressive triggering</i> _____	14
• <i>Draw weight</i> _____	6	• <i>Surprise release generated by a     Continuous Draw Increase</i> _____	15
• <i>Draw length</i> _____	7	• <i>Executing the shot</i> _____	15
<b>4. Accessories</b> _____	8	• <i>Follow through</i> _____	17
• <i>Arrow rest</i> _____	8	• <i>Three outcomes of a shot</i> _____	17
<i>Installation</i>		• <i>Breathing</i> _____	17
<i>Center shot</i>		<b>9. Tuning</b> _____	17
• <i>Nocking point/loop</i> _____	9	• <i>Basic tuning</i> _____	17
• <i>Sight</i> _____	10	• <i>Paper tuning</i> _____	18
• <i>Peep Sight</i> _____	10	• <i>Fine tuning</i> _____	19
• <i>Stabilizers and weights</i> _____	11	• <i>Other tuning/set-up tips</i> _____	19
<i>Weight</i>		<i>Sting and cable lengths</i>	
<i>Vibration reduction</i>		<i>Peep roll</i>	
<b>5. Arrows</b> _____	12	<i>Long distance sighting</i>	
• <i>Indoor</i> _____	12	<b>10. Maintenance</b> _____	20
• <i>Outdoor</i> _____	12	• <i>Maintenance suggestions</i> _____	20
• <i>Length</i> _____	12		
• <i>Spine</i> _____	12		

## 1. Diagram

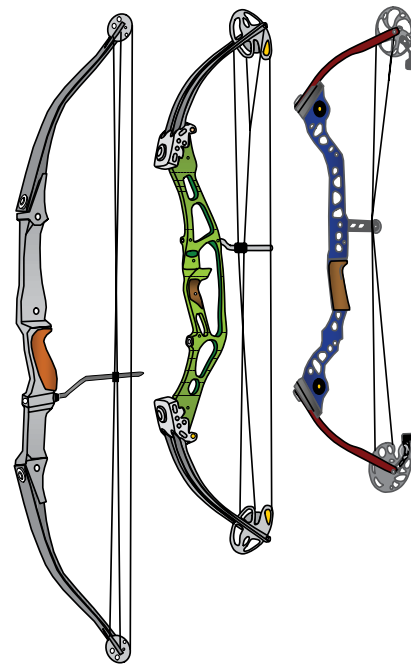
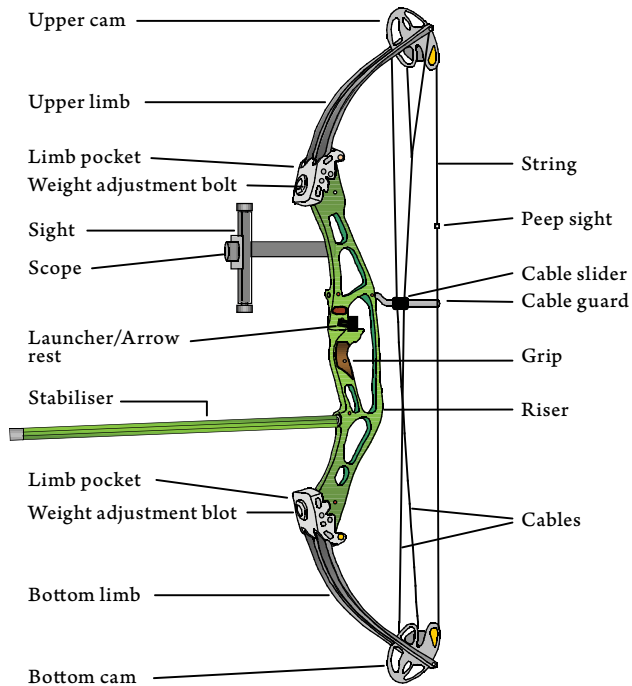

## 2. The Compound Bow

### *Axle to axle length*

The overall length of a compound bow is measured from axle to axle (the axle is the shaft through the limbs that the cams are mounted on).

Currently compounds range in length from 30" to 48" axle to axle. Shorter bows are commonly considered difficult to shoot and not as well suited to target archery as longer bows. Bows with very long lengths, above 45", are generally forgiving to shoot but tend to be much slower than shorter bows. Most compound target archers shoot a bow with a length between 38" and 43" for shooting with a mechanical release.

### *Riser design*

There are three common riser designs: reflex, deflexed and straight. A reflex riser curves rearward with the grip set behind the limb pockets. The deflexed riser curves forward with the grip ahead of the limb pockets, the grip is further from the string than the limb pockets are. As the name implies the straight riser is straight with the grip and the pockets in line, parallel with the string.

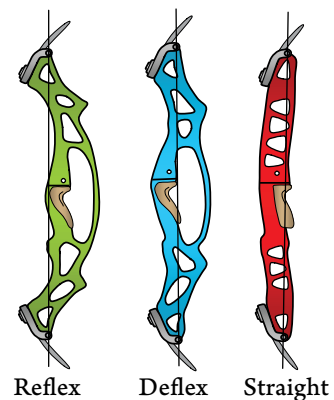

Reflex      Deflex      Straight

The reflex riser is the most widely available. This design typically offers a very balanced feel with good arrow velocities due to the lower brace heights associated with them. The reflex design is more susceptible to problems with hand torque and is considered to be less forgiving than the other two designs.

The deflexed design is available on high end bows, but may be difficult to find in less expensive models. This design is less popular due to its lower speeds that result from higher than average brace heights. This shape is less susceptible to the effects of hand torque. The high brace heights and shape of this design make it the most forgiving design of the three.

The straight riser is of course the average of the other two designs. This is true of not only the shape, but also the features and benefits of the shape. Very few bows are marketed with a perfectly straight riser.

As indicated above the riser design plays a part in the brace height of the bow. Brace height is the distance between the throat of the grip and the string when the bow is in the braced position (not drawn). A lower brace height extends the power stroke of the bow by pushing further forward on the arrow than a higher brace height. By pushing on the arrow for a longer period, more energy, speed, is imparted on the arrow. This increase in speed may be an advantage, however the increased amount of time that the arrow spends on the string, means that there is more time for the archer to make an error, or more time for errors to affect the arrow. Bows used for target archery generally have a minimum of seven inches of brace height. Most target bows' brace height falls between seven and one half inches and nine inches.

**Draw force curve**

A draw force curve is a curve on a graph that represents the stored energy of a bow. Along the "Y" axis is draw weight, and along the "X" axis is draw length or power stroke of a bow. Power stroke is the distance that the bow-string pushes on the arrow. Power stroke is equal to:

- The draw length minus
- The brace height of a bow and something more (because the arrow leaves the string after the string has passed brace height).

The curve in graph 1 represents the energy stored when a Recurve bow is drawn. The draw weight of this bow continuously increases as the bow is drawn back. The shaded area under the curve represents the amount of energy stored in the bow at full draw.

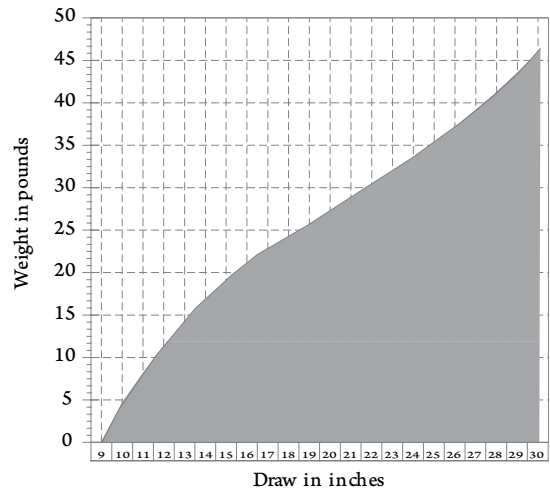

Graph 1

The curve in graph 2 represents the energy stored once a round wheel compound bow is rotated. The draw weight of this bow increases as the bow is drawn to peak weight and then lets off to a lighter holding weight when full draw is reached. The shaded area under the curve represents the amount of energy stored in the bow at full draw. Notice that more area is shaded indicating the increased energy stored in a compound bow as compared to a Recurve bow.

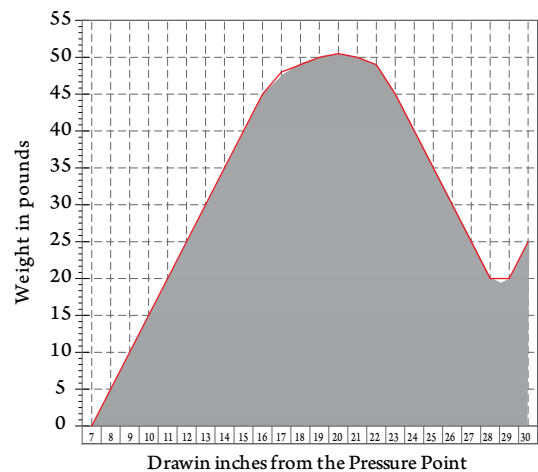

Graph 2

The curve in graph 3 represents the energy stored when a hard cam compound bow is drawn. The draw weight of this bow increases quickly as the bow is drawn, remains (dwells) at peak weight for a longer distance and it lets off to a lighter holding weight near the end of the draw. The shaded area under the curve represents the amount of en-



ergy stored in the bow at full draw. Notice that this cam design has the most shaded area indicating the increased energy stored by a hard cam compound bow as compared to the two previous examples.

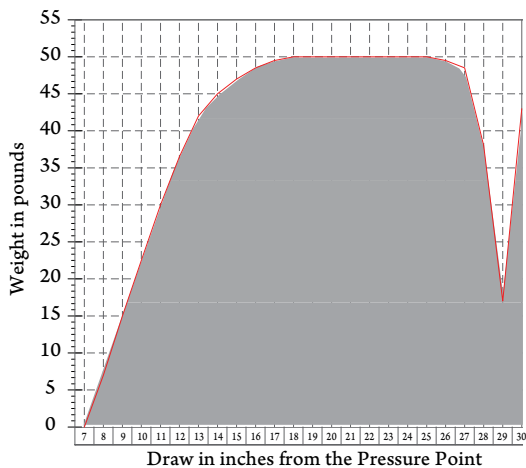

Graph 3

Increasing the peak weight of a bow or lengthening the draw length/power stroke of a bow increases the amount of shaded area below the curve. This increased shading represents the increase in energy or ultimately arrow velocity that results from these changes.

### *Eccentrics*

There are many eccentric systems on the market. Each style of eccentric offers a different set of features and benefits. The axis of the “Eccentrics” is not suspended centrally but eccentrically to achieve a mechanical advantage. Traditionally Eccentrics have been classified as cams or round wheels. Cams are elliptical in shape, which result in a large amount of stored energy and high arrow velocities. As the name implies, round wheels are round in shape, this results in less stored energy, lower velocities and a smoother pull. There are also several eccentric styles within the cam category. These consist of one cam, Hybrid (cam and one half) and two cam systems. When properly tuned, as outlined in section 9 of this chapter, these cam systems all shoot well.

When choosing a bow, keep this in mind. All string and cable assemblies stretch some amount, some more than others. Once the string and cable assembly on any

of these eccentric systems stretches, the bow is no longer the same as it was when it was initially set up and tuned (see sections three and nine of this chapter). The draw length, poundage, cam position, brace height, axle to axle length, let-off and nocking point position all change with this stretch. To make the bow shoot as it did when first tuned, small adjustments to the string and cable lengths will be required. On most bows, a few twists to the string and cables will return them to their original length. Consult the bow owner’s manual for the optimal “timing” or “cam position” for the eccentric system on your bow.

Let-off refers to the amount of reduction in draw weight that occurs when the eccentrics of a compound bow roll over. This is expressed as a percentage. For example a bow with 75% let-off and 60 pound draw weight will be 15 pounds holding weight after the cams roll over at full draw. Bow manufacturers offer cams with let-off percentages that typically range from 60% to 80%. For shooting with good form and back tension, the increased holding weight found on bows with lower let-off may be desirable.

There are several ways to slightly reduce the let-off on some bows that do not have adjustable let-off. One of these ways is to shorten the string to shorten the draw length and roll the cam position back. The draw length may then be adjusted to its original draw length by replacing or adjusting the draw length module. Another way to reduce let-off is to increase the diameter of the buss cable where it crosses the axle at full draw.

### *Strings and Cables*

Select the number of strands that results in the proper diameter string for the cam groove diameter. The string should fill the cam groove, but not be wedged into the groove.

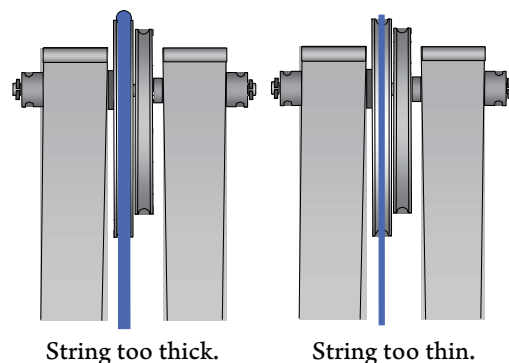

Select the diameter of serving material for the center serving providing the proper diameter to fit the nocks on the arrows. The nock of the arrow should snap on the string without any side to side movement, dragging slightly as it slides up and down the string.

### 3. Initial Set-Up (before tuning)

#### *Tiller*

Tiller is the relationship between the base of the bow limbs and the string when the bow is at brace. To measure tiller, use a bow square or ruler held perpendicular to the string to measure the distance between the limb where it enters the limb pocket and the string. The distance measured for the top (a) limb can be compared with the distance measured for the bottom limb (b) to determine the tiller setting of the bow.

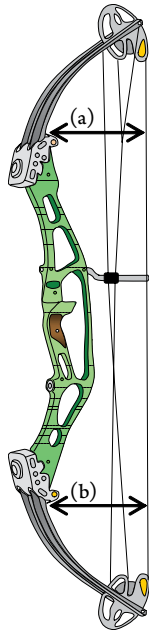

There are many opinions on how the tiller of a compound bow should be adjusted and the effects of such adjustments. If most of the archers strive to get the same distance “base of top limb / string” as the distance “base of the bottom limb / string” some believe that whatever the initial setup of the tiller, as long as the bow is tuned, it doesn’t make any difference how the tiller is set on a compound bow.

To adjust the tiller of a compound bow one or both weight adjustment bolts, limb bolts, are turned with one changing position more than the other. Tightening a bolt will decrease the measurement for the end of the bow that the bolt is on. Loosening the bolt increases the measurement. Adjusting the tiller of a compound bow will affect the following items; draw weight, the angle of the riser between the limbs in relation to the string (grip angle), the relationship between the nocking point and arrow rest and brace height. Adjusting the tiller of a compound bow will not effect synchronization of the cams or the strength of the limbs.

There are two methods commonly used to adjust tiller. One method is to measure the tiller and adjust the bolts until both ends are even. The other is to tighten the bolts until the limbs are as tight as they go, then turn the bolts back in even amounts until the desired draw weight is achieved. The second way depends on the precision with which thread of the bolt and the riser had been manufactured. An archer may wish to consult the bow owner’s manual for recommended settings.

Many of the newer cam systems have different shaped eccentrics on the top and bottom limbs. As a result the tiller may be uneven when the limbs are adjusted to the same point. These different shaped eccentrics may also cause the tiller measurements to change unevenly when string or cable lengths are adjusted. If an archer wishes to measure tiller and the eccentrics are different in shape, a piece of thread may be tied between the axles that go through the limb tips, and a measurement between this thread and the limb may be used.

To check or adjust the tiller on a bow that has virtually parallel limbs; it may be necessary to measure between the upper limb pocket pivot point and the bottom limb cam axle (a), then compare this to the measurement between the bottom limb pocket pivot point and the upper limb cam axle (b). To make an adjustment the limb bolts can be adjusted as previously mentioned.

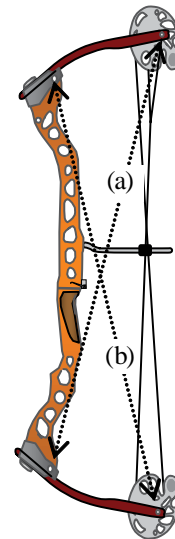

It is advisable to check with the manufacturer for the correct procedure and expected results.

#### *Draw weight*

FITA rules limit the draw weight to 60 lbs. Setting draw weight light enough to be easily managed allows an archer to learn to shoot with proper form and develop good hab-

its. When adjusting the draw weight for an archer, make sure the bow is drawn using the muscles of the back. As an archer's strength increases, the weight may be increased. Regardless of what the draw weight is, the archer should be able to shoot a full FITA in one day without excessive fatigue. The archer should have enough strength to execute the last shot with the same proper form as the first shot.

Heavier draw weights make it easier to reach 70 and 90 meters due to a flatter trajectory as well as performing better in the wind. Trajectory is the arc of the arrow.

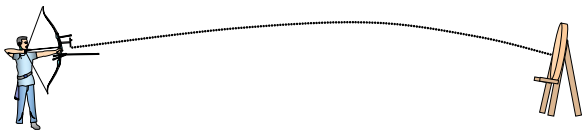

*Higher trajectory when shooting a recurve bow.*

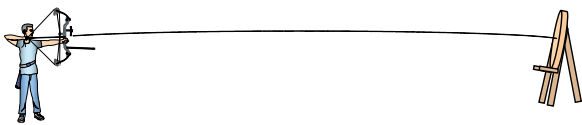

*Flatter trajectory when shooting a compound bow.*

With a lower arc, it is easier to sight in at longer distances without the sight having to be adjusted into the path of the arrow.

Another advantage of a flatter trajectory is the reduction of errors from the miss-estimation of distance. This is particularly beneficial for field archery and other unmarked distance shooting.

### **Draw length**

A proper length gives leverage and control over the bow as well as leverage to generate back tension. A proper draw also allows for clearance for the string at the chest and bow arm. Set the draw length so the release hand can find a stable spot, for instance: against the jawbone (popular), depression behind the ear... See "Facial marks" from the FORM Chapter. Having the stable release hand helps to steady the bow as well as properly positioning the draw arm. The drawing elbow should be located directly behind or slightly outside the line of the arrow while at full draw. If the elbow is rotated behind the head, the draw length is too long. The drawing elbow should also be held up to or above the line of the arrow.

When measuring a new archer for their draw length, pay close attention to the position of head, anchor point,

bow shoulder, bow arm and posture. Archers will naturally try to mold to or fit a compound bow, because it has a pre set stopping point. Archers may lean their head or torso to fit a bow that is too long, or they may hunch to fit a bow that is too short. It is important to fit the bow to the archer not the archer to the bow. An exceptionally light weight Recurve bow, a light draw weight compound bow with no let-off, or an elastic band attached to a bow to represent a light weight draw string may be used in conjunction with a draw length arrow to determine an archer's proper draw length. A draw length arrow is one with preprinted marks indicating the length to which the bow is drawn.

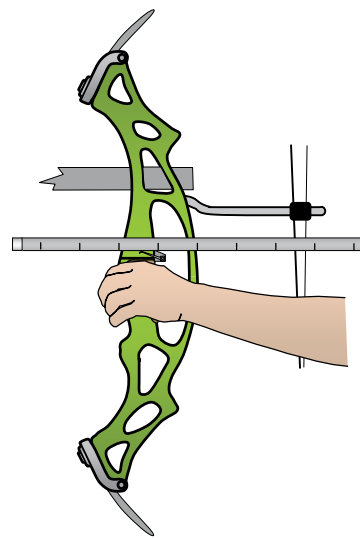

Keep in mind that regardless of the method used to initially determine an archer's draw length, adjustments may need to be made as the archer progresses. A bow with an adjustable draw length may be desirable for beginning archers.

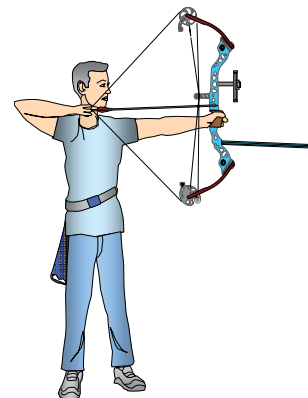

When purchasing/selecting a bow it is important to understand how manufacturers measure draw length of the bow. The ATA, Archery Trade Association, formerly the AMO, Archery Manufacturers Organization, states that the draw length of a bow is one and three quarters of an

inch longer than the distance from the string at full draw to the throat of the grip. Most manufacturers represent the draw length of their bows in this manner.

Measured draw length = nocking point to the far side of the bow.

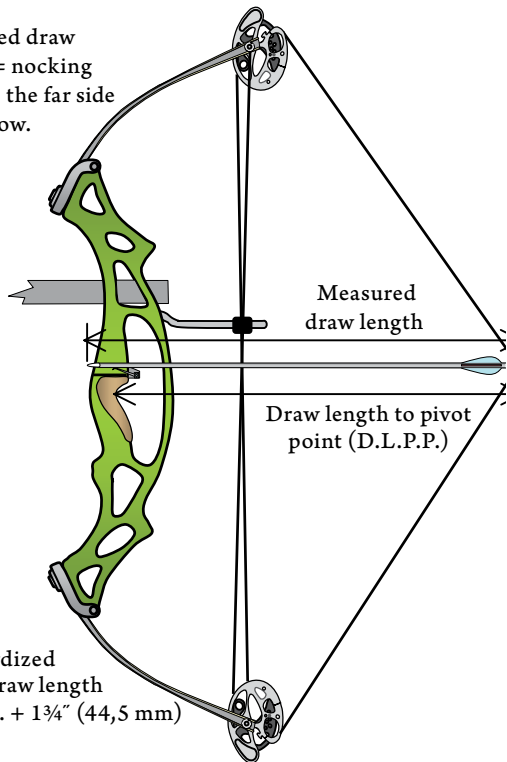

Standardized AMO draw length  
D.L.P.P. + 1 3/4" (44,5 mm)

#### 4. Accessories

##### *Rest*

An arrow rest should be very solid and consistent. It should also be adjustable enough to make tuning easy. The "Pacesetter" or "lizard tongue" style of arrow rest is easy to tune and forgiving to shoot. .008" or .010" blade thickness works well with light weight arrows. With these thinner sizes, it is easier for the arrow to "push through" the blade if there is unwanted contact with the arrow. The arrow may fall off of this type of rest during the draw if an archer is not in good physical condition. In this case use a heavier launcher blade. If the arrow repeatedly falls off of the rest, the archer will become fatigued and discouraged.

Fall away arrow rests are gaining in popularity. These arrow rests are designed to move away from the arrow at the point of release, so the fletching does not contact the rest.

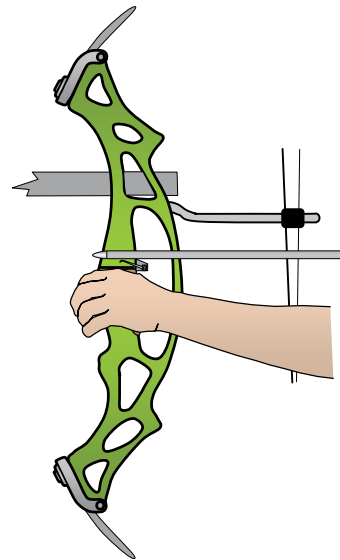

As a starting point mount the rest so that there is approximately one inch (25 mm) of the arrow in front of the rest.

6

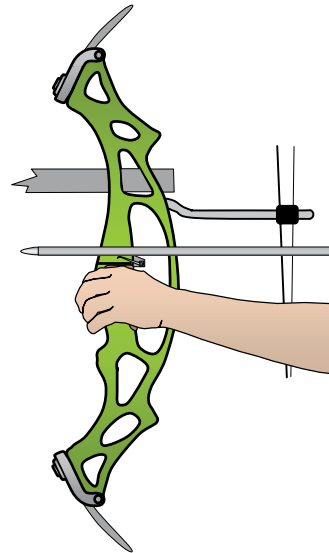

When the rest begins to fall the arrow should have travelled approximately 3 inches (75 mm). If the distance is greater than 3 inches (75 mm), the rest, due to the speed of the arrow, may not clear the fletchings. It is imperative that fletching clearance is confirmed after this adjustment which can be checked by spreading the fletching area with some (foot) powder. Spray the fletching area of the arrow with foot powder, taking care not to disturb the powdered area, shoot the arrow into a firm Butt. Inspect the powdered area of the arrow for marks which may indicate contact problems.

Mount the arrow rest on the bow so that the center of the arrow shaft is at or slightly below the center of the mounting bolt. FITA rules require that the point of the rest that contacts the arrow be no more than six centimeters behind the low point of the throat of the grip. For

maximum forgiveness, the rest should be placed between zero and three centimeters behind this point.

Center shot is the point at which the arrow is directly in line with the path of the string. To adjust center shot, place an arrow on the bow and point the bow away from you. Line a point on the string approximately one inch below the top cam up with the string that is in the groove wrapped around the cam. Without moving, glance down to the center of the string and the arrow. When the bow is in center shot, the string will appear to run right down the center of the arrow.

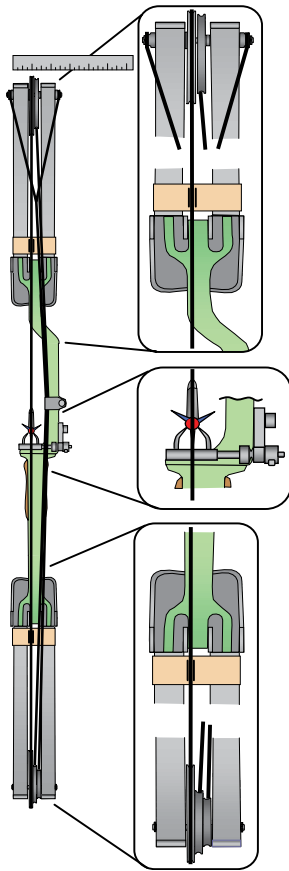

Limb alignment gauges can be used for this section, but as there are many types of bows and set-ups the following is a suggested method of the procedure:—Measure across the end of the limbs with a rule, find the centre, then measure the distance from this centre point to the centre of the string track on the cam. Stick a piece of masking tape across the limb just at the end of the riser. Find the centre of the limb at this point and put a small mark on the masking tape. From this point add the same distance as the offset of the string and make a mark, then put a heavy pencil mark either side of this point approximately the width of the string.

These two lines can then be used to visually line up the string. If a release aid is to be used, the rest can then

be adjusted to move the arrow in or out from the riser to get the string alignment so that the string passes straight along the arrow. If this bow is to be shot off the fingers then the pyle of the arrow needs to be slightly out to the left of the string (known as the archer's paradox). This setting is required to compensate for the interference the releasing fingers have on the string, which in turn affects the initial flight of the arrow.

The drawing shows a right-handed bow set-up.

If limb alignment gauges are used care must be taken that the gauges are close to the top and bottom of the riser and that they are properly attached to the limbs.

It is not imperative that this adjustment be absolutely perfect, as the rest will likely be re-adjusted during the tuning process.

### ***Nocking point/loop***

The height of the nocking point on the string should be set so the arrow appears to be level when the bow is held straight up and down. That is the arrow is perpendicular to the string. Once again this setting is not critical, as it too will be moved in the tuning process.

Hand tied nock sets and a rope release work very well. A string loop is also popular. There are three effective ways to tie a string loop. The first is to tie the top and bottom knots equally spaced above and below the arrow.



With this loop the release will be pulling from a point slightly above the nock of the arrow. This results in very little pressure from the arrow on the arrow rest. With very little downward pressure, it is somewhat easier for the arrow to fall off of the rest.

The second loop is the same as the first with the addition of a nocking point placed below the arrow inside of the loop.





This brings the pressure of the release down directly behind the nock of the arrow and puts some downward pressure on the rest, thus might be preferable in windy conditions.

The last loop has a nocking point above the arrow and both the top and bottom knots of the loop tied below the arrow.



This loop results in the same pressure on the string and rest as a rope release applies. This loop may be shorter in length, because there is no need to leave room for the arrow nock between the release and the string.

### **Sight**

A sight should be easily and accurately adjusted with a reliable locking system. Having a level on the sight is important for shooting distances beyond 18m. Canting the bow affects the impact of the arrow greatly at longer distances. Level the sight bar and scope with the bow so windage does not change when the elevation is adjusted.

A scope on a compound bow consists of a housing with a single lens and a level.



The power, magnification, of the scope lens is based on personal preference. Four and six power lenses are most common. The higher the magnification the lens has the more detail you will see of the target. The higher power not only magnifies the target, but it also magnifies the appearance of the archers wiggle. Seeing too much wiggle may be detrimental. Choose scope housing color, diameter and peep sight size so that it is easy to center the scope accurately in the peep. A black scope, peep and aiming dot is easy to center and focus on. Black is a soft color and easy for the eye to focus on. Choose a peep diameter that allows you to see a narrow ring of light around the outside of the scope housing. This will help to keep the peep centered on the scope. When aiming with a peep sight and a level, the archer should center the peep on the scope and check the level before focusing on the dot in the scope or the target. Once the focus shifts to the dot or target, it should remain there. The peep and the level should not distract the archers aiming.

To install a sight on a compound bow, bolt the sight on the riser and set the sight extension at the length it will be shot at. Pulling the extension in close to the riser will cause the archer to see less detail while aiming as well as less perceived wiggle. Extending the sight shows more detail for finer aiming as well as magnifying the appearance of wiggle. Place the bow so the string is vertical in all directions or plum.

Next place a level against the vertical adjustment bar.

Loosen the screws that hold the bar onto the extension and adjust the bar so that it is level. Re-tighten the screws on the bar. With the level against the vertical bar, loosen the scope on the sight block and adjust it until the level in the scope matches the level on the vertical bar.

Re-tighten the scope on the sight block.

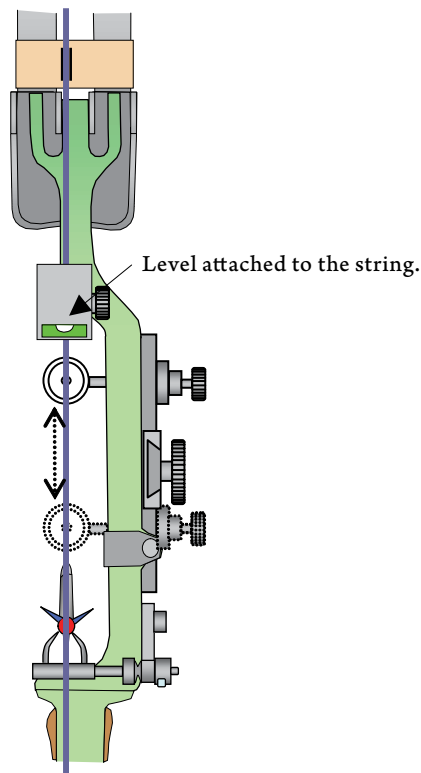

Archers who intend to shoot field archery may then wish to rock the bow forward and back with a level along the string to see if the third axis of the scope needs to be adjusted. If the bubble moves left and right in the scope when the bow is pointed up and down, loosen the third axis adjustment screws and rotate the scope until the level no longer changes when pointed up or down. Consult the owner's manual for the sight to find the proper screws or adjustments for the third axis.

Sights designed for Recurve bows may not withstand the vibration of a compound bow.

### **Peep Sight**

A peep sight is the rear sight on a compound bow. Peep sights are available with and without clarifier lenses. The use of a clarifier lens is a matter of personal preference.

To install the peep, place the bow in an appropriate press and relax the string. Place the peep between the strands of the string approximately four inches above the nocking point and remove the bow from the press. Adjust the scope on the sight to a position that will be correct for 50 or 70 meters for outdoor shooting or 18 meters for indoor shooting. Next the archer draws the bow while another person slides the peep up or down the string to position it in front of the archer's eye.

**Safety:** when adjusting the peep sight do not have the hands in front of the string – the archer may inadvertently release the string and an injury may be caused. Note the thumb is away from the trigger on the release aid.



The archer may wish to draw and anchor with closed eyes, so the current position of the peep does not influence its final setting. Tie the peep sight into the string so it cannot fly out in the event of a bow breakage or dry fire. The bow string may need to be twisted to make the peep turn properly to see through it.



### **Stabilizers and weights**

A properly weighted bow will have a slow wiggle around the middle of the target. This wiggle will often appear to take the shape of horizontal figure eight on the face of the target. If the bow is too light the sight will wiggle very quickly around the face of the target. If the bow is too heavy the sight will be steady but slowly bounce up and down as it drops out of the bottom of the target while aiming. Keep the weight on the lower part of the bow. A low center of gravity is easier to hold steady.

Stabilizers may also incorporate shock-reducing features such as carbon rods, rubber dampeners, etc. Some of these items are affixed on the bow limbs. They can make the bow more enjoyable to shoot. Shock reducers also help prevent vibration from harming sights, arrow rests and the archer's joints.

## **5. Arrows**

### **Indoor**

For indoor shooting, high quality large diameter arrows are recommended. According to FITA rules the diam-

eter may not exceed 9.3mm. Fletching on indoor arrows ranges from two inch vanes to five inch feathers. Personal preference plays a large part in selecting fletching for indoor arrows.

### **Outdoor**

Smaller diameter aluminum/carbon or carbon arrows are better suited to shooting outdoors. The smaller diameter and lighter weight of these arrows makes it easier to reach 70 and 90 meters, as well as performing better in the wind. Heavy point weight is considered beneficial for shooting long distances. 90 to 125 grain points are common depending on arrow size and weight. One and a half to two inch vanes are most common on outdoor arrows. "Spin Wing" type vanes may be more likely to contact the arrow rest of a compound bow, and are not typically used for this purpose. If an archer wishes to try this type of vane, a fall away style rest may be in order.

In order to produce the most consistent arrows possible, all arrows should be fletched on the same fletching jig. Arrows should be numbered so each arrows performance can be evaluated, and problem arrows can easily be identified.

### **Length**

To determine the proper arrow length use an arrow with a scale on the side of it or use a full length arrow that may be marked. Place the arrow in the bow and draw it back to full draw. It is important to do this with the release that the bow is to be shot with, because a different measurement will result if the bow is drawn with fingers. Once the archer is at full draw, another person may mark the shaft or read the length at a point that is one inch in front of the contact point of the arrow rest. The length the arrows are cut to changes the way they react in regard to stiffness. If the stiffness needs to be changed, this length may be altered somewhat.

### **Spine**

When selecting arrows for indoor or outdoor shooting, it is important to select a shaft with the proper spine, stiffness, for the bow they are to be shot out of. To select the proper spine make note of the draw weight, cam type and proper arrow length. With this information, the arrow manufacturers sizing chart may be referenced to find the appropriate shaft size.

## **6. Release**

### **Release aid styles and descriptions**

There are countless releases on the market. For practical purposes we can group them into three categories: Pure back tension releases, hand held releases with a trigger and wrist strap releases.



Thumb release



Thumb release with wrist strap



Finger release with wrist strap.



Second Finger and wrist pull with finger release.



Activates on increased holding pressure.



Back tension release.

Pure back tension releases are a hand held release that does not rely on a trigger to fire.



These releases fire as a result of changes that occur in the head of the release when the archer pulls with fingers on the release.

Hand held releases with a trigger have a button or trigger that is manipulated to cause the release to fire.



The wrist strap release straps onto the wrist behind the hand.



This allows the bow to be drawn using the wrist and arm leaving the hand relaxed. The wrist strap release also has a trigger which is manipulated which causes it to fire.

Many archers believe that hand held releases are more suitable for executing a surprise release by the use of the muscles located in the archers back and posterior part of the string shoulder, any of these three types of release aids can generate such a “surprise release”. Nevertheless archers will find this achievement more or less easy pending the release aid design. This is why a personal research has to be done by testing various release aids.

More about the release technique in “Shot Execution” of the FORM Chapter.

## 7. Form

### *Level I Manual*

The basic form used to shoot with a compound bow is essentially the same as described in the FITA Level 1 Coaching Manual for shooting a Recurve bow. There are a few exceptions as listed below.

### *Bow arm/hand*

With a low wrist grip, and the pressure at the bottom of the palm, the bones in the wrist support the bow. Using bones to support the bow is more consistent than using muscles, as the bones do not change. The pressure of the bow should be placed at the bottom of the palm between the muscles, on the thumb-side of the lifeline. The pressure on the bow riser should be slightly below the center of the grip with the thumb and index fingers all the way at the top of the grip. This pressure should be focused on the left edge of the riser for right-handed archers. The knuckles of the bow hand should be at a forty-five degree angle from the vertical line of the grip. This angle will result in a space between the little finger side of the palm and the riser. The fingers of the bow hand should be totally relaxed on the front of the grip, but not open. The arm may be bent downward slightly or straight but not locked. The shoulder should be as low as possible



When shooting with the proper bow hand position as described above, the bow may fall out of the hand upon release. A sling is a strap or cord used to prevent the bow from falling. The sling can be permanently mounted on the bow, or may be attached to the fingers or wrist of the bow hand and simply wrapped around the bow while in use. The sling does not hold the bow in the hand, but rather catches the bow when it begins to fall. If the sling is adjusted tightly to hold the bow in place, the sling can impart unwanted torque on the bow. The bow may typically be allowed to fall into the sling a distance about as long as the thumb.

### *Facial Marks*

This technical element was formerly named “anchor point”; it is the position that the drawing hand is consistently placed on the jaw or face of the archer while aiming and executing a shot. Depending on the style of release



aid, it is common to place the thumb or knuckles of the draw hand against the jaw as part of the anchor point. The tip of the nose is typically placed on the string as an additional reference point. Archers wearing eye glasses may not be able to position the tip of the nose on the string and still see properly. In this case the head may be held erect and slightly turned in order to see through the lens. The anchor point is very important, however it is not as critical with a compound bow equipped with a peep sight as it is with a Recurve bow without a peep sight. The peep sight provides consistent aiming by requiring the eye to be properly aligned behind the sight in order to see through it. This results in less reliance on the anchor. The anchor point becomes very consistent as a result of the repetitious nature of practice.

## 8. Shot Execution (Release)

There are various techniques for executing the shot. Below we will make some comments about some combinations of the following 4 principles:

- 2 will refer to the “intention” of the shot: “Commanded release” and “Surprise release”
- 2 will refer to the part of the body generating the shot: “Finger Triggering” (activate the trigger with a finger) and “Continuous Draw Increase” (Back Tension, body extension / spreading ...).

It is useful to know the following methods when teaching the proper use of a release.

### Commanded triggering

The name of this technique is self explanatory: this is a combination of:

- A triggering action—a finger (suddenly) activates the trigger (\*).
- On command (when the visual/aiming references have reached an enough good quality level).

This technique has a limited field of efficient action: when it is very windy.

Otherwise, the mental order that the archer has to send to his finger embeds a perfect follow-through and the shot happens while the archer is no longer aiming. Also a rapid finger motions often disturbs the overall steadiness of the archer. This is why this technique is also known as “Perfect aim and an imperfect shot.

Two classical bad evolutions of this technique are:

- “Punching” the trigger, a technical mistake known as “finger hit” in shooting,

- Target panic.

(\*) *This technique is also possible when using a release aid without a trigger: the archer suddenly changes the angle of the release hand; as above it is usually not a recommended technique.*

### Smooth or progressive triggering.

This is a combination of a triggering action (a finger activates the trigger) but so continuously that the string is surprisingly liberated by the trigger. (\*\*)

In this method the bow is aimed at the target and the trigger is continuously squeezed (usually slowly) while maintaining the muscular tension in the archer’s back. A proper squeeze on the release should result in a surprise shot when the trigger gets off and the string is released. If implemented this way, it is an excellent method!

There are two common problems with this method.

- a) The archers does not provide a continuous squeeze toward the end of the draw, but command the release with some sort of punch as described above, due to:
  - Either some impatience: the archers has a stable sight for a while and the continuous squeeze has not yet allow the triggers to go off;
  - Some fair of the surprise release. The archer is afraid that the trigger will go off when the sight will be out of the target centre.
- b) The archer regulates the speed of squeezing according to his aiming quality:
  - Quite fast squeeze when the peep, scope and target are well centered,
  - Slow squeeze (or worst. stop squeezing) when unstable, misaligned or the wiggle is important.

When this “regulation” applies we are very close to the technique of “Commanded triggering” as described above and the mental activity is split on the sighting and squeezing activities. Nevertheless it would not be efficient to continue squeezing the trigger t the same pace, when the sight is really away from the target centre! Hence some “regulation” skill has to be developed in case of abnormal sight wiggling, as long as the archer does not “fall” in the commanded triggering as described above.

(\*\*) *This technique is also possible when using a release aid without a trigger through 2 alternatives:*

- *The archer progressively changes the angle of the release hand; this alternative is usually not recommended.*

- The change of angle of the release aid is achieved by activating the muscles of the archer's back and/or posterior part of the string shoulder. This technique is described below.

Notes about the above Triggering methods (Commanded or Smooth/Progressive):

A huge percentage of Compound archers (probably more than 90%) are learning to shoot by “manipulating” the trigger. The reason they manipulate the trigger is because it is easier to learn and results in instant results, however short term they may be. Among the most frequent negative long term effects of the improper use of releases, we can report:

- Back and shoulders muscles relaxing before the shot is over.
- Target panic

### Surprise release generated by a Continuous Draw Increase

According to some experts, this is THE technique. It is a fact that over the last 15 – 20 years, this technique has become quite popular among the elite Compound archers.

This method of shot execution is often called “back tension”. With this method the archer aims at the target and increases tension in the back and/or posterior part of the string shoulder, regardless of where the sight goes. Of course the archer always has the option to let the shot down and start over if they do not like where the sight goes. The outcome of this method is a surprise release resulting in perfect form. One of the main advantages of this method is that it keeps the archer's mind away from the trigger and trigger hand, allowing an excellent follow-through (see further down)

Notes about the surprise release (achieved through the 2 latest techniques presented above):

- In order for an archer who may be struggling with concept to experience the feel of a surprise release, the coach may squeeze the trigger of the release while the archer safely aims at a target.
- The sight may not be perfectly centered when the bow goes off. In opposition to the Commanded triggering method, this one can be summarized as “Imperfect aim and a perfect shot”, through which the arrow is guaranteed to hit inside the wiggle area of the sight because it is executed with perfect form while the subconscious mind makes the necessary corrections.

With practice, the wiggle area gets smaller and these groups get tighter.

- By strong wind, it might be more hazardous to solely use “Surprise release”.

### Executing the shot

The first order of business when teaching an archer to shoot with a mechanical release is to teach them how to safely draw the bow without prematurely releasing. To accomplish this, the archer should draw with their thumb and fingers off of the trigger of the release aid. For pure back tension releases, the archer may want to brace the release in a direction that will not allow it to fire by placing fingers against the back side of the release while drawing.

Illustration: draw safely with a “pure Back tension” release aid

When learning how to shoot a compound bow with a mechanical release the archer should shoot at short range at a blank bale. The blank bale is also a good place to perfect form and work on form improvements.

Once an arrow is nocked and the release is on the string, raise the bow to rest on the knees or hip. Support the bow by holding it up with the release so the bow hand can be properly set on the riser. Next, raise the bow to the height of the target and draw on target with the arrow as much parallel to the floor as possible. Pause between raising and drawing the bow to allow for a smooth draw and prevent the arrow from falling off of the rest.



*Safe Drawing Angle.*

Some archers tend to come down with elbow and hand while drawing back to make the draw easier (they instinctively use additional muscles which help them to overcome the peak weight); although the bow hand is kept in the same position the arrow point will then be higher than the nock; if something breaks during that ac-

tion the arrow may fly way over the target and cause accidents; this should be avoided under all circumstances.



*Unsafe Drawing Angle.*

The sight should be at the center of the target when full draw is reached. The sight will not remain on target during the draw, due to the motion and effort necessary to draw, but it should start and finish on target.

When full draw is achieved, place the draw hand in the proper anchor position and begin the aiming process. Look through the peep sight and center it on the scope housing. Check the level.

At this point, focus on either the sight or the target, but not both. Choose one and be consistent. The eye cannot focus at two distances at the same time; this is why one is chosen. Focusing on only one item also makes it easier to accept the wiggle area of the bow. Do not try to hold the bow still, let it float or wiggle. The subconscious mind will automatically keep the wiggle of the sight centered on the target. "Trying" to hold still will cause more wiggles than simply trying to relax. Consciously trying to force the sight on the target causes unnecessary muscle movement in addition to the movement called for by the subconscious. If the archer chooses to focus on the target, try using a very small dot or a ring on the scope lens that can easily be ignored by the conscious mind. If the archer chooses to focus on the sight, try a large dot on the lens that makes it easier for the conscious mind to ignore the target. To explain this system, compare it to watching television while a bug is flying around the room. If a person is focused on the television program they will not notice the movement of the bug. The bug would only be noticed if it lands on the television screen. This is the same as focusing on the target causes us to accept or not notice the movement of the sight. In the case of focusing on the sight instead of the target, if this person is focused

on the bug they cannot watch the television. It is the same principal either way.

When using a pure back tension release (a trigger-less hinge type release), begin to pull at this point. If a release with a trigger is being used, move the thumb or finger onto the trigger while centering the peep and checking the level. Apply approximately one half of the pressure necessary to release the trigger. Once the thumb or finger is properly set on the release, begin to pull with the back and/or posterior string shoulder muscles, as if pulling a bow through the clicker. When the proper muscles of the back are used for this pull, the bicep of the drawing arm is relaxed. The tension in the release hand does not change at all, no increase and no relaxation.

Entry to intermediate level archers holds the bow at full draw with their back and arms and press the trigger with their finger. Many of these archers "creep" as they aim, indicating a decrease in back tension while at full draw.

Once the pull with the back muscles begins, there is absolutely no conscious thought about the release hand whatsoever. After gaining an understanding of this, the draw does not need to be stopped to check peep, level and set thumb. The draw will become a slow constant pull throughout the shot. Again, this pull is the same as pulling through the clicker on a bow.

Changes in the body while pulling will cause the release to fire all by itself. There is no need for thoughts about when or how to shoot the shot ever again. Once the pull is started the archer must be willing to pull forever; aiming and pulling with no expectation that the shot will ever go off.

Although it is important to trust the back tension system to work without using conscious thought to execute the shot, some archers may wish to know what causes the release to fire. Continuing to pull on the release with back tension increases the pressure between the hand and the release because the compound is shot from the wall. The increase in pressure causes the back of the hand to stretch. As the hand stretches the thumb or trigger finger moves rearward at a rate that is faster than the rate that the release moves. The trigger moves with the thumb or finger that it is in contact with. When the trigger moves far enough the string is released. With a quality release this movement, change in relationship between the hand and the release, is not typically visible or felt. Keep in mind that there

is no conscious change in the relationship between the hand and the release.

Calmly talk the archer through this process of execution with each shot as they learn how to execute a proper shot. By doing this the coach is performing the function of the mental program for the archer. Once the proper method is learned and committed to the subconscious, the archer may be taught to use a mental program in order to control the shot the way the coach did.

### ***Follow through***

Shooting with back tension results in a “surprise” when the shot goes off; therefore there is no need for conscious thought about follow through. An analogy for this is people playing tug-o-war (pulling on opposite ends of a rope). If the rope were to break while people were pulling on it, there will be a surprise. The people pulling will fall onto their backs, without time to react in any other way. The bow moves straight toward the target that it is aimed at when the release goes off (the rope breaks). At the same moment, the release hand moves straight away along the same line. This occurs before the archer can react in any other way, allowing the arrow to leave the bow while everything is still in perfect line. The result is perfect follow through. There is no need to exaggerate the motion of follow through because the arrow is gone before the archer regains control after the surprise of the release. Again, no thought about follow through is necessary if the release is executed properly using back tension, resulting in a surprise. The perfect follow through is natural. The example of a rope breaking is an explanation used to demonstrate that with a surprise we can not control the follow through until after the arrow leaves and it no longer matters. Just as the people on the rope eventually react to their fall, we also react and re-grip the bow and regain control. This reaction occurs after the arrow has left, because of the element of surprise. A true surprise release ensures that the shot is achieved while the archer is still aiming; hence the bow can propel the arrow away while visual and mental activities of the archers are maintained and unchanged.

### ***Three outcomes of a shot***

This section is a short restatement of what must happen when the archer draws the bow. This information is so important that it is necessary it make it stand out from the other aspects of the shot. This is the “Keystone” of shooting properly with a mechanical release.

Three things can occur once the bow is drawn. First, the archer draws, anchors, aims and starts to pull. The pull continues with constant, even motion, never speeding up or slowing down, until the release goes off, surprising the archer and the arrow flies to the target. Second, the archer draws, anchors, aims and starts to pull. The pull continues with constant, even motion, never speeding up or slowing down, until the shot has deteriorated so badly that the arrow will not hit the target if it goes off. In this case the archer lets down and starts the shot over from the beginning. This is still a perfect shot, as the archer still has the opportunity to execute the shot properly. The third occurrence is the archer draws, anchors, aims and starts to pull. The pull continues with constant even motion, never speeding up or slowing down. This pull continues at the constant rate for an eternity. In this third scenario, the archer is standing at full draw for the remainder of his or her life. Of course the third scenario never occurs. Eventually all shots end in one of the first two results listed. If the third scenario never occurs, then why include it? Simply put, in order for the shot to be successful, the archer must intend to do number three every time the bow is drawn back. The archer must have no expectation that the bow will ever go off, this allows the surprise release to occur. With expectation comes anticipation. The archer must have endless patience with every shot.

### ***Breathing***

An archer should exhale when exerting the effort to draw a bow. Once at full draw the archer should aim and execute the shot before taking another breath. This time while the lungs are empty is referred to as the natural respiratory pause. It may seem difficult to spend this amount of time without breathing, but consider that we do not draw a breath while talking, and we often talk for periods longer than that required to execute a shot. An alternative to this is to draw a half or full breath after reaching full draw and holding that breath until the shot is completed.

## **9. Tuning**

### ***Basic Tuning***

As listed in section three of this chapter, the assembly and set-up of the bow and components is the first step in the tuning process. This step must be performed in order to learn to shoot with proper form. Once an archer has learned how to execute shots with proper form, the tuning process can resume.

### Paper tuning

The next step in tuning a compound bow is paper tuning. Stand two yards/meters from a frame with paper stretched tightly across it. Using good form, shoot fletched arrows through the paper and into a target butt. The holes in the paper may then be analyzed to determine adjustments that may be necessary to improve arrow flight. If the arrows make tears in the paper that are vertical or a combination of vertical and horizontal, make adjustments or corrections until the tear is perfect or only horizontal before making adjustments to correct for horizontal tears. Make only one change or adjustment at a time so the effects of the change can be properly measured. Ultimately the arrow will pass through the paper making a perfect hole with three equal length tears from the fletching. There are many resources available that detail other adjustments and considerations for this type of tuning. Easton Archery has produced much informational literature on this subject over the years. See the Easton Tuning Guide that you can download from <http://www.easton-archery.com/downloads.asp>

Paper tuning should not require a large amount of time or effort. Reasonable results should be achieved in just a few minutes and certainly should not take more than one hour.

- Perfect tuning

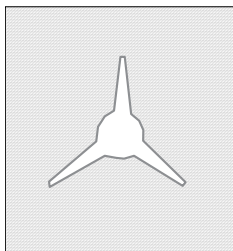

This tear indicates good arrow flight. The point and fletching enter the same hole.

There is no reason to contribute too much time paper tuning, because this is just a starting point for the fine tuning process that will take place when shooting at a target.

There are many factors affecting the flight of an arrow. Below are several suggestions for correcting arrow flight depending on the direction of the tear in the paper.

- Nock high

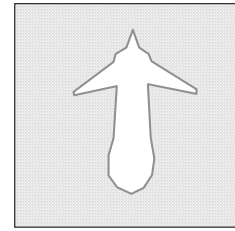

- Check cam timing/synchronization.
- Raise rest or lower nocking point.
- Soften spring tension or launcher blade on rest.
- Increase speed that fall away rest drops.
- Check for fletch clearance (spray foot powder on fletching and shoot).
- For long arrows, shorten arrow until point is approximately one inch in front of rest at full draw.
- For one cam or cam and a half bows, stiffen arrow (cut shaft, lighten point, larger shaft, reduce poundage).

- Nock low

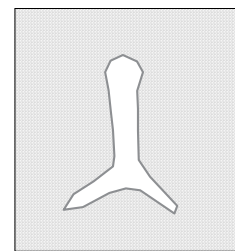

- Check cam timing/synchronization.
- Lower rest or raise nocking point.
- Stiffen spring tension or launcher blade on rest.
- Decrease speed that fall away rest drops.
- For one cam or cam and a half bows, weaken arrow (heavier point, longer shaft, smaller shaft, raise poundage)

- Nock left (right handed archer)

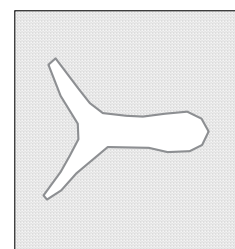

- Move arrow rest right.



- Confirm that archer is not torquing bow grip.
  - Weaken arrow (heavier point, longer shaft, smaller shaft, raise poundage)
  - Check for fletch clearance (spray foot powder on fletching and shoot).
  - Check for deflection of bowstring from facial contact (Aim at paper then pull face away from string slightly and execute shot).
  - Check for wheel lean/twisted limbs.
  - If items listed above do not correct flight, try to move rest left or stiffen arrow.
- Nock right (right handed archer)

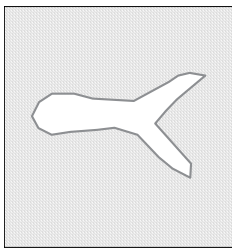

- Move arrow rest left.
- Confirm that archer is not torquing bow grip.
- Stiffen arrow (lighten point, cut shaft, larger shaft, lower poundage)
- Check for fletch clearance (spray foot powder on fletching and shoot).
- Check for deflection of bowstring from facial contact (Aim at paper then pull face away from string slightly and execute shot).
- Check for wheel lean/twisted limbs.
- If items listed above do not correct flight, try to move rest right or weaken arrow.

### ***Fine tuning***

This advanced step will be detailed in the level 3 coaching curriculum.

### ***Other tuning/set-up tips***

Below are listed several tips for common problems that may be difficult to solve.

Effects of lengthening/shortening the string or the cables. This may be achieved by twisting/untwisting existing string or cables, or by replacement with new ones.

#### **String**

- Shorten (twist)
  - Shortens draw length

- Decreases draw weight
  - Reduces let-off (slightly)
  - Raises brace height (slightly)
  - Increases tension of string and cable assembly in brace position
- Lengthen (untwist)
    - Lengthens draw length
    - Increases draw weight
    - Increases let-off (slightly)
    - Lowers brace height (slightly)
    - Decreases tension of string and cable assembly in brace position

Cables (referred to as bus cables or power cables)

- Shorten (twist)
  - Lengthens draw length
  - Increases draw weight
  - Increases let-off (slightly)
  - Raises brace height (slightly)
  - Adjust timing. On a two cam bow, shortening one cable will cause the cam it is attached to roll over slower. That is the cam will not be drawn back as far.
- Lengthen (untwist)
  - Shortens draw length
  - Reduces draw weight
  - Reduces let-off (slightly)
  - Lowers brace height (slightly)
  - Adjust timing. On a two cam bow, lengthening one cable will cause the cam it is attached to roll over further. That is the cam will be drawn back further.

Methods for correcting improper peep roll.

- Compress bow in press and move strands of string from one side of the peep to the other. An equal number of strands should be on each side of the peep before and after this adjustment.
- Compress bow in press, remove one end of the string from the cam and twist the string one or two turns as needed. Twisting the string from the top cam end will affect the peep position more than from the bottom end.
- If a string loop is used, wax the loop and the bow string serving where the loop is to be tied. This will prevent the loop from spinning on the string. The loop may then be rotated on the string to influence the position of the peep when the bow is drawn.

- If peep is off exactly 180 degrees, compress bow in press, remove peep, and place back in the string without changing any of the strands facing the opposite direction.
- If peep spins more than 180 degrees when bow is drawn, remove center serving of bowstring and reverse wrapping in the opposite direction.
- Install a peep sight with rubber tubing attached to it which is designed to turn the peep when the bow is drawn. If so, the rubber tubing must be regularly checked. For those that shoot regularly under strong sunlight, the tubing breaks a lot faster.

Methods for adjusting bow to sight in at long distances without placing the scope/sight pin in the path of the arrow or fletching.\*

- Reduce length of sight extension.
- Install scope with smaller diameter housing.
- Change point of release attachment from below the arrow to a loop attached above and below the arrow. This will cause the peep sight to be adjusted upward.
- Increase poundage/speed of bow within archer's ability.
- Reduce arrow weight within limitation of manufacturer's recommendation and tunability.
- Lower anchor point to increase peep height, which is an unpopular and critical change!

(\*) *After using any of these methods, adjust sight to the longest distance, place a small amount of lip stick or foot powder on the bottom of the scope or sight pin and shoot the bow. Inspect the arrow and the scope or sight pin for signs of contact after the shot.*

## 10. Maintenance

### *Maintenance suggestions*

Below are several suggestions for the care and maintenance of a compound bow.

Replace string and cables every year or two, or after 15,000 to 20,000 shots. If string or cables show signs of failure, replace immediately. String and cables should be replaced as a set. It is recommended to mark the cams against the limbs at brace position after the bow is set-in (cable and string fully stretched). If any of the marks moves from its original position, the bow must be checked.

Inspect the bow and accessories for wear or damage prior to shooting.

All bolts and screws must be retightened regularly.

Do not expose a compound bow to extreme heat. The string, cables, and limbs in particular can be damaged. This often occurs when a bow is left in a vehicle on a warm day.

After shooting in the rain, the bow should be left to dry under natural environment (in a ventilated and shaded place). Direct heating or sunlight is not recommended. The string and cable shall not be waxed until after moisture in them has evaporated. Waxing the string and cable when they are wet will trap the moisture. Axes and all moving parts (e.g. Arrow rest) should be checked and oiled

Lubricate the axles where they pass through the eccentrics approximately every 1500 to 2000 shots or at least once a month; lubricants should be based on silicone, Teflon or quality grease." with "dry-type Silicon or Teflon lubricants to avoid dirt from sticking to bow parts.

Bow string and cables should be waxed on a regular basis to protect them from abrasion, wear and separation.

Always have a qualified technician use a bow press that supports the riser of the bow in two places if the bow needs pressed.

For bows unused for long periods of time, it is recommended to reduce the draw weight to the minimum.



FITA  
Coach's  
Manual

**ARCHERS**  
**with**  
**DISABILITIES**  
Module

Intermediate  
Level



# FITA Coaching Manual

## Intermediate Level

### Module

## ARCHERS with DISABILITIES

### Contents

<i>Introduction (Disability Classes)</i> _____	2
<i>W2 Class</i> _____	2
<i>W1 Class</i> _____	3
<i>Standing Class</i> _____	4
<i>Visual Impair Class</i> _____	6
<i>Other issues</i> _____	10

### List of Acronyms

**FITA:** *Fédération Internationale de Tir à l'Arc*

**IPC:** *International Paralympic Committee*

### Introduction

**Quote** - *"I don't want to be considered as a disabled person who can take part in archery. I want to be considered as an Archer who happens to be disabled."*

The level one manual gave a general overview of the types of disability the coach might come across in their archers. This module is designed to give more detailed advice on assisting such archers. In particular, it will help the coach to develop the skills of those archers who may have aspirations to shoot for their country internationally. Currently, archers with a physical disability shoot internationally under the rules of the archery section of the International Paralympic Committee (IPC).

In 2004, FITA signed a memorandum of understanding with IPC so that the two organisations could cooperate on a number of levels. IPC Archery rules are basically the same as FITA rules with some changes to allow for difficulties which the archers may have. Archers with a visual impairment were also accepted as part of IPC Archery in October 2004. IPC divides archers into 3 classes for those with a physical disability according to their dis-

ability so that those with similar disabilities are shooting against each other. There is a separate class for the visually impaired (VI) archers. Consequently, this module is divided into 5 sections, one dealing with each class, and one which is generic. It is very important for the coach to find out the class of each archer as the rules of each class are slightly different. Advice on this can be sought from the IPC Archery Chief Classifier. Details of how to make contact will be found on the IPC website ([www.paralympic.org](http://www.paralympic.org)).

The main thing the coach has to remember about all these classes is that the shooting style is basically the same as for able-bodied archers, unless the archer lacks the use of the necessary muscles. It is, therefore, important to talk to the archer, in the first instance, to find out what they can and cannot do.

### Section 1 – W2 Class

The W2 class consists of archers who shoot from a wheelchair but, usually, have no disabilities in their upper body. Because of this, there is generally no problem with applying the normal coaching methods as the muscles used for archery are unlikely to be affected. However, the coach should always try to work so that they are on the same level as the archer rather than always towering over them as this can be intimidating. Most of these archers, particularly those with paraplegia, will have some difficulty with stability. It is, therefore, crucial that the coach spends time ensuring that the archer is getting the best possible support from the wheelchair. There are a number of points to bear in mind.

1. Make sure that the archer has applied both brakes so that the chair does not wobble when they are drawing the bow or releasing.
2. Check that the fabric of the back of the chair is not too taut. If there is some slack in the back of the chair, the archer can tuck himself back between the uprights and get some support from them to stop them falling sideways.
3. The cushion that the archer sits on has to be quite soft to prevent them from acquiring pressure sores. If the fabric below this has too much slack in it, this may prevent the archer from staying in a good upright position. A thin piece of board placed underneath the cushion can be of benefit.
4. Although IPC rules specify that the back of the wheelchair must not be too high, some archers have the back of the chair too low to give any support at all so this

needs to be checked and raised a little if required. In figure 1, the archer has the back of his chair well below the level required by IPC but at a reasonable height to give him some support.



*Height of back seat*

## Section 2 – W1 Class

The W1 class is also for archers who shoot from a wheelchair but who have additional disabilities in the arms and hands. IPC rules allow them to use compound bows in a separate class from that for Open Compound users but the bow must only have the same type of sighting arrangement as the recurve bow (i.e. no peep sight or magnifying sight). Even with a compound, many archers in this class cannot reach 90 meters so, in international competition, they only shoot the women's distances (i.e. 70/60 rather than 90/70). Compound bows in this class have a different weight restriction from that normally used in FITA. Men may only have a peak weight of 45 pounds and women 35 pounds. This is to make the class fair to those who are not capable of pulling the 60 pound maximum weight. All the information about wheelchairs in Section 1 is, of course, equally applicable to this class. The principle additional challenge faced by these archers is a lack of balance which could lead to them falling out of the chair on release. In order to avoid this, archers in this class are allowed, under IPC rules, to be strapped into the chair or use some kind of body support on the chair.

The next figure shows an archer wearing a strap which goes round his body and over one shoulder. What cannot be seen is that the strap goes right round the back of the chair.



The other problem for this class of archers is the small amount of mobility in the fingers. Usually, they cannot hold the string and must use some kind of release aid because they do not have sufficient use of the fingers to be able to hold the string. Most coaches will be familiar with the type of release aid used by compound archers, but these need more from the archer than is possible for a W1 archer so most will adapt the release aid according to the archer's needs. For some archers, the release aid needs to be attached firmly to the archer's hand so that they cannot be dropped on release. The next figure shows the archer attaching his release aid by means of a Velcro strap.



The next figure shows an archer at full draw and the tight strapping holding his release aid in place can be seen very clearly. This archer releases by turning his hand and the release aid has been specially adapted so that he can do this.





Some release aids have been made so that they will release when blown on. Others depend on the archer pressing them against some part of the face.



The more severely disabled in this class may also have an assistant to load the bow and make adjustments to the sight.



The archer may also have difficulty holding the bow so this may need to be strapped to their hand, either with an elastic bandage or by means of Velcro straps. Unlike an able-bodied archer, the archer will not be able to adjust this during shooting so the coach will need to keep a

check on it to make sure that the bow is in the optimum position.



### Section 3 – Standing Class

Surprisingly, in the Standing class, there are both standing and sitting archers. The thing that they all have in common is that their feet are on the ground, whereas wheelchair archers have their feet on the footplate of the chair.



The coach can do a little experiment for themselves to see how much more stability is gained by having the feet on the ground. Try shooting while sitting in a chair with your feet on the ground. Next, try this again but lifting your legs up so that they are stretched out in front of you,

unsupported, and you will get some idea of how unstable this makes you feel.

Those who use chairs do so because, although they can stand and walk, they do so only with difficulty, possibly needing crutches in order to maintain them self upright. They would be unable to stand whilst also shooting. IPC rules allow them to use any type of chair, although there is a limit to the amount of space the chair can occupy on the shooting line. However, they are not allowed to gain any support from the back of the chair so most use a stool without a back.

Choosing the right type of seat and deciding the best height for it are very important for ensuring that the archer has the best possible posture when shooting. On the next two views of the same archer, you can see that the stool is of a height which allows her to have her legs sloped downwards. A normal height chair would bend her legs up much more which would not be comfortable for her. She has also attached a cushion to the top of the stool which has been specially shaped, after much trial and error, to allow for the fact that she has more of a weakness on one side than the other.



Many of the archers in this class will have disabilities in the arms or hands and this can present more of a challenge to the coach as the solutions may require major alterations to the basic shooting style. If an archer has an arm missing, it may be the drawing arm or the arm which should hold the bow.

1. Bow arm missing. In this instance, the archer will use a prosthetic arm to hold the bow. This will need to be attached to the bow by some means and there are many different ways of doing this. The simplest is for it to be strapped to the bow by a bandage but many archers have developed quite hi-tech ways of doing this. The solution will depend very much on how much of the arm is still present. An arm that has been amputated below the elbow will allow the archer much more feeling of what the bow is doing than one which is amputated at the shoulder. There is no one solution and the coach will need to work with the archer in trying out various ways of addressing the problem until a satisfactory conclusion is reached.





*Weak bow arm mechanical assistance.*

2. Drawing arm missing. Most archers in this group choose to shoot by drawing the string with their teeth. A piece of leather is attached to the string in the same way as a D loop on a compound bow. The archer bites on the leather and pulls the string back with their teeth.



Have several spares handy as the leather is frequently bitten through. The technique used is quite different from that of most other archers as the bow arm is bent at the start of the draw and then gradually pushed forward as

there is obviously very little scope for the head to move backwards in the way that the drawing arm would. The muscles used to draw the bow are different from those normally used by archers and it is difficult for archers in this group to pull a heavy bow.



#### **Section 4 – Information for the participation by, and coaching of, visually impaired archers:**

##### ***Introduction***

The fourth section of this module is concerned with visually impaired (VI) archers. When coaching V.I. archers the main difference lies in the greater use of specialised equipment. Therefore this section will be divided into two parts. The first is dealing with, and showing the equipment which is specific to this disability. The second will cover some additional coaching aspects that are worth considering.

##### ***Basic VI shooting requirements***

Generally in archery two planes are required for accuracy. Elevation and direction. The bow sight provides a gauge for one of these to the mainstream archer having a method of allowing for elevation. Add its ability to allow for a limited amount of wind drift and it is a formidable tool. For direction the mainstream archer can use the shooting line and any other visual means to calculate the bodyline direction required to hit the target. However, for many of

the visually impaired these methods and devices are not normally available and other methods are required.

In Europe various methods are employed for initial teaching from the basic Italian method of guiding the archer by touch, the popular French electronic method using the ultrasonic transmitter / receiver pair and to the increasingly accepted combined method of 'tactile sight and foot locator'".

Using a visually impaired archer as a model the following photographs and descriptive text has been provided to allow you to understand the basic equipment developed for the last method.

It must be stressed that for an active VI archer to shoot and practice effectively they must make every effort to provide themselves with a 'helper'. The duty of this helper is to act as the eyes of the VI, providing guidance in defining the arrow strike, safety in and around all venues used by the VI archer and provides basic equipment maintenance unable to be performed by the VI archer.

### ***Introduction to the 'tactile' sight and 'foot locators'***

The tactile sight and foot locators allow the same assistance that a conventional sight has for the mainstream archer. The foot locators give an acceptable stance over the shooting line that is both comfortable and repeatable. When the foot locator positioning is completed the next step is to place the tactile device in place linking it in to the foot locators. It must be accepted here that foot locator styles and tactile supports vary in design so you may accept that the design shown is purely the preference of the 'model' archer.

### **STEP 1 – The tactile set-up for elevation and direction.**

We must start by developing 'line' or 'direction' for the VI archer and the first step towards this is the laying down of the foot locators by, in this case, the 'helper'. The foot locators initially will appear to be laid out pointing a little off centre as the V.I. archer will use the back of the bow hand as a reference and not a sight fitted to the bow riser.



### **STEP 2 – The next step is the addition of the tactile 'back of hand' sight that will allow for 'elevation'.**

The tactile stand shown here is a basic camera tri- pod. The tactile sight is fixed to the top and can be adjusted for elevation and windage. To prevent the tripod moving when the archer places sideward pressure onto the sight head the stand is pegged or weighted down.



In this example an elastic rope is pegged into the ground to provide the required stability. Next figure shows the tactile unit and foot locations before the preliminary adjustment is made for direction. It must be pointed out here that this tactile sight touches the back of the hand. Unlike the mainstream bow sight this device will give the impression that your archer will shoot left as the sight head is some seven to ten centimetres to the left of where the fixed bow sight would be. This photograph must be accepted as showing only preliminary setting and pegging.



The VI archer now has been provided with the two basic planes required to shoot with some degree of accuracy. The tactile sight head shown here has a spring-loaded button as a tactile point of contact. All tactiles of this style



require that they are spring loaded and in future international VI archery it will be mandatory that this style of tactile head be used. Next figure shows the final step of the preliminary set-up, which is the levelling of the tactile sighting head. This becomes particularly important outdoors where the ground is seldom level and caters for variables, which the tripod is unable to overcome.



With the VI. specific equipment now basically set up the time has come for the archer to take up position where the helper can view the set-up and correct any obvious errors in alignment. If all looks well at this point the equipment is ready for practice arrows to be shot. The ability of the VI's helper and archer to work as a team is important at this point as 'careless' set up will act only as a disincentive to the archer who relies heavily on the helper at this early stage.

The archer should now take up position in the foot markers. It is better, although unusual at first, for the archers to 'back into' the type of foot markers shown, as this has been found to provide a much more secure and duplicable stance.



The archer has now developed the basic line that should ensure the maximum chance of an initial hit on the boss once elevation is set up for the venue. The archer, using the back of the hand will position a knuckle joint on the ball of the tactile. Not all tactile sights use the ball but most VI archers find that it provides the most comfortable and accurate contact method between the sight and hand. Please note that it is illegal to position the ball BETWEEN the fingers as this can be interpreted as 'holding' the tactile. In this example the VI archer positions her feet to the right of the guides but this is personal preference and it is equally acceptable if the archer has both feet within or outside the guides. Although it is difficult to see in these photographs, the guides are adjustable.

The next figure demonstrates the common position of the tactile sight on the hand of the archer.



It may be noticed here that the clearance between any part of the bow and the tactile minimises the possibility of any contact between the two. The tactile in this example has all the adjustments that a mainstream sight would have. The ability for elevation is carried by the screw adjustment on the top of the sight and the 'windage' is taken up using the set-up screw on the left of the button carriage.

The next figure shows the detailed contact area.





The next figure shows the archer in position and shooting.



### *Coaching considerations*

With the exception of the sighting method used, both VI and mainstream archers should develop the same shooting skills and techniques. The exception for the VI archer is the ability to control body sway as it is quite possible that with little or no vision they will have difficulty detecting the sway before it becomes a source of lost points. Often, once attention is drawn to this and the archer is aware it is possible to correct. One thing to consider is the archer's footwear. Different types of shoes / boots can help to alleviate the problem and it is worth experimenting with different styles.

If the archer is a novice it will be advisable to work with them closely without the benefit of the tactile sight and foot locators in order to develop good basic skills as would be expected of any other archer.

Head position is as important to the visually impaired archer as any other, and the archer should be encouraged to develop good head positioning even though no vision is possible.

When the archer is introduced to the use of the tactile sight it is recommended that the archer be encouraged to come to full draw before contacting the tactile. It is all too easy for the archer to attempt to fit their stance to the tactile rather than use the tactile correctly.

Too much sideways hand pressure onto the tactile head may result in inconsistent arrow strike. The tactile sight must be spring-loaded which will magnify poor technique in the use of the sight.

On a technical issue, the archer may find difficulty in 'nocking' the arrow onto the string. This will be difficult not because the archer cannot see to do this but in detecting which way the 'cock' fletching is pointing.

The three next figures give some fletching variations that have been used successfully. Please note the 'four' fletched arrows. As many VI's shoot short distance rounds (30 meters) where the target face size is changed to simulate distance change, the four fletch arrow allows confident nocking point alignment as no 'cock' vane exists. The four fletch arrow displays good flight characteristics at these shorter distances.



Other methods of using conventional three fletch arrows exist, e.g. cutting a 'nick' in the cock vane.



Or, a mark can be made on the shaft near the nock with a 'blob' of glue or correction fluid.



Each method allows the archer to shoot with confidence.

We have mentioned the value of a dedicated 'helper' assisting the VI archer and also mentioned that most VI's do have some vision. For those VI's who have never had much vision from birth, or those who lost vision early in life, the concept of the 'boss' or the 'Target' may be difficult to imagine. For these archers a method of providing a sense of the accuracy of a hit may be more than the normal 'clock face / colour' description. 2 o'clock red may have much value to you or me, but not to a VI archer with little vision from birth. In these cases we need to

develop other methods of indicating accuracy without referring to the conventional method indicated above. These alternative systems may be simple or otherwise. For example, it may be sufficient to use the archer's hand as an indication of where the arrow strikes the target. The centre of the palm being the '10' and working out to the edges of the palm as the shot hits further out. Provided you have an agreement where 'top' is on the target and the hand, you have a method of representing a hit. You may also have a 'peg-board' option where the board has holes cut to indicate various parts of the target and a peg, or pegs, to indicate where the arrow strikes. The possibilities are numerous and only the desire to help is needed to arrive at a solution that is agreeable to the VI and those helping.

### **Section 5 – Other Issues:**

Sections 1 to 4 have given the coach some advice on the solutions to the major challenges that he will face when coaching archers with a disability. It is, however, far from a comprehensive guide as archers may have one or more of the disabilities discussed or other difficulties which may not have been mentioned. There are other points which need to be considered.

1. The archer's disability may cause him to tire more quickly than other archers. The coach should discuss this with the archer and bear it in mind when working out a training regime.
2. Tetraplegics cannot regulate their body temperatures in the same way as other people. This means that they do not sweat in hot temperatures and their extremities can become excessively cold in cold weather. The coach needs to keep an eye on this so that the archer does not get either heat stroke or hypothermia.
3. Many wheelchair archers are reluctant to keep up their fluid intake during events because of the difficulty of access of some toilet facilities. It is vital that they drink suitable quantities during the course of the day so the coach needs to ensure that they are aware of this and to encourage them to drink both water and sports drinks.

The important thing to remember is that archers with a disability will be as enthusiastic about and committed to their sport as any other archer. If the coach and archer work together to surmount any obstacles the archer has in achieving their potential, there are no limits to what can be achieved. So, don't be afraid to coach them and you will gain great satisfaction from their enjoyment of our sport.



FITA  
Coach's  
Manual

APPENDIX

**THE LINING UP OF A VISUALLY  
IMPAIRED ARCHER'S  
TACTILE SIGHT**

Module

Intermediate  
Level



## FITA Coaching Manual Intermediate Level

### Module

## THE LINING UP OF A VISUALLY IMPAIRED ARCHER'S TACTILE SIGHT

### Contents

<i>Introduction</i> _____	12
<i>Methods of line-up and aiming</i> _____	12
<i>Aligning the Archer's body</i> _____	14
<i>General information</i> _____	14
<i>Feet locator line-up</i> _____	14
<i>Tripod line-up</i> _____	15
<i>Tactile sight line-up</i> _____	16
<i>Getting tactile sight marks for shooting various distances</i> _____	17
<i>Getting Sighting Marks When The Ground Is Uneven</i> _____	18
<i>Quick reference guide</i> _____	20

### Introduction

The line up measurements and methods explained in this document may seem like a long winded task but once they are established and recorded the line-up procedure for a visually impaired archer will be quick and very accurate. This line up accuracy will be rewarded by finding the centre of the target within the first few arrows.

When a visually impaired archer's feet locators and tactile sight are being lined up ready for a training session or competition there are many areas that need considering to ensure that complete accuracy, when shooting, is achieved.

If the archer uses a tactile sighting aid on a tripod and the knuckle of the bow hand as the tactile sight contact point, the angles of the ground and vertical alignment of the body must be fully considered.

When shooting indoors the floor is flat, this is a constant that makes the visually impaired archer's task of be-

ing able to establish a constant stance and balance of the body relatively easy. But, when shooting outdoors this task can become quite a challenge when getting all the angles right to get the first arrow to land in, or, near to the gold.

When shooting outdoors, even though the field may seem flat, the ground at the shooting line may slope either upward or downward, even a slight slope will change the visually impaired archer's total line up and make their task a little more difficult when shooting. With consideration and the right tools, the task of total line up for the visually impaired archer can be relatively simple and very accurate.

### Methods of Line-Up and Aiming

For sighted archers there are three main types of shooting line-up, **Straight Line**, **Triangle** and **Quadrilateral**.

#### *Straight Line*

This is the simplest form where the fingers grip the string two or three inches below the arrow and when at full draw the archer looks along the arrow and aligns it with the required aiming point, making one simple in-line line-up point. See figure 1.



Figure 1

**Triangle**

This method needs a little more lining up when at full draw, as the string hand fingers are placed below the arrow on the string which are also used to locate the facial reference point at full draw. The eye lines up the point of the arrow with the required aiming point. This requires three line up points, the eye, arrow nock and the arrow point. String alignment is also required when using this method. See figure 2.



Figure 2.

**Quadrilateral**

this method is also known as the eye, sight, arrow relationship (ESAR) alignment procedure which introduces four line up points, the eye, arrow nock, sight ring and arrow point. String alignment is essential when using this method. This quadrilateral method is widely used and is a favourite with recurve freestyle archers. See figure 3.

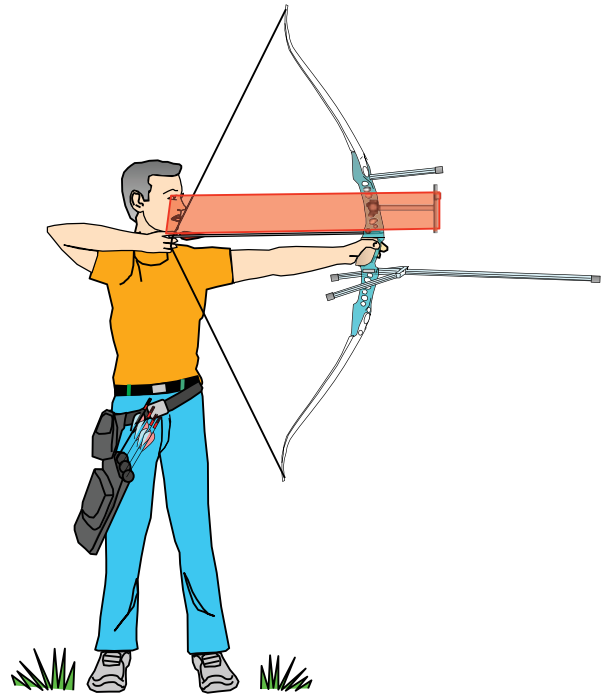

Figure 3.

With **visually impaired** archers there is another type of line up. This is also a **quadrilateral method** but the area of concern is **trapezoidal**, in this case the line-up points are; the facial reference point, the feet, the body alignment (in all planes) and the tactile sight (in all planes), using these reference points the area of alignment becomes much greater. Also, the angles become more critical when aligning up the tactile equipment and the archer who is to perform. See figure 4.

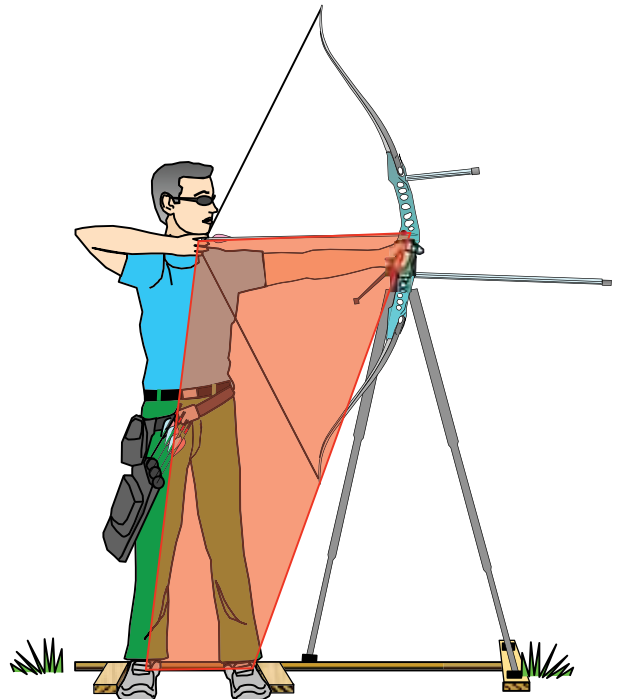

Figure 4.



## Aligning The Archer's Body

For an archer to stand erect and fully balanced many factors must be considered. Firstly, the shape of the archer's body is very important and a method of total balance must be determined.

If the archer is heavy in the frontal area i.e. has a large chest or paunch when standing upright the body will be leaning slightly back to compensate for this. Also, the head position will have an effect. With some people the head can be positioned to the front of the torso, this will also have a bearing on a balanced upright stance. There are several methods of determining an upright stance but here is one method used in field archery which is quick and effective:

- Have the archer stand as upright but comfortable as possible.
- Have them (keeping the body straight) lean back onto the heels until the toes want to lift off the ground.
- Then have them bring their body back to the upright position until the weight of the body is equally spread along the feet from the heels to the balls of the feet. This distance of movement at the chin may be anything from 3 to 5 inches (75 mm to 12.5 mm), which will depend on the size and shape of the body. See figure 5.

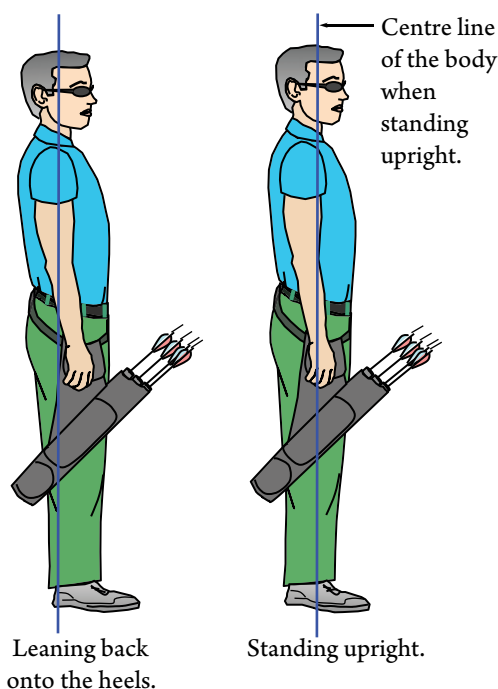

Figure 5.

With practice the archer can get very proficient at getting a constant balance which will enhance their chances of producing good form and performances.

## General Information

It is important that each individual archer's foot locator is set to the correct location. To do this there are some measurements that need to be established, these measurements will be personalised and different for each archer.

From here on each part of the archer's body and equipment will determine 'from where', 'to where', the measurements will be made. So, although each section of this document has its own heading, consideration must be given as each part of the equipment being used by individuals as it will have a bearing on these measurements, as will the archer's footwear.

Firstly we need to establish what kind of tactile sight is being used and the contact location point the archer favours.

In this explanation I will describe the use of a wooden foot locator and a tripod fitted with a ball and plunger type tactile device where contact is between the first and second knuckles on the bow hand. This position will give a more consistent line-up than having the contact point between the second and third or the third and fourth knuckles. The further the contact point is away from the first finger the greater the importance the angle of the bow hand becomes which will have an effect on the left/right accuracy.

It is advisable for the archer to wear the same footwear for each training session and competition. If different footwear is worn for training or competition the measurements and balance of the archer could be jeopardised.

## Feet Locator Line-Up

We need to establish how far the arrow line is forward of the body centre line when the archer is standing upright, fully balanced and at the full draw position. This measurement will be used as a baseline and must be as accurate as possible. See figure 6.

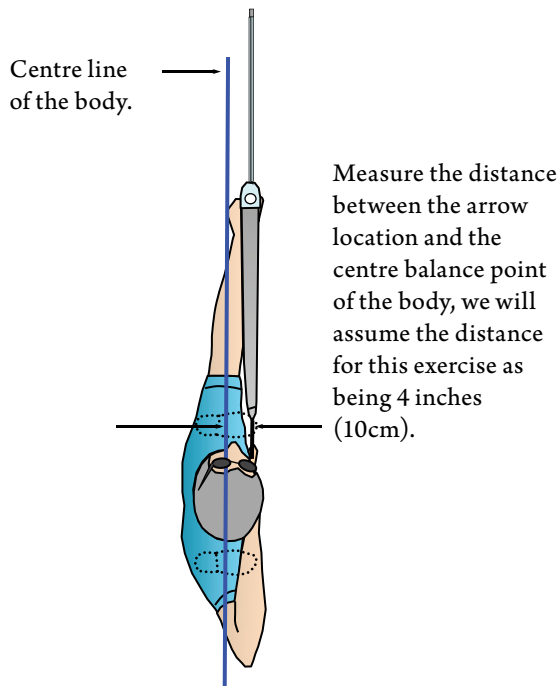

Figure 6.

This measurement of 4 inches (10cm) will be used to add to the measurement of the distance from the centre of the body to the back (heel) of the shoes being worn by the archer. For explanation of the set up we will give a measurement for this of 5 inches (12.5cm). This will give us a total measurement of 9 inches (22.5cm) that will be used to align the wooden feet locator to the centre of the target.

From the heel location of the feet locator measure 9 inches (22.5cm) along each of the feet side locators and drill a hole into which will fit a pencil, wooden dowel or similar. These two pencils/dowels can then be used to align the feet locator to the target. Once the feet location frame has been lined up the dowels should be removed. See figure 7.

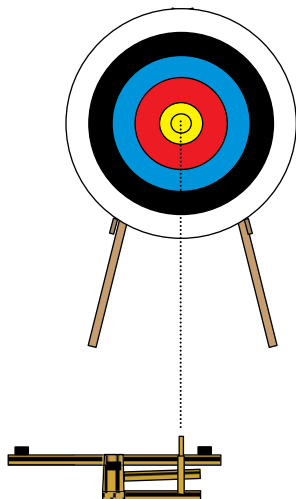

Figure 7.

When the archer is at full draw we need to establish the measurement from the tactile sight contact point on archer's hand to the centre of the arrow shaft when it is on the arrow rest. See figure 8.

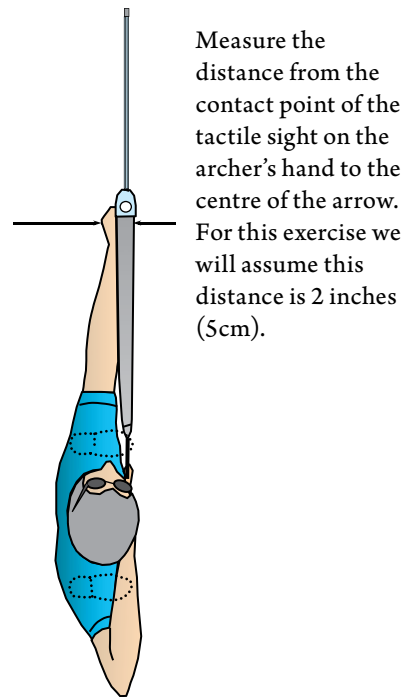

Figure 8.

**Tripod Line Up**

Once we have the feet location frame set correctly and the measurement established as in figure 8 we can introduce the tripod. With the tripod set vertically, and with the archer set correctly in the feet location frame, the pan head of the tripod should be in line with the bow hand knuckles when the archer is at the full draw position. See figure 9.

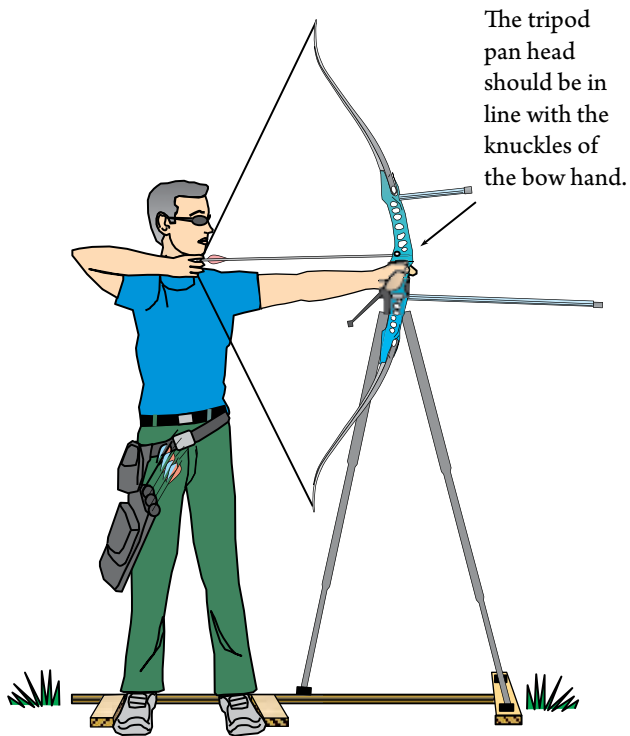

Figure 9.

### Tactile Sight Line-Up

With these measurements we can now establish a method of setting up the tripod which will help a quick and easy alignment of the tripod in the future. We can fix a piece of plywood to the feet locator in line vertically with the tripod pan head. See figure 10.

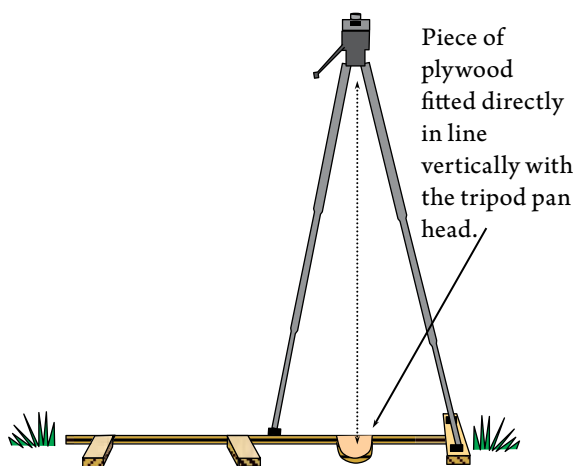

Figure 10.

When this piece of plywood has been fitted we need to refit the two pencils/dowels in the feet side locators. Fit the tactile sight to the tripod pan head so that there can be some movement for aligning the unit correctly. Hang a plumb line from the tactile sight plunger (the part that touches the bow hand knuckle). Look along the feet loca-

tor frame and align the two dowels on the feet locators and make mark on the piece of plywood in line with this line. Measure from this line inward toward the tripod the distance measured from the bow hand knuckle to the centre of the arrow i.e. as shown in figure 8 (2 inches / 5cm). Make a good visual sized dot (1/4 inch / 6mm) at this location. The tactile sight can now be lined up, move the tactile sight until the weight point of the plumb line fitted earlier is directly over the dot just made on the piece of plywood. See figures 11 & 12.

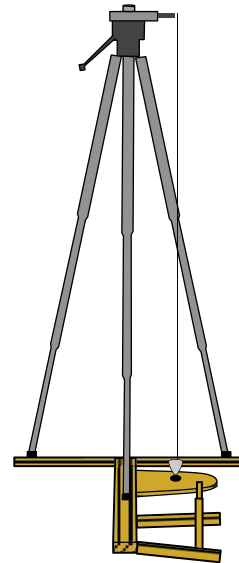

Figure 11.

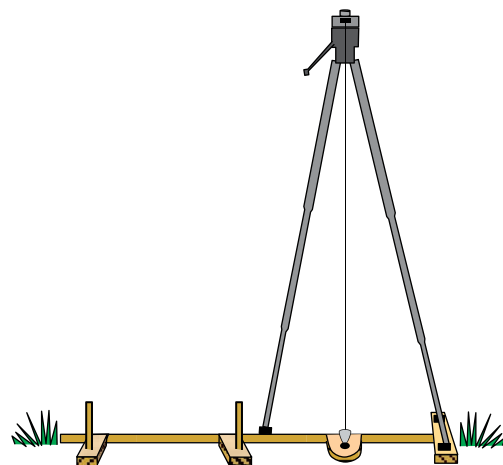

Figure 12.

With all these measurements/locations correctly lined up the archer should be able to stand in their shooting position, and shoot with their arrows going straight along this centre line to the centre of the target. See figure 13.



Figure 13.

- This procedure should also be carried out at a distance of 30 metres; **make sure that the ground is level all the way from the archers standing position to the target. If it is not the sighting mark being made on the dowel will not be correct.** See figure 13.

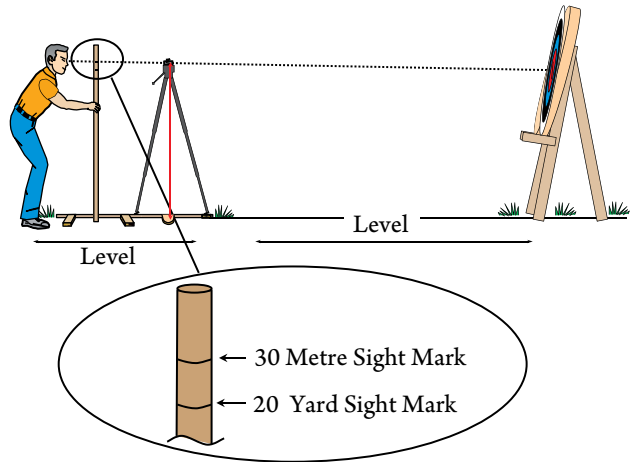

Figure 13.

### Getting Tactile Sight Marks For Shooting Various Distances

There is still another very important line up that needs to be done. We have lined up the archers apparatus to take care of any 'left & right' (horizontal) errors but we also need to take care of the 'up & down' (vertical) errors. It would be easier to achieve good results if the next set of adjustments could be determined when shooting indoors as the floor from the shooting line to the target is relatively flat.

- Set the feet locator and tripod etc. as mentioned above.
- Have the archer shoot at 20 yards (18 metres) to establish a height of the tactile sight where the archer's arrows are landing in the target at a height level with the centre of the gold.
- Have a piece of wood doweling which is as long as the archer's height. Place this vertically in the centre of the feet locators (where the archer stands).
- Look toward the target, line up the contact point of the tactile sight with the horizontal centre line of the target and make a mark on the dowel that is in line with these two locations. This will give a definite 20 yard (18 metre) 'sight mark' to adjust/line-up the height of the tactile sight to when shooting this distance in the future.

Now we have produced a dowel with the tactile sight marks clearly marked we can now set up the total 'shooting line-up' for our visually impaired archer even if the ground is sloping toward or away from the target. It must be remembered though that the archer **and** tripod must be vertical no matter which way the ground slopes. See figures 14, 15, 16 & 17.

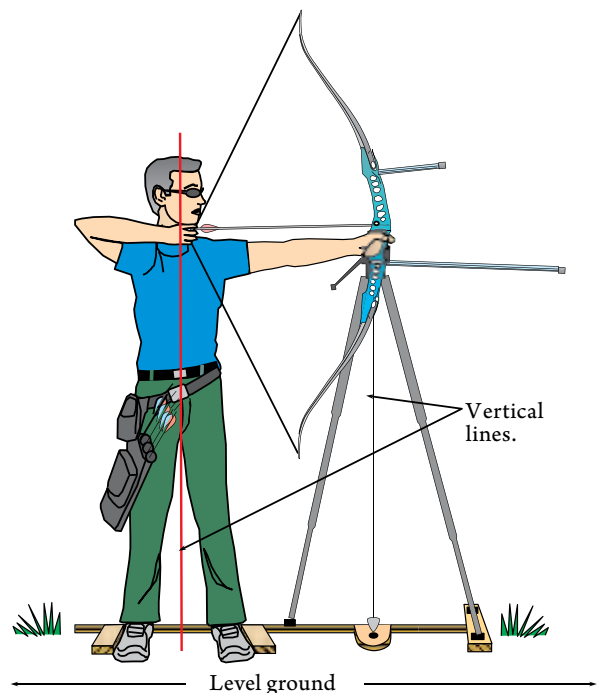

Figure 14.



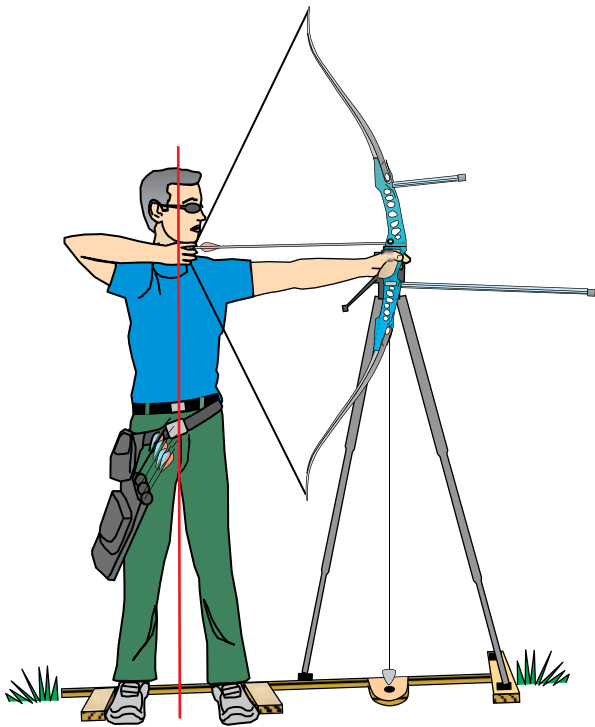

Figure 15.

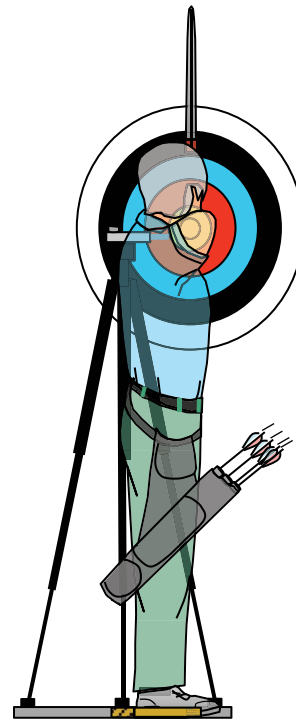

Figure 17.

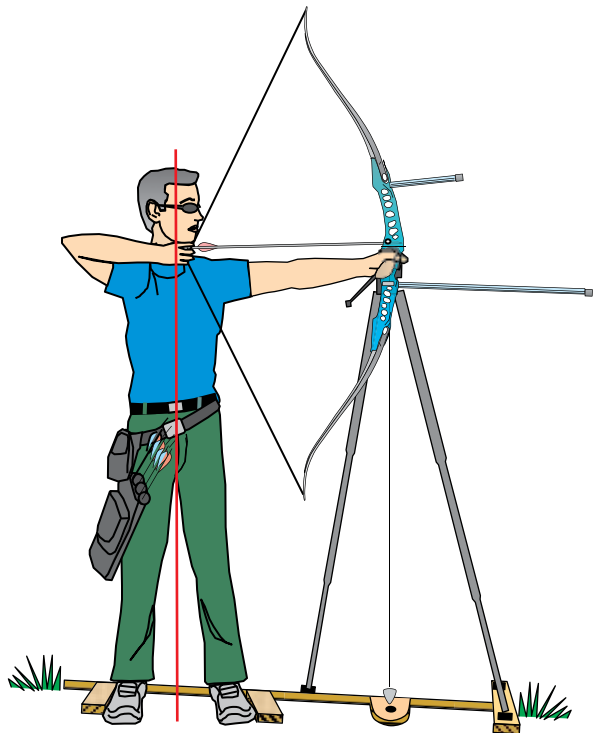

Figure 16.

Which ever the way the ground slopes the archer and tripod must be set vertical at all times.

### Getting Sighting Marks When The Ground Is Uneven

When shooting outdoors line up the feet locating frame and tripod in the manner discussed earlier. Make sure the tripod is vertical and the tactile sight hand contact point is directly over the spot on the piece of plywood previously fixed to the feet locating frame. See figure 18.

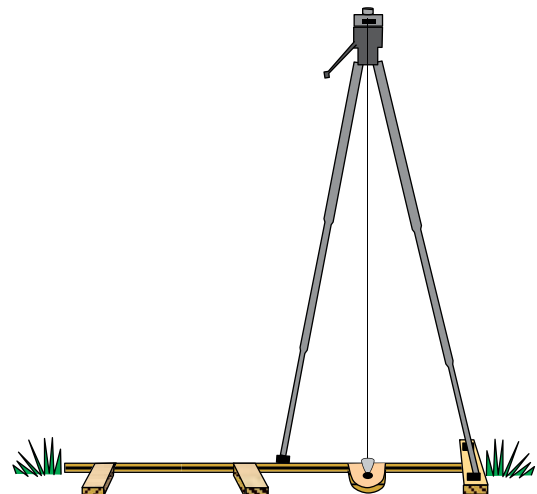

Figure 18.

The dowel made earlier which has the 20 yard (18 metre) and 30 metre sight marks on it can now be put to use. Place this sighting dowel between the feet locators and left of the aligning dowels (right handed archer) the same

distance that was measured from the bow hand knuckle to the arrow centre line when at full draw. Line up with the eye, the sight mark for the distance being shot and the centre of the target. Then adjust the height (only) of the tactile sight so that the part that touches the back of the bow hand is in line with the sight mark on the dowel and the centre of the target. This adjustment, if done correctly, will be correct no matter which way the ground slopes at the shooting line. See figures 19, 20, 21 & 22.

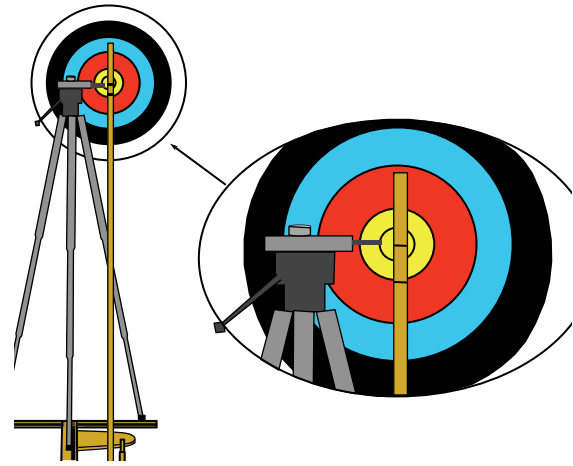

Figure 19.

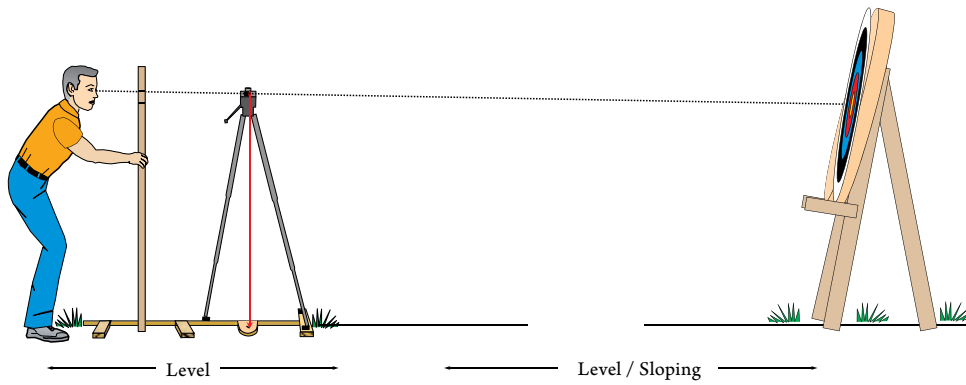

Figure 20.

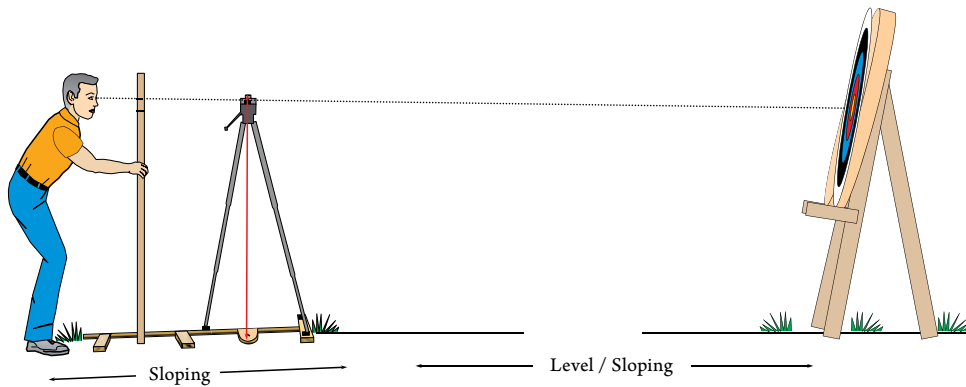

Figure 21.

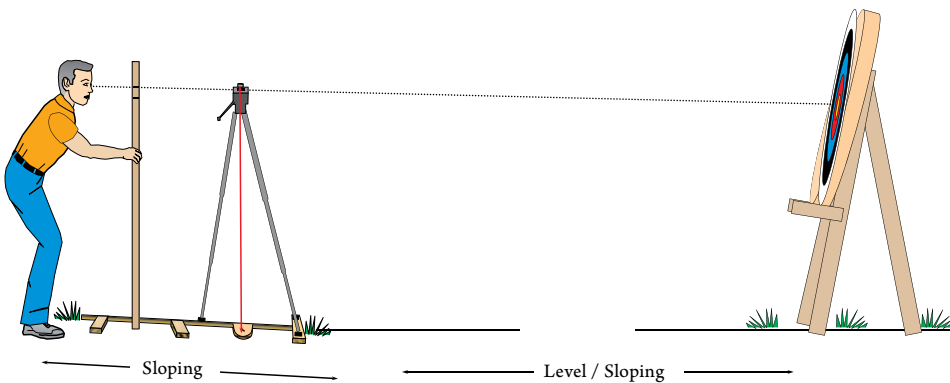
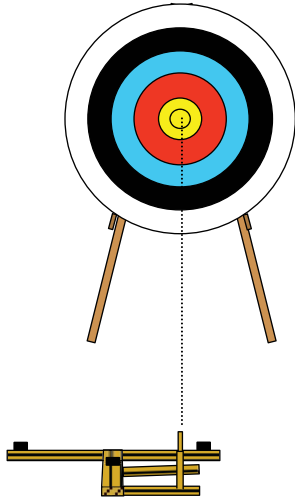

Figure 22.

When all of these adjustments have been made the set up is ready to be used.

### Quick Reference Guide

- Line up the feet location frame.



- Line up the tripod.

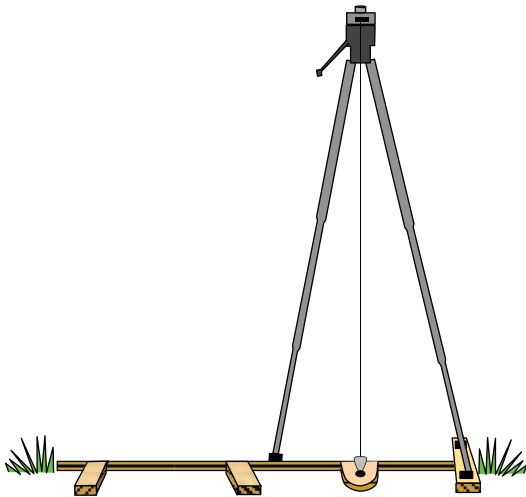

- Line up the tactile sight with the sighting mark on the sighting dowel and the centre of the target.

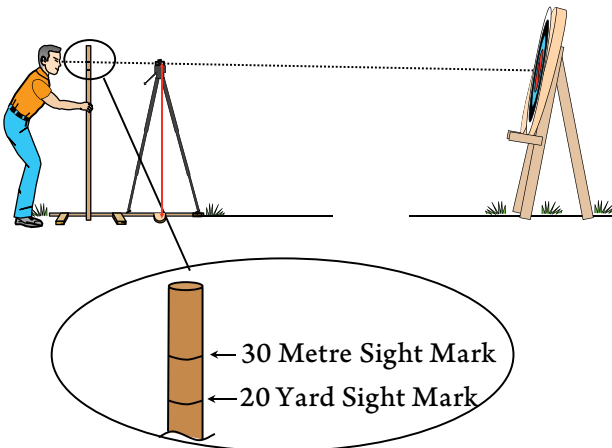

- Have the archer stand in the feet location frame, check they are standing upright and all the measurements previously taken are still correct for the archer.

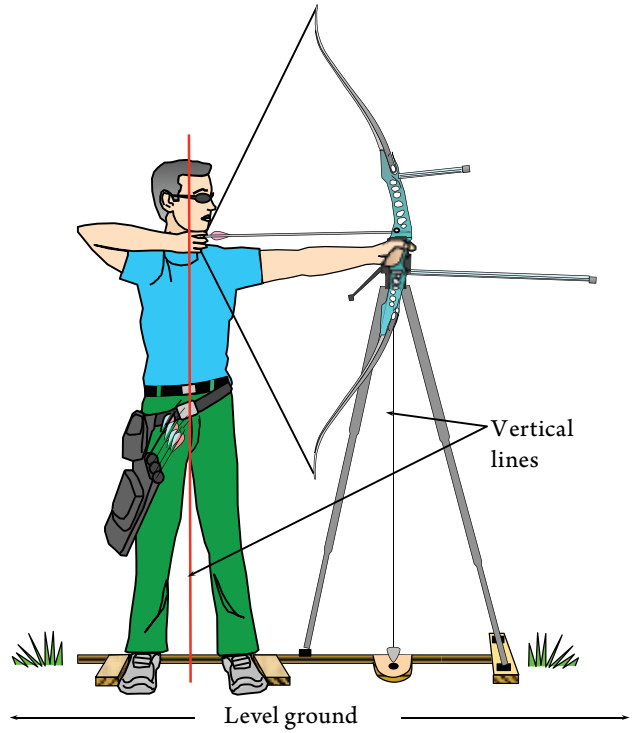

- Ensure the archer is upright and in line with the target.

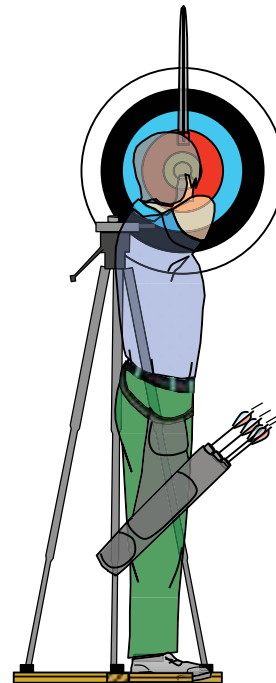



FITA  
Coach's  
Manual

**FIGHT against DOPING**  
Module

Intermediate  
Level





# FITA Coaching Manual

## Intermediate Level

### Module

## FIGHT against DOPING

### Contents

1. <i>Historic</i> _____	2
2. <i>Definition of doping</i> _____	2
3. <i>Prohibited Substances and methods</i> _____	3
4. <i>Therapeutic Use Exemption procedures</i> _____	6
5. <i>Doping Control Procedure</i> _____	7
6. <i>Useful links and information</i> _____	12

### Preamble

Coaching is about helping athletes to compete and perform to the best of their ability: If an athlete needs to take drugs to win, he is just not good enough. If a coach is caught endorsing the use of performance enhancing substances, he too is breaking the rules. This could affect his coaching career as well as bring shame on his sport and country.

UK Sport, which handles anti-doping programmes and policies in the UK, defines coaches' responsibilities in anti-doping matters as follows:

- Promote the ideal of doping-free sport to their athletes.
- Know how to access support and advice on doping-free sport.
- Help and encourage athletes to check all medication before use.
- Help athletes to understand the implications involved in taking supplementation and encourage athletes to seek advice about their health from a medical professional.
- Show concern and caution towards sick and injured athletes and develop positive strategies and support systems through injuries and illness.
- Understand the specific rules within their sport.
- Ensure athletes understand their rights and help them develop strategies for exercising their rights during the testing procedures.

- Ensure that a representative is available after each event to go to the doping control station with the athlete if selected for testing.

This chapter aims therefore to provide basic guidelines and information on what an anti-doping programme includes, as well as the latest anti-doping policies development within the framework of the new World Anti-Doping Code, and their consequences to the sport of archery.

### 1. Historic

At its 2003 Congress held in New York City in July 2003, FITA adopted the World Anti-Doping Code (“The Code”), developed by the World Anti-Doping Agency, which was established in 1999. This is the first document to harmonize regulations regarding anti-doping in sport across all sports and all countries of the world. The Code provides a framework for anti-doping policies, rules and regulations for sports organizations and public authorities.

Signatories to the Code had until the Summer Olympic Games in Athens in August 2004, to accept and implement the Code. This means that they must make sure that their own rules and policies are in compliance with the mandatory articles and other principles of the Code. Therefore new FITA Anti-Doping Rules, which came into effect as of 1 April 2004, have been adopted in conformance with FITA's responsibilities under the Code, and are in furtherance of FITA's continuing efforts to eradicate doping in the sport of archery. Indeed FITA has always been actively fighting against doping since and has been always at the forefront. FITA has been one of the first to test for alcohol in a systematic way. FITA in 1998 introduced Out of Competition testing and in 1999 was the first IF to have WADA conduct its Out of Competition testing.

### 2. Definition of Doping

Anti-Doping programs seek to preserve what is intrinsically valuable about sport. This intrinsic value is often referred to as “the spirit of sport”; it is the essence of Olympism; it is how we play true. The spirit of sport is the celebration of the human spirit, body and mind, and is characterized by the following values:

- Ethics, fair-play and honesty.
- Health.
- Excellence in performance.

- Character and education.
- Fun and joy.
- Team work.
- Dedication and commitment
- Respect for rules and laws.
- Respect for self and other participants.
- Courage.
- Community and solidarity.

Doping is fundamentally contrary to the “spirit of sport”. It is defined as the occurrence of one or more of the anti-doping rule violations.

The following constitutes anti-doping rule violations:

- The presence of a prohibited substance or its metabolites or markers in an athlete’s bodily specimen.
- Use or attempted use of a prohibited substance or a prohibited method.
- Refusing to submit to sample collection.
- Violation of availability for Out of Competition Testing.
- Tempering of Doping Control.
- Possession of prohibited substances and methods.
- Trafficking in any prohibited substance or prohibited method.
- Administration of a prohibited substance.

It is important to note that the four latter anti-doping rule violations are not only addressed to athletes (but also to any coach, trainer, manager, agent, team staff, official, medical or para-medical personnel working with or treating athletes participating in or preparing for sports competitions). In particular, those defined under the Code as “Athlete Support Personnel” should be concerned. In particular, “Possession of a Prohibited substance or method by Athlete Support personnel in connection with an Athlete, event or training, unless the Athlete Support Personnel establishes that the possession is pursuant to a Therapeutic Use Exemption granted to an Athlete, or other acceptable justification”, is an anti-doping rule violation. It is therefore strongly recommended, for example, that an Athlete Support Personnel under a personal medical treatment which includes a prohibited substance, should be able to provide, when on duty, his/her own medical prescriptions/certificates.

### 3. Prohibited Substances and Methods

FITA Anti-Doping rules incorporate the Prohibited List which is published and revised by WADA no less often

than annually (available on [www.wada-ama.org](http://www.wada-ama.org) and/or [www.archery.org](http://www.archery.org) under the link “anti-doping”). FITA makes the current Prohibited List available to each Member Association, and each Member Association shall ensure that the current Prohibited List in force is available to its members and constituents.

A substance or method shall be considered for inclusion on the Prohibited List if WADA determines that the substance or method meets any two of the following three criteria:

- Medical or other scientific evidence, pharmacological effect or experience that the substance or method has the potential to enhance or enhances sport performance.
- Medical or other scientific evidence, pharmacological effect, or experience that the use of the substance or method represents an actual or potential health risk to the athlete
- WADA’s determination that the use of the substance or method violates the spirit of sport as described above.

Below is a brief overview of the Prohibited Substances and Methods and their effects as per the List in force at 1 January 2007.

#### 3.1 Substances and Methods prohibited at all times (In- and Out-of-Competition)

##### *Anabolic Agents (Anabolic Androgenic Steroids–AAS) (S1):*

This class includes both exogenous and endogenous AAS. Where an AAS is capable of being produced endogenously, the deviation from the range of values normally found in humans is considered. For example, testosterone is a naturally occurring steroid hormone present in the body tissues of both males and females. It has both growth promoting (anabolic) and masculinizing (androgenic) properties. Women also produce testosterone but only one-tenth of the amount produced by men and most of it is converted to estrogens, the primary female sex hormone.

It is clear that women are more sensitive to testosterone than men and smaller doses are needed to enhance a woman’s performance.

Adverse effects of AAS include hair loss, oily skin, acne, deep voice, enlarged (males) or shrunken (females) breasts, psychiatric disturbances (aggressiveness), decreased sperm count (males), abnormal or absence of menstruation, re-

duced fertility and clitoral enlargement (females), enlarged prostate (males), hypertension, fluid accumulation and stunting of growth due to premature closure of epiphyses.

When testing for testosterone, the normal or average testosterone/epitestosterone (T:E) ratio in the urine is approximately 1:1. The T:E ratio greater than four (4) to one (1) in the urine is an Adverse Analytical Finding.

## **Hormones and related Substances (S2)**

### ***Erythropoietin (EPO)***

EPO is a substance which enhances the production of red blood cells to increase the oxygen content in the blood. It is a glycoprotein produced by kidney to regulate the production of red blood cells in the bone marrow. Red cells comprise around 42% of blood (haematocrit), the remainder being plasma. If haematocrit is high, EPO production is reduced. Recombinant EPO was produced in the late 1980's primarily to treat the anemia of renal failure. EPO enhances endurance performance in the same manner as blood doping. EPO is prohibited since 1990.

Adverse effects of erythropoietin include hypertension, thrombosis, iron deficiency, skin rash, a "flu-like" condition, palpitation, hypertensive encephalopathy and nausea.

### ***Growth hormone (Hgh) and Insuline-like Growth Factor (IGF-1)***

Human Growth Hormone is a natural hormone that stimulates growth, promotes protein synthesis and breaks down fat (lipolysis). HGH is prescribed for children or adults with growth hormone deficiency. Recombinant human growth hormone became available in the 1980's and its use prohibited since 1988.

Insuline-like growth factor is believed to increase the glycogen deposit in the muscle and increase lean body mass.

### ***Gonadotropins (hCG and LH)***

It is prohibited in males only, as it stimulates testosterone production. Chorionic Gonadotrophin (hCG) is a glycoprotein that is produced in large quantities in women soon after conception. It plays a vital role in maintaining a normal pregnancy. It has been used by males to stimulate testosterone production and to prevent the shutdown of testosterone and sperm production that accompanies long term use of AAS, therefore it is prohibited in males only.

The biological action of chorionic gonadotropin (hCG) are identical to those of luteinizing hormone

(LH) which is also involved in the regulation of testosterone production in men, therefore is also prohibited in males only.

### ***Corticotropins***

Corticotropins (ACTH, tetracosactide) have been misused to increase the blood levels of endogenous glucocorticosteroids, notably to obtain the euphoric effect of these drugs. The administration of ACTH or tetracosactide is considered equivalent to the oral, intramuscular or intravenous application of glucocorticosteroids.

### ***Beta 2-agonists (S3)***

Physicians prescribe Beta-2 agonists primarily for bronchospasm in asthma and other airways diseases. All Beta-2 agonists (including their D- and L-isomers) are prohibited except formoterol, salbutamol, salmeterol and terbutalin when administered by inhalation to treat asthma, which require a medical justification in accordance with the WADA International Standard for Therapeutic Use Exemption.

### ***Agents with anti-oestrogenic activity (S4)***

Aromatase inhibitors, Selective Estrogen Receptors Modulators such as tamoxifen, and other anti-estrogenic substances such as clomiphene and cyclofenil are prohibited.

### ***Diuretics and Masking agents (S5)***

Masking agents are products that have the potential to impair the excretion of Prohibited Substances, to conceal their presence in urine or other "Samples" used in doping control, or to change haematological parameters.

The main masking agents are Diuretics which increase the excretion of water and electrolytes (especially sodium and potassium) from the body via the kidneys.

Diuretics may be used by competitors for the two main reasons. Firstly, in weight classified sports to reduce weight rapidly. Secondly, athletes attempt to dilute urine, making it more difficult for laboratory to detect some prohibited substances that they have been using.

Adverse effects of diuretics include excessive weight loss, hypotension, low or high serum potassium, cardiac arrhythmia, muscle cramps, increased uric acid and possibly an attack of gout, reduced capacity for muscle function and death.

## Prohibited methods

### *Enhancement of oxygen transfer (M1)*

Blood doping and use of products that enhance the uptake, transport or delivery of oxygen (eg. Erythropoietin, perfluorochemicals, efaproxiral (RSR13), modified haemoglobin products) are prohibited.

### *Pharmacological, chemical and physical manipulation (M2)*

This consists in tampering, or attempting to tamper, in order to alter the integrity and validity of specimens collected during doping controls. This includes methods such as catheterisation, urine substitution and/or alteration, inhibition of renal excretion and alterations of testosterone and epitestosterone concentrations. Intravenous infusions are also prohibited.

### *Gene Doping (M3)*

Gene or cell doping is defined as the non-therapeutic use of genes, genetic elements and/or cells that have the capacity to enhance athletic performance.

## 3.2 Substances and Methods prohibited In-Competition only

### *Stimulants (S6)*

Mankind has used stimulants for thousands of years for their energizing properties. The early history of doping is dominated by reports of amphetamine, cocaine and strychnine incidents and later on of less potent stimulants such as ephedrine. These drugs are available either in foods and drinks or in over-the-counter (OTC) preparations.

The common feature of those substances is stimulation of the brain and all nerves of the body.

In high doses amphetamine disrupts co-ordination and produces aggressive behaviour, hallucinations, seizures, hypertension and cardiac arrhythmias. Long term use results in a tolerance and physical dependence.

### *Narcotics (S7)*

Among them is morphine which is a natural ingredient of opium. After processing, morphine can be converted to heroin, a highly addictive substance and a leading drug of abuse. Narcotics are widely used as analgesics (painkillers).

Several weaker narcotics are permitted including codeine, dextrapropoxyphene, pholcodine and tramadol. Those drugs are much less powerful than morphine and rarely lead to addiction.

The most serious side effects of powerful narcotics are due to physical dependence and the development of withdrawal symptoms. Heroin is the most addictive narcotic.

### *Cannabinoids (S8)*

Cannabinoids include both marijuana (the dried leaves and flowers of the Cannabis Sativa plant) and hashish (the dried resin extract from the leaves). In the sport of archery, due to their effects such as anxiety reduction and increase of self confidence, cannabinoids are considered to be performance-enhancers.

While cannabinoids are only tested in competition, the active substances are retained in fatty tissues within various organs of the body. Therefore, depending on the strength of the substance taken, the route of administration and the frequency of use, the metabolite may be detected in an athlete's urine sample for several weeks when used heavily and frequently, and for ten or more days after a single exposure. A concentration of THC (tetrahydrocannabinol) greater than 15 nanograms/ml constitutes an Adverse Analytical Finding.

### *Glucocorticosteroids (S9)*

Glucocorticosteroids are a class of drugs best known for their anti-inflammatory effects. They are widely used in medicine to reduce pain and inflammation associated with various joint and skin conditions. Glucocorticosteroids are invaluable to manage asthma and allergic disorders and diseases of the immune system.

Glucocorticosteroids are secreted by adrenal glands that regulate the metabolism of carbohydrates, proteins and fats.

However, use of glucocorticosteroids require medical control because they may cause severe side effects.

Recently, there has been a rise in non-therapeutic use of glucocorticosteroids by athletes during competition.

## 3.3 Other Substances prohibited in archery

On top of the above, FITA prohibits the use of the following substances.

### *Alcohol*

Alcohol in anything other than small quantities depresses brain function which reduces tension, inhibition and self control, increases confidence and the tendency to take a risk or actions. As alcohol consumption continues, judgment, co-ordination and reactions are increasingly impaired.



Competitors could misuse alcohol for psychological reasons such as to increase confidence or reduce pain. It is more commonly used to reduce stress/tension and hand tremor which would be beneficial in sports requiring accuracy such as bow shooting.

It can also increase self confidence resulting in an increased chance of taking a risk or acting in a way that competitor would not normally. This could put both the competitor and other competitors at risk.

The issue of alcohol misuse in sport is complex due to wide spread use (and abuse) of alcohol in the general community.

**Beta-Blockers**

Beta-blockers act by blocking the effect of natural stimulants (catecholamine) on the beta adrenergic receptors. These receptors are located in the heart, lungs and blood vessels. Beta-blockers were prohibited in 1985 because athletes used them for alleged medical reasons to enhance performance in shooting events. It is considered that beta-blockers enhance performance by reducing tremulousness, anxiety and tachycardia (fast heart rate) that athletes experience just before a competition. Conversely, beta-blockers impair performance in endurance events because they block the increase in heart rate and thus cardiac output necessary to perform to one’s maximum.

Adverse effect of beta-blockers include bradycardia (slow heart rate), inability to increase cardiac output when exercising, fatigue, depression and asthma.

In archery, the use of beta-blockers is prohibited in-competition and also out-of-competition,

**3.4 The case of nutritional supplements**

In order to meet the nutritional needs requested by their training regimen, many athletes use dietary/nutritional supplements. However there has been some evidence that some products may not contain the amount of ingredient listed on the label, may not contain the ingredient listed at all, or may be adulterated with other prohibited substances not listed on the label.

Doping control authorities can not judge intent. They can only judge what is found in the body, Ultimately, athletes are responsible for what they ingest, so it is possible that the use of some nutritional supplements could lead to an athlete being found guilty of a doping rule violation.

It is WADA’s and FITA’s position that taking a poorly labelled nutritional supplement should not be regarded

as an adequate defence in a doping hearing. Moreover, being concerned about inadequate labeling and insufficient quality control in the production of many nutritional supplements, WADA officially recommends not to take nutritional supplements.

**4. Therapeutic Use Exemption Procedures**

Athletes with a documented medical condition requiring the use of a prohibited substance or a prohibited method must first obtain a Therapeutic Use Exemption (TUE).

Exemption can be granted only in strict accordance with the following main criteria:

- the athlete would experience significant impairment to health if the prohibited substance or method were to be withheld in the course of treating an acute or chronic medical condition.
- the therapeutic use of the prohibited substance or method would produce no additional enhancement of performance other than that which might be anticipated by a return to a state of normal health following the treatment of a legitimate medical condition.
- there is no reasonable therapeutic alternative to the use of the otherwise prohibited substance or method
- an application for a TUE will not be considered for retroactive approval, except in cases where emergency treatment was necessary, or if, due to exceptional circumstances, there was insufficient time or opportunity for an applicant to submit an application prior to a doping control

Depending on the Athlete’s status the applications for a TUE are to be sent to FITA- or its partner service provider (the Swedish Testing Service Provider IDTM in 2007), or the National Anti-Doping Organisation (NADO) of the Athlete’s country. Below is a summary of the procedure in place in 2007:

Status of the Athlete	Criteria	Situation with regard to TUE application
International-Level Athlete	In the FITA Registered Testing Pool	To FITA/IDTM-mandatory
Athletes participating at FITA International Events	- Definition of an International Event (Book 1, Appendix 5 of FITA Rules) - FITA World Rankings	- To FITA /IDTM or - Mutual recognition policy with NADOs under certain conditions

Status of the Athlete	Criteria	Situation with regard to TUE application
Other Athletes	Not meeting the above criteria	<ul style="list-style-type: none"> <li>– NADO or</li> <li>– FITA/IDTM with the authorization of the Athlete's Member Association</li> </ul>

Except in emergency situation, no TUE application should be submitted to FITA later than 21 days prior to an athlete participation at an International Event.

International Standards for TUE are available on WADA's website [www.wada-ama.org](http://www.wada-ama.org) or FITA website [www.archery.org](http://www.archery.org).

Details on the current TUE procedure in place at FITA are available including FITA application forms on the FITA website [www.archery.org](http://www.archery.org) in the Anti-Doping / Therapeutic Use Exemption section. Information specific to national level procedures can be found at the NADO or, in the case there is no established NADO, at the National Olympic Committee (NOC) of each country.

WADA at the request of an athlete or its own initiation, may review the granting or denial of any TUE to an international level athlete or national level athlete that is included in a Registered Testing Pool.

If WADA determines that the granting or denial of TUE did not comply with the International Standard for Therapeutic Use Exemption in force at the time then WADA may reverse that decision.

Decision of TUE are subject to further appeal.

### **Abbreviated process**

It is acknowledged that some substances included on the List of prohibited substances are used to treat medical conditions frequently encountered in the athletes population. In such cases, a standard application is unnecessary. Accordingly an abbreviated process of TUE is established. However this process is strictly limited to the following:

- Beta 2 agonists (formoterol, salbutamol, salmeterol and terbutaline) by inhalation.
- Glucocorticosteroids with routes other than orally, rectally, intravenously and intramuscularly.

In addition, topical preparations when used for dermatological, auricular, nasal, ophthalmic, buccal, gingival and perianal disorders are not prohibited and do not require any form of TUE.

### **Checking medication**

It is of a prime importance that athletes check the ingredients in their medication to ensure it does not contain any substances that are prohibited in sport. Ignorance is no longer an excuse. The principle of "Strict liability" which prevails in the World Anti-Doping Code means that athletes are responsible for any substance found in their system despite how it came to be there.

## **5. Doping Control Procedure**

### **5.1 Preamble and principles**

All athletes affiliated with a Member Association shall be subject to In-Competition testing by FITA, the Athlete Member's association and any other Anti-Doping Organization (ADO) responsible for Testing at a competition or event in which they participate. All athletes affiliated with a Member Association shall also be subject to Out of Competition testing at any time or place, with or without advance notice by FITA, WADA, the athlete's Member Association, the National Anti-Doping organization of their country and any country where the athlete is present.

Testing shall be in conformity with the WADA International standards for Testing ([www.wada-ama.org](http://www.wada-ama.org))

Anti-doping tests are an accepted and necessary part of competitive sport. Coaches and support personnel should understand and value the purpose of a doping control programme, and should encourage athletes to promote themselves as drug-free by making themselves available for testing. Coaches should be aware of the services available and they should understand how to access and interpret information given so as to guide athletes appropriately on issues of doping-free sport.

### **5.2 Doping control procedure includes the following**

#### **5.2.1. Selection and notification**

##### **Selection**

At FITA Events the number of tests will be determined by the FITA Medical Committee in cooperation with the Organizing Committee.

- World Indoor and Outdoor Target include a minimum of 35 tests
- World Junior Outdoor Target, World Field include a minimum of 15 tests.
- World Championships of other disciplines include a minimum of 5 tests

- At Continental Qualification Tournaments for the Olympic Games number of tests included at the minimum all athletes who obtain quota places.
- World Ranking Tournaments include a minimum of 6 tests

At Continental Championships, each Continental Association shall determine the number of athletes selected for testing and submit their plans to the FITA Medical Committee for approval

At national events, each Member Association shall determine the number of athletes selected for testing in each competition and the procedures for selecting the athletes for testing.

In addition to the selection procedure at events, the FITA Medical Committee at International events and the Member association at national events may also select athlete for target testing (see also item 5.2.8)

### **Notification**

A Doping Control Officer (DCO) will notify the athlete of a selection for a test and the requirements to provide a urine sample. Athletes will also be informed of their rights and responsibilities regarding doping control, including the right to have a representative present, and the responsibility to remain within sight of a chaperone or the DCO at all times until the completion of the sample collection process. Athletes will be requested to sign the notification form. At events athletes must comply with the sample collection within one hour following notification.

#### **5.2.2. Sample taking procedure:**

This takes place at a doping control station which, at a minimum, ensures the athlete's privacy and is used solely as a doping control station for the duration of the sample collection session.

### **Collection vessel selection**

When athlete is ready to provide a urine sample, he/she will select an individually sealed collection vessel.

### **Provision of a urine sample**



Athlete will provide a urine sample of approximately 100 ml in unobstructed view of the chaperone/DCO of the same gender of the athlete. If the athlete gives an insufficient sample (less than 75 ml), the sample provided will be securely sealed in a partial sample container until the athlete is ready to provide an additional quantity of urine.

The DCO will check the (pH) and concentration (specific gravity) of the athlete's sample to ensure it is suitable for analysis. If it is not suitable for analysis, the athlete will be asked to provide another sample.

### **Pre-packaged kit selection**

The DCO will ask the athlete to select a pre-packaged kit which will be used to contain, identify and secure the urine sample. The athlete will be asked to verify that the ID numbers on the secure transport containers and sample bottles are consistent. The DCO will write these numbers on the Doping Control Form.

### **Urine Sample Division and Packaging**

The athlete will divide the sample into the "A" and "B" bottles,



and screw the bottle tops securely.



Finally, the athlete will seal the bottles in the secure transport containers,



and ensure that the sample numbers are recorded on the Doping Control Form.

### ***Recording of substances taken***

The DCO will ask the athlete to identify what prescription/non prescription drugs, vitamins, minerals and supplements he has taken, and this information will be recorded on the Doping Control Form.



*The 5 above pictures are courtesy of  
Swiss Federal Office for Sport*

### ***Completion of the Doping Control Form***

Athlete will ensure recorded information is accurate and complete, and will be able to provide comments. The Doping Control Form will be signed by all parties and the athlete will receive a copy for his/her own records.



### ***Alcohol tests***

Alcohol (ethanol) is prohibited by FITA in Competition only. Alcohol should not be consumed before or during competition.

The alcohol test is performed by the testing of expired air. In FITA events athletes selected for urine samples will also be tested for alcohol, but additional tests may be carried out at the discretion of the DCO.

The athlete will be requested to select an alcometer for breath analysis.



If the test of expired air exceeds the equivalent of a blood alcohol concentration of 0.1 promille (parts per thousand), a second test of expired air will be performed 10 minutes later using a different alcometer.





If the second test of expired air still exceeds a reading equivalent to a blood alcohol concentration of 0.1 promille (parts per thousand), this will result with an Adverse Analytical Finding.

### 5.2.3. Analysis of sample

Urine samples will be sent by secure courier to a WADA accredited laboratory, the chain of custody being documented at every stage of the process. The laboratory will analyze the content of the “A” bottle for the presence of prohibited substance or methods, and the “B” bottle is securely stored.

Laboratories shall analyze doping control samples and reports results in conformity with the International Standards for Laboratory Analysis ([www.wada-ama.org](http://www.wada-ama.org)).

### 5.2.4. Test result management

Results will be sent to FITA, WADA, Athlete Member Association and/or National Anti-doping Organization, depending on which Anti-Doping Organization (ADO) has initiated the test. Athlete is notified only if the “A” sample returns an Adverse Analytical Finding.

All communication must be conducted in such a way that the results of the analyses are confidential.

Upon receipt of an “A” sample adverse analytical finding, the ADO anti-doping administrator shall conduct a review whether (a) an applicable TUE has been granted, or (b) there is any apparent departure from the International Standards for Testing or Laboratory analysis that undermine the validity of the Adverse Analytical Finding.

If this is not the case, the ADO shall promptly notify the athlete of the adverse analytical finding, the anti-doping rule violation, and his/her right to promptly request the analysis of the “B” sample, or, failing such request, that the “B” sample analysis may be deemed waived. Ar-

rangements for testing the “B” sample shall be made within three weeks of the notification. If the “B” sample proves negative, the entire test shall be considered negative.

Conclusions of a FITA member Association’s results management process shall be reported to FITA within 14 days.

### *Provisional suspensions*

ADOs may provisionally suspend an athlete prior to the opportunity for a full hearing based on an Adverse analytical finding from the athlete “A” or “A” and “B” samples.

In case of an Adverse Analytical Finding with alcohol, the athlete will be withdrawn from the competition.

International Standards for Testing are available on WADA’s website [www.wada-ama.org](http://www.wada-ama.org), and also on the FITA website under the link “Anti-Doping”.

### 5.2.6. Disciplinary procedures:

All hearings shall respect the following principles:

- A timely hearing.
- Fair and impartial hearing body.
- The right to be represented by counsel.
- The right to be fairly and timely informed of the asserted anti-doping rule violation.
- The right to respond to the asserted anti-doping rule violation and resulting consequences.
- The right to each party to present evidence, including the right to call and question witnesses.
- The right to an interpreter at the hearing.
- A timely, written, reasoned decision.

ADO shall appoint a disciplinary body which should include a lawyer.

At international level, the Member Association of the athlete may attend the hearing as an observer. Hearings shall be completed expeditiously following the completion of the results management process. Decisions may be appealed to Court of Arbitration for Sport.

At National level, hearings shall be completed within three months of the completion of the results management process. If the completion of the hearing is delayed beyond three months, FITA may elect to bring the case directly before its own anti-doping panel. Member associations shall keep FITA and WADA fully apprised as to the status of pending cases and the results of all hearings. FITA and WADA shall have the right to attend hearings



as an observer. Decisions may be appealed to a national-level reviewing body.

#### 5.2.7. *Sanctions*

In case of violation of the anti-doping rules there will be disqualifications of different extent, depending on the kind of violation.

- Disqualification of Results in events during which an anti-doping rule violation occurs
- Imposition of ineligibility for prohibited substances and methods.
- First violation: two years' ineligibility.
- Second violation: Lifetime ineligibility.

#### *Specified substances*

The prohibited list may identify specified substances which are particularly susceptible to unintentional anti-doping rules violations because of their general availability in medicinal products or which are less likely to be successfully abused as doping agents. A doping violation involving such substances may result in a reduced sanction provided that the athlete can establish that the use of such a specified substance was not intended to enhance sport performance.

- Ineligibility for other anti-doping rules violation.

An anti-doping rule violation involving a Minor shall be considered a particularly serious violation, and, if committed by Athlete Support Personnel for violations other than specified substances shall result in lifetime ineligibility for such athlete support personnel.

- Exceptional circumstances.

If an athlete establishes that he or she bears no fault or no significant fault or negligence, the period of ineligibility may be eliminated or reduced.

The ADO may reduce a period of ineligibility in cases where the athlete has provided substantial assistance which results in discovering or establishing an anti-doping rule violation by another person involving possession, trafficking or administration to the athlete.

The period of ineligibility shall start on the date of the hearing decision providing for ineligibility. When required by fairness, the period of ineligibility may start at an earlier date commencing as early as the date of sample collection.

#### *Consequences to teams*

If a member of a team is found to have committed an anti-doping rule violation during an event, the team shall be disqualified from the event.

#### 5.2.8. *Out of competition Doping controls*

Out of competition testing programmes aim to uphold the fundamental right to athletes to participate in doping free sport through effective detection and deterrence. Such a programme protects the majority of athletes who choose to compete in a spirit of fair-play.

Athletes can be selected for doping control at any time, anywhere.

ADOs have a registered testing pool of those athletes who are required to provide up-to-date whereabouts information. Each athlete in a registered testing pool shall file regular reports which specify on a daily basis the locations and times where the athlete will be residing, training and competing. Each member association shall use its best efforts in obtaining whereabouts information for its athlete within the FITA International International testing pool, and for their national teams training camps/competition programmes. Each Member Association shall also assist the National Anti-Doping Organization in establishing a national level registered testing pool of top level national athletes who are not already included in the FITA International testing pool.

The ADO will then establish a test distribution planning and shall ensure that athlete support personnel shall not be involved in the test distribution planning for their athletes. Athletes shall be selected using target testing (eg injury, withdrawal or absence from expected competition, behaviour indicating doping, sport performance history, reinstatement after a period of ineligibility, etc...), weighted and random selection methods.

Since 2006 FITA uses the online Anti-Doping Administration Management System ADAMS which was developed by WADA in order to assist ADOs in managing their anti-doping programmes. FITA encourages all its Member Associations and Athletes involved in a Registered Testing Pool to use this system as well. For example, as of January 2007, FITA has made the use of ADAMS mandatory for all its RTP athletes who shall provide whereabouts information. Full details on ADAMS can be found on [www.wada-ama.org](http://www.wada-ama.org).

## 6. Useful Links and References

Please note that this list is not exhaustive

- World Anti-Doping Agency:

[www.wada-ama.org](http://www.wada-ama.org)

from the WADA website at the bottom of the home page a Links section can be downloaded, which includes access to National Anti-Doping Agencies cooperating with WADA.

WADA has implemented lots of information and education tools that can be useful for coaches, many available in different languages. From its website home page there is access to:

- *the Level the Playing Field Video*: a brief video promoting the virtues of Clean Sport from the perspective of the Clean Athlete.
- *The Resources*, which includes:
  - **Athlete Guide**: This booklet provides an overview of the Code, and includes athlete rights and responsibilities relating to the doping control process.
  - **Q&A on TUEs**: This leaflet explains the Therapeutic Use Exemption (TUE) process and the athlete's responsibility in relation to TUEs.
  - **Doping Control Video**: Available in five different languages, the video demonstrates the process for in- and out-of-competition.
  - **Doping Control Leaflet**: This leaflet provides a step-by-step description of the doping control process so that athletes understand their rights and responsibilities during testing.
  - **Q&A on Athletes and Medications**: This leaflet highlights issues relating to taking prescription and

over-the-counter medications as they relate to the fight against doping in sport.

- **The Digital Library**: a global clearinghouse of currently available informational and educational anti-doping material created by stakeholders.
- *The Programme/Education section* which includes the Coaches' Tool Kit, elaborated by WADA in March 2007. It contains a ready-to-deliver doping prevention workshop for elite coaches. The modular format of the workshop offers a core 3-hour training program that can be extended up to a full day with the inclusion of 'à la carte' optional modules.



- FITA: [www.archery.org](http://www.archery.org) ("Anti-Doping" link)
- YAADIS (Young Athletes Against Doping in Sport): [www.yaadis.com](http://www.yaadis.com)
- [www.dopage.com](http://www.dopage.com): (a very well documented website in French)



FITA  
Coach's  
Manual

**FIELD ARCHERY**

Module

Intermediate  
Level



# FITA Coaching Manual

## Intermediate Level

### Module

### FIELD ARCHERY

### Contents

<b>Chapter 1. Introduction</b> _____	3	<i>indoor sessions</i> _____	23
<i>Field archery round</i> _____	4	<i>Indoor facilities for instruction</i> _____	25
• Individual event		<i>Training for reliable sight marks</i> _____	25
• Team event		<i>Practicing on site</i> _____	26
• Scoring		<i>Shooting across a slope</i> _____	26
• Forest round		<i>Summary of conclusions for training</i>	
• Scoring		<i>in Field Archery</i> _____	28
• FITA 3D Animal round			
• Scoring			
• 3DI round			
• Scoring			
<b>Chapter 2. Equipment</b> _____	10	<b>Chapter 6. Personal Care</b> _____	30
<i>Equipment</i> _____	10	<i>Footwear</i> _____	30
• Sight		<i>Clothing in cold weather</i> _____	30
• Tuning		<i>Clothing in hot weather</i> _____	31
		<i>Clothing in wet weather</i> _____	31
		<i>Binoculars</i> _____	31
		<i>Backpack or belt</i> _____	32
		<i>Spare parts</i> _____	32
		<i>Nutrition</i> _____	32
<b>Chapter 3. Range Finding</b> _____	11	<b>Chapter 7. Safety in Field Archery</b> _____	33
<i>Practice exercises for range finding</i> _____	11	<i>Planning</i> _____	33
<i>Range finding with sight</i> _____	16	<i>Facilities</i> _____	33
<i>Range Finding for Forest and</i>		<i>Emergency action plan</i> _____	34
<i>3D Animal rounds</i> _____	17	<i>Individual Safety</i> _____	34
		<i>Group safety</i> _____	34
		<i>Personal protective clothing</i> _____	35
		<i>First aid</i> _____	35
		<i>Directional signs</i> _____	35
		<i>Lost arrows</i> _____	35
<b>Chapter 4. Uphill and Downhill Shooting</b> _____	18	<b>Chapter 8. Tactical Considerations in</b>	
<i>Posture for shooting uphill with level</i>		<b>Field Archery</b> _____	36
<i>feet position</i> _____	19	<b>What do I need for a Field Shoot?</b> _____	36
<i>Posture for shooting downhill with</i>		<i>Specific Field Archery awareness and</i>	
<i>level feet position</i> _____	19	<i>considerations</i> _____	36
<i>Posture for shooting uphill on</i>		<i>Preparations for the field rounds before the</i>	
<i>sloping ground</i> _____	20	<i>opening of the Field season</i> _____	36
<i>Posture for shooting downhill on</i>		<i>Tips for the Coach</i> _____	36
<i>sloping ground</i> _____	20		
<b>Chapter 5. Training for Field Archery</b> _____	21		
<i>Organisation preparation for</i>			
<i>outdoor practice</i> _____	21		
<i>Facility</i> _____	21		
<i>Tips for preparing the practice site</i> _____	22		
<i>Indoor or off-season training</i> _____	23		
<i>Practice training tips for the off-season</i>			

## Chapter 1. Introduction

The topic of this module is archery on course, which includes the following disciplines in field archery: Field, Forest, 3D and 3DI. All these field archery rounds practice archery in natural surroundings. Shooting in the forest, uphill and downhill in the mountains, over lakes and slopes and with all kind of natural barriers is part of the game of archery on course.

According to the type of bow that is utilized, we distinguish for each discipline the following equipment divisions:

### *The compound bow*



For compound bows a mechanical release and scope are allowed as in target archery.

### **The Recurve bow**



A Recurve bow in field archery is the same as in target archery.

### **The Bare bow**



A bare bow looks like a Recurve bow but without a sight or stabilizers. Different aiming techniques are practised in the bare bow division, using for instance the point of the arrow or the arrow rest for aiming. The bare bow archer will vary the position of the nock of the arrow in relation to his aiming eye, most probably by practicing 'string walk', using different positions on the string for the fingers of the draw hand, or by using different anchor points, 'face walk', or a combination of both in order to make it possible to aim in the middle of the target at different distances.

### *The Longbow and Traditional bows*





Longbow and traditional archers shoot the simplest of all bows, with wooden arrow shafts and natural feather fletching. They practice the so called 'instinctive' style of shooting. Howard Hill, one of the best instinctive archers ever, described his way of aiming as 'split vision' or secondary aiming. If you point with your index finger towards a target and keep focused on the target with your eyes, you can move your finger up and down but you still will see it in your range of vision, be it blurred.

There are, on a national level, more disciplines such as the Recurve or Freestyle unlimited, Compound limited and unlimited, as well as different Bow Hunter styles.



Each time when shooting at a given distance, notice where in your range of vision, your finger can still be seen. Remember this and practice as often as possible on different distances and different objects. This is in a way subconscious 'gap shooting' which is aiming high or low to compensate for the distance.

Shooting field archery with a recurve or compound bow is basically the same as shooting target archery and some good target archers became a good field archer. There are however a lot of characteristics in field archery, that are unknown in target archery:

Shooting takes place in natural surrounding (forest, hills, etc.).

The archer has to shoot uphill and downhill and must know by experience how much to subtract from or add to the (estimated) distance to aim correct and hit the target.

The archer has to shoot at targets that are not perpendicular to the aiming line, which gives specific results if missing the centre of the spot (the highest scoring point on the target).

The archer has to recognize different target faces and has to estimate their position in the field.

There is no direct visibility of most of the competitors, the scoring of competitors during the course is unknown.

### ***Field archery round***

There are 24 targets to be shot by each archer. The targets are of different size and at different moderate shooting distances spread over the area. The archers go round the course in groups of four.



A morning assembly of all participants, one of the organizers will act as an escort to take each group to their first target in the field. The thrill of encountering new shooting conditions is typical for a field archery round.



A shooting position in the field is marked with a wooden peg at some distance from the target. The Recurve and the Compound divisions shoot from the red pegs, the Bare Bow, Cadet Recurve and Cadet Compound divisions shoot from blue pegs and the Cadet Bare Bow division shoots from yellow pegs.



In field archery we use four different sizes of target faces; the distance being shot determines the size. Each target has one 80 cm or 60 cm face or four 40 cm faces or twelve 20 cm faces, ordered in a (3x4) matrix.



**Individual event**

An individual Field archery round consists of a Qualification Round followed by two Elimination Rounds and two Final Rounds.

The Qualification Round consists of two courses of 24 targets each:

- One marked.

**A Unit for a Marked Course**

Number of Targets	Diameter of Field Faces in cm	Distances in Meters		
		Yellow Peg Cadet Barebow	Blue Peg Barebow, Cadet Recurve, Cadet Compound	Red Peg Recurve and Compound
3	Ø 20	5-10-15	5-10-15	10-15-20
3	Ø 40	10-15-20	15-20-25	20-25-30
3	Ø 60	20-25-30	30-35-40	35-40-45
3	Ø 80	30-35-40	40-45-50	50-55-60

Where more than 12 targets are required for a Unit, additional targets may be added in multiples of 4.

- One unmarked.

**A Unit for an Unmarked Course**

Number of Targets	Diameter of Field Faces in cm	Distances in Meters		
		Yellow Peg Cadet Barebow	Blue Peg Barebow, Cadet Recurve, Cadet Compound	Red Peg Recurve and Compound
3	Ø 20	5-10	5-10	10-15
3	Ø 40	10-15	10-20	15-25
3	Ø 60	15-25	15-30	20-35
3	Ø 80	32-35	30-45	35-55

A Combination Round is where a Unit of Unmarked distances and a Unit of Marked distances are combined to make a single Round.

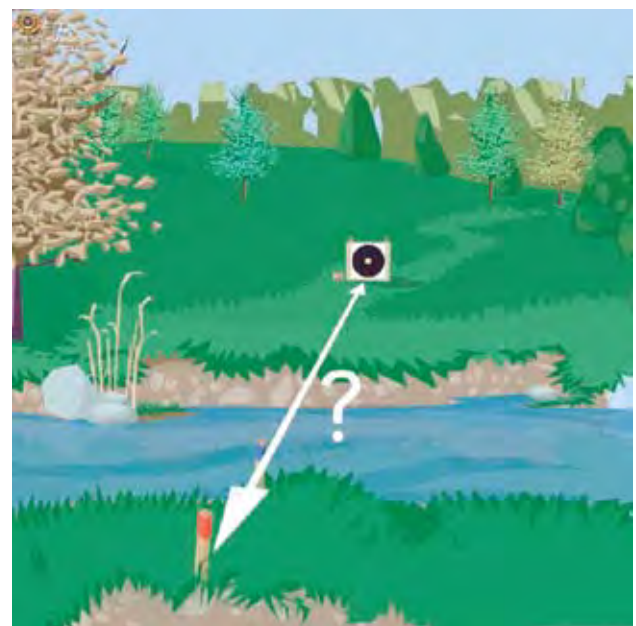

The targets are arranged along the course with difficulties in aiming and shooting as the spirit and traditions of the discipline requires and in harmony with the terrain.

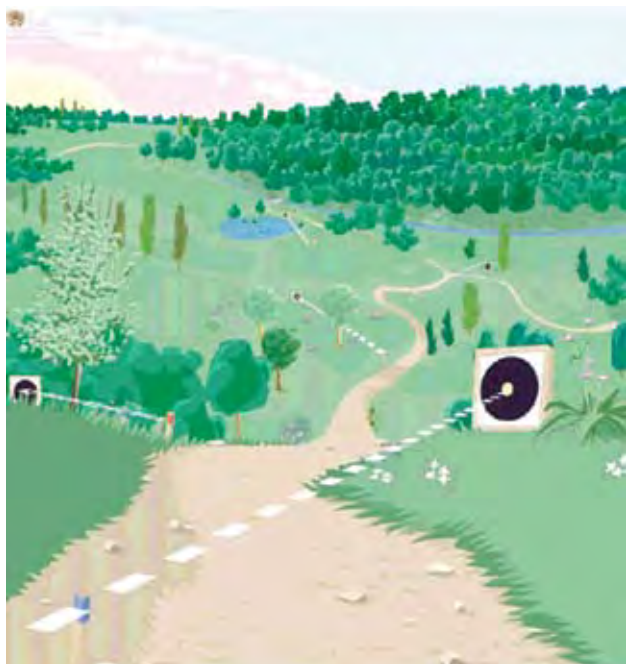

The top sixteen competitors in each division and class from the Qualification Round shoot the first Elimination Round.

An Elimination Round is a twelve targets course with a time limit of four minutes for an end of three arrows. Six targets are marked and six are unmarked. The top eight in each division and class from the first Elimination Round shoot a second Elimination Round.

*Unit for Elimination Round,*

*(Marked and Unmarked) 2 X 6 targets, each unit of 6 targets will contain 3 Marked and 3 Unmarked distances:*

Number of Targets	Diameter of Field Faces in cm	Number of Faces	Distances in Meters	
			Blue Peg Barebow	Red Peg Recurve and Compound
1	Ø 20	12	5-10	10-15
1	Ø 40	4	10-20	15-25
1	Ø 60	1	15-30	20-35
1	Ø 80	1	30-45	35-55
1	Ø 40	4	10-20	15-25
1	Ø 60	1	15-30	20-35
1	Ø 60	1	30	35
1	Ø 80	1	45	55
1	Ø 20	12	10	15
1	Ø 40	4	20	25
1	Ø 60	1	40	45
1	Ø 80	1	50	60

In the Final Rounds, the top four competitors in each class and division shoot two matches each on 4 marked targets. The number one archer competes against the

number four and the number two against the number three (Semi-Finals).

The four-minute limit is strictly applied in the (Semi) Finals.

*Unit for Finals Rounds (and Team Quarter Finals) 8 (2 x 4) targets with marked distances:*

Number of Targets	Diameter of Field Faces in cm	Number of Faces	Distances in Meters	
			Blue Peg Barebow	Red Peg Recurve and Compound
1	Ø 20	12	15	20
1	Ø 40	4	25	30
1	Ø 60	2	35	40
1	Ø 80	2	45	55
1	Ø 20	12	10	15
1	Ø 40	4	20	25
1	Ø 60	2	40	45
1	Ø 80	2	50	60

Thereafter, the losers compete for the Bronze Medal and the winners for Gold and Silver (Finals). For the Finals four additional marked targets are used.



**Team event**

After the Individual event there is also a team ranking. The top eight teams in each class shoot a team elimination round. (Four Matches in total). A team consists of three competitors, one from each division. Throughout the team event, each competitor shoots one arrow per target. The Quarter Finals team elimination round is an 8 marked targets course. The winner of each match will proceed to the Team Finals Round (Semi-Finals) on a 4 marked targets course. The losing teams from the Semi



Finals advance to the Bronze Medal Match and the winning teams advance to the Gold Medal Match. Both Final matches are shot on four additional marked targets.

### Scoring

The target faces in field archery have a gold spot and four black scoring rings; the diagram below shows the scoring zones.

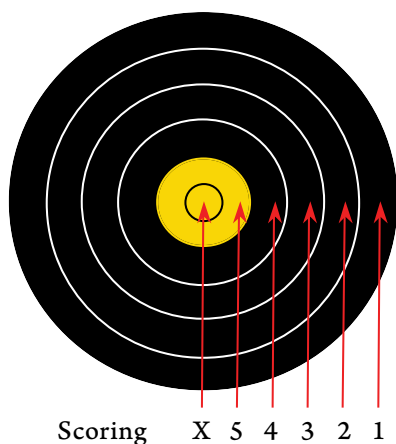

### Forest round

The distances of the targets of the same size shall vary between long, middle and short. The forest round has the same characteristic as in Field Archery except for the following aspects:

- It includes the longbow and traditional bow division, which shoot from the blue peg.
- It consists of a number of targets between 12 and 24 which is divisible by 4.
- All archers shoot up to 3 arrows per target.
- The Forest round is normally shot on unmarked courses but may be shot on marked courses provided the distances are kept within the limits as set in the rules.
- For each archer, all arrows must be numerically marked and shot in ascending order.

### A Unit for Forest Round

Number of Targets	Diameter of inner rings	Distance in Meters	
		Blue peg Barebow, Longbow, Bow Hunter	Red Peg Recurve and Compound
3	Ø 7.5/5cm	5 – 10	5 – 15
3	Ø 15/10cm	5 – 20	5 – 25
3	Ø 22.5/15cm	5 – 30	5 – 35
3	Ø 30/20cm	5 – 45	5 – 55

### Scoring

In the FITA Forest Round only the first arrow hitting the scoring area will be scored in accordance with the following:

Arrow hit	1st Arrow	2nd Arrow	3rd Arrow
Inner Ring	15 points	10 points	5 points
Outer Ring	12 points	7 points	2 points

The Forest Round may be scored as in 3D, using the single arrow principle, at the organizer's discretion, in which case the smallest ring (X-ring) becomes the 15 point ring, the inner ring becomes the 12 point ring and the outer contour of the animal target face becomes the 7 point ring.

In the FITA Forest Round, picture faces may be used as set forth below:

Diameter of Inner Rings			
Ø 7.5/5cm	Ø 15/10cm	Ø 22.5/15cm	Ø 30/20cm
Typical Animals, such as:			
Squirrel Rabbit Marten Woodcock	Hare Fox Raccoon Wood Grouse	Roe Deer Wolverine Wolf	Bear Deer Wild Boar

The Forest Round target faces consist of pictures (photograph / drawing / painting) of animals (see chart) with such colours and contrast that people with normal eyesight can see them clearly under normal daylight conditions at the relevant distances.





Vital Wound

The pictures should be printed on a white background. The picture faces have two concentric inner rings and an outer ring/line. The smaller inner ring is marked X, the larger inner ring is the higher scoring zone. The outer ring corresponds to the animal's body contour if this is clear, otherwise there shall be a clear line closely following the body contour.

Organizers may use 3-D animal figures in addition to, or instead of, animal faces.

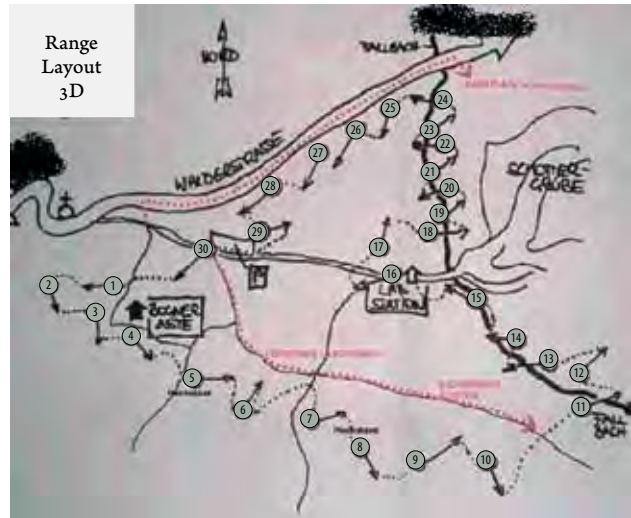

- |                  |                    |                 |
|------------------|--------------------|-----------------|
| 1. Mountain Goat | 12. Mule Deer      | 22. Puma        |
| 2. Fox           | 13. Turkey         | 23. Bison       |
| 3. Deer-standing | 14. Bobcat         | 24. Hyena       |
| 4. Boar          | 15. Rabbit         | 25. Caribou     |
| 5. Javeline      | Rest station       | 26. Antelope    |
| 6. Wolf          | 16. Coyote         | 27. Fox         |
| 7. Lynx          | 17. Warthog        | 28. Turkey-side |
| 8. Bear-standing | 18. Deer-laying    | 29. Reindeer    |
| 9. Jackals       | 19. Beaver         | 30. Bear        |
| 10. Raccoon      | 20. Woodchuck      |                 |
| 11. Lion         | 21. Big Horn Sheep |                 |

The 3D Animal round or 3D round for short, has the same characteristics as in Field Archery except for the following:

- The 3D Round may be shot by the Recurve, the Compound, the Bare-bow, the Longbow and the Bow Hunter divisions.
- The round is shot on any number of 3D or silhouette animal targets of varying sizes, each having a marked centre ring and a marked critical ring ('heart/lung ring').
- One arrow per archer per target.
- The maximum time permitted to shoot the arrow is 2 minutes.
- The 3D round may also be scored using the 3-arrow principle as in the Forest round, at the organizer's discretion.



The distances are not marked and vary within the following limitations:

- Between 5-45m for the FITA Compound and Recurve divisions.



- Between 5-30m for the FITA Bare bow, the Longbow and the Bow Hunter divisions.

### Scoring

Scoring Zones in a 3D Animal round:

- 15 points for the centre ring zone.
- 12 points for the critical ring zone.
- 7 points for the rest of the animal figure, except antlers, hooves, cloves.



For an arrow to score, the arrow shall hit and remain (be stuck) in the 3D figure.



In the case that animal targets are used with more than two rings engraved, the second smallest will become the centre ring and the biggest will become the critical ring zone. If the animal target has more than two rings, the smallest ring may be used as an X-ring at the organizer's discretion. The 3D round may also be scored using the 3-arrow principle as in the Forest round, at the organizer's discretion. The centre ring becomes the X ring and the critical ring becomes the Inner Ring (of the Forest round), the rest of the animal (silhouette) becomes the outer ring. If there are more than two rings on any animal

target, the second smallest becomes the X ring and the largest remains the critical ring zone, corresponding to the Inner Ring of the Forest Round and scoring 15/10/5 points. The rest of the animal (silhouette) becomes the Outer Ring scoring 12/7/2 points.

### 3DI round

A very new round in the FITA is the 3DI with its own World Championship 3DI Rules represent a joint venture of 3DI and FITA. The rules are based upon 3DI rules with the goal to make 3D more popular within FITA and to achieve a closer cooperation with 3DI. The 3DI round has a lot of the same characteristics as in Field archery except for the following aspects.

- One archer at a time.
- One arrow (only) per archer per target.
- When shooting, the archer must touch the peg with a portion of their body.
- Pegs farthest from the target must be shot first, unless directed otherwise by a shoot official.
- There is to be no discussion of yardage / distance until the target has been scored.



### Shooting pegs

- Red: Men and Women Compound Bow maximum distance: 45 meters (50 yards).
- Blue: Men and Women Barebow  
Men and Women Longbow  
Men and Women Instinctive Bow  
maximum distance: 30 meters (33 yards).
- The first archer in the group has two minutes; each following archer in the group has two minutes after the release of his predecessor.
- Cameras or distance estimating devices are not allowed on any of the shooting distances regardless of use. Binoculars (hand held) will be allowed with a maximum magnification of 8,5X according to the manufacturer's specification.

### Scoring

For all sanctioned 3DI-shooting events, the scoring shall be as follows:

- X Small circle centred within the ten ring. Approximately 25% of the ten ring will be used. The arrow must at least touch the circle line. This score would reflect X-10 on the scorecard.
- 10 Circle inside vital area. The arrow must at least touch circle line.
- 8 Vital area other than the 10 point area. The arrow must at least touch the vital area line.
- 5 Remainder of the animal touching body colour.
- 0 A hit in the horn or hoof not touching body colour, any other miss, or glance off.

All scoring zones can be used unless otherwise noted at shooting peg.

Removing of arrows should be done with care for the arrows as well as for the deer targets. Recommended is the one hand method where one hand is on the deer pushing and the other one on the arrow shaft close to the impact point, pulling.



Another technique is with two hands on the arrow shaft close to the arrow impact and the body leaning against the deer.



## Chapter 2.

### Equipment

#### Sight

Traditionally a bow has no special aiming device. The bow hunter caught his prey by shooting instinctively, without even having the time for conscious aiming; bare bow archers use a fixed point on the bow or arrow to give the bow the necessary elevation by bringing this point on the virtual line between the eye and the target, which is the essence of aiming.

Modern bows have a special aiming device, the sight. A sight is a sliding device adjusted on the bow with which a fixed aiming point called sight pin can be fixed in place in order to give the bow the desired elevation during aiming.

A sight has a ruler with a scale usually indicating centimetres, millimetres and tenths of millimetres. The scale can indicate for instance from 0.00 cm to 9.00 cm. Depending on how the archer mounted the sight, the point of zero elevation (shooting straight forward) is somewhere at the top of the ruler.

In target archery we need only four marks on the scale of the sight, one for each distance. In field archery we have to shoot any distance between five and sixty meters and it is not possible consequently to have each distance marked on the sight. It is recommended to put some marks on the sight bar and to keep a table of sight marks between 5 and 60 meters on a piece of paper in the pocket. A field archer needs to know his sight marks at every 2.5 meter on the shorter distances and at every 5 meter on the longer distances. Confidence in performance for field archers strongly depends on their confidence in their table of sight marks.



### **Tuning**

One can often see that a target archer adjusts the side setting of his sight when changing distances, in addition to the vertical sight setting he is adjusting his sight pin horizontally in or out. The reason for this is probably because his sight bar is set parallel to his sight window (bow riser) but he is holding the bow slightly tilted, which is quite normal and often preferred. It is preferred because your normal body line often makes it natural to hold the bow tilted and if resisting this natural stance you will have to force your body, or arm/shoulder into a position which is not natural and which may implement muscle strain and/or shooting errors. On a target round this need for side adjustment is not a big problem, but for a field archer this adjusting would be hopeless to keep track of, and thus we must correct our equipment accordingly.

Have someone help you to check by eyesight or by means of a level instrument that your sight ruler is vertical when you shoot – it doesn't matter how much you tilt your bow. As long as the ruler of your sight is vertical there will be no need for horizontal adjustment on different distances. (Depending of course, as long as you do not change the degree you tilt your bow). Tilting the bow, even the compound bow, may be an advantage to most archers. However, there may be one problem if you tilt the bow too much to the left (right handed archer) you may discover that by keeping the sight bar vertical the sight pin/ring may be hidden behind the riser on the longer distances. If this becomes a problem you will have to alter the bow grip or your shooting technique in order to limit the bow tilt.

Field archers must hit a small spot on distances from 5 meter and onwards, and therefore the bow/arrow combination should be well tuned so that the arrows leave the string as straight as possible.

Draw a horizontal line on your target or stick a narrow, good visible line of tape and shoot an arrow at that line from every meter between 5 and 10 and from every 2.5 meter between 10 and 20. Use the correct sight marks. Measure only the deviation from the (horizontal) line. If your arrows hit close to the horizontal line on those distances, they fly close to the horizontal plane. (See Manual 1 for 'horizontal' plane).

Next, tape a vertical line and shoot from every 1 meter between 5 and 10 and from every 2.5 meter between 10 and 20. Measure the deviation from the vertical line only.

If your arrows hit close to the vertical line on those distances, they fly close to the vertical shooting plane.

If your arrows fly close to the horizontal and the shooting planes, they will also fly straight on longer distances. If you are unable to hit the horizontal and/or vertical tape on the shorter distances it may mean your arrows are 'wobbling' too much and that you must continue tuning (optimising) your equipment.

## **Chapter 3.**

### **Range Finding**

Dead ground, such as where archers are looking over a ridge at a target and can't see the ground area between them and the target, or shooting over water, are notoriously difficult situations to estimate distance. The same is true, to lesser extent, when shooting across a valley where the direct distance is very different to the ground distance.



In the FITA Field (on the unmarked targets), the Forest and the 3-D rounds, archers have to guess the distance to a target on a place they may never have been before. This is a special challenge for most field archers. Hence one important shooting skill consists of making accurate distance estimations. Good intuition and terrain evaluation is not enough, as these are too inaccurate.

Unmarked distances are not completely unknown. According to the rules, unmarked targets can only be mounted between certain distances.

Number of 12 targets in a unit max – min #	Diameter of Field Faces in cm	Distances in Meters (unmarked)		
		Yellow Peg Cadet Bare Bow	Blue Peg Barebow, Cadet Recurve, Cadet Compound	Red Peg Recurve and Compound
2-4	Ø 20	5-10	5-10	10-15
2-4	Ø 40	10-15	10-20	15-25
2-4	Ø 60	15-25	15-30	20-35
2-4	Ø 80	20-35	30-45	35-55

Number of Targets	Diameter of Field Faces in cm	Distances in Meters (marked)		
		Yellow Peg Cadet Barebow	Blue Peg Barebow, Cadet Recurve, Cadet Compound	Red Peg Recurve and Compound
3	Ø 20	5-10-15	5-10-15	10-15-20
3	Ø 40	10-15-20	15-20-25	20-25-30
3	Ø 60	20-25-30	30-35-40	35-40-45
3	Ø 80	30-35-40	40-45-50	50-55-60

The distance of an 80 cm target face for instance from the shooting position of Recurve and compound archers is between 35 and 55 meters, and just by using the knowledge of the rules an archer can estimate the distance at 45 meters, which is obviously within 10 meter of the real distance. Although this is ranging the distance very basic, the archers have already a guess that gets the arrow on the butt. The 80cm target face is really the most complicated target on the unmarked round and it is clear that archers are happy to hit at least the butt.

Generally speaking it is the longer distances the archer needs to concentrate on for guessing. Archers may well have trouble in getting high scores at shorter distances and smaller targets, but most probably this has to do with the

archer's bow tuning and technique, more than distance measuring. At the shorter distances, the extent of compensation is by far less, especially when using a fast bow. Also, the smaller targets are easier to be recognized, especially in FITA rounds, so they will not confuse the archers.

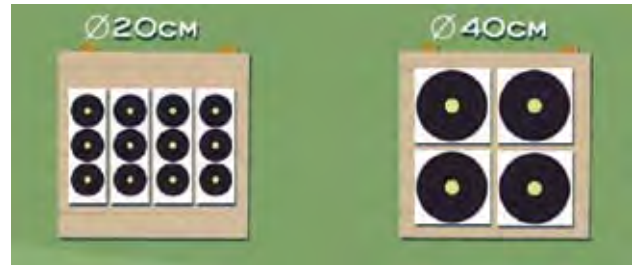

In the unmarked round it's the 60 cm and 80 cm target faces, which can cause the archer some concern in deciding which size face they are about to shoot at.

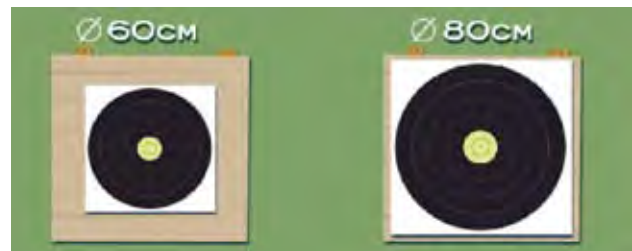

Shooting a lot of field competitions on unmarked distances will give the archers more and more experience, which also allows them to achieve higher scores.

The FITA rules clearly state that the use of range finding devices is not allowed. It is not possible however to prevent archers from measuring the distance to the target by applying their common equipment.



Rules and judges are there to keep special range finder devices out of competition. The measuring methods mentioned below do not use exceptional devices for range finding.

Archers are allowed to use any information from the Rules. So, they can have a list of all the distances each target must be set in for each bow style. The archer can come to full draw and then compare the size of a special part of the bow with the known size of the target face.

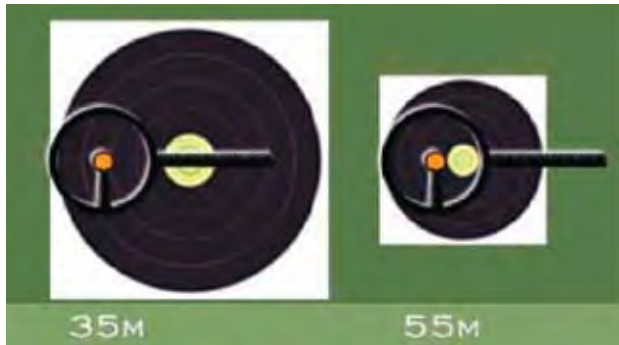

It is indeed possible to estimate the distance to the target very accurately using previous tests during practicing. This type of estimating is actually not according to the spirit of the rules, but it is difficult to prove it is being used.

Archers are not allowed to discuss distances on the course, to prevent them from giving advice or misleading information to other competitors. The use of mobile phones or radio technique is prohibited for the same reason. Archers are not allowed to pace out the distance between pegs as they go to their own shooting peg to take up their position. (For example the bare bow archer go to their peg while passing the red peg).

Field archers need to find their own method of estimating distances (range finding) and this needs to be practiced as part of their shooting form. Whatever method of estimating the archer chooses to apply, there are also special factors to take into account.

The course setter is pitting their wits against archers, and will try everything to confuse the archer. Course setters don't like to make the target size obvious. They use tricks such as putting a small target face on a small butt, making it look like a large target face on a normal size butt. It is important to know the course setter as each of them has their own 'signature'.

The more field practice the archers do the more they get a feeling for distance, and how to reliably estimate distances. With increasing experience they will be able to

take advantage out of every single hint or sign in the surroundings to improve their skills in estimating distances as exact as possible.

### Practice exercises for range finding:

- A. During practice in the field the following task is instructive for the archer.
  1. Note the first thought about the distance that came up arriving at the peg.
  2. Note the distance which was decided to shoot the arrow.
  3. Measure and note the true distance.
 Experience shows that in about 95% of all cases the first thought is correct, but is followed by a different decision due to doubt.
- B. Judging by feel means that archers learn to judge the distance by 'feeling' the size of the target in relation to the distance. In order to do this they need to practice a lot, but below you will see a few suggestions: Take different Target Deer / Target faces glued onto cardboard and place them in the field and let archers judge the distance and then measure them yourself.
- C. Notice the different sizes of field faces, animal faces or 3D deer on various distances (start with the maximum distances), shoot at the targets while getting accustomed with their sizes.
- D. Locate the targets or 3D deer in the field, judge the distance by 'feeling', shoot at them, measure the distance using a measuring-line or by counting steps. Always remember the maximum distance for that particular target face, animal face or 3D deer according to the rules. (Archers may be fooled, try to judge by the spot size rather than the size of the whole target face). It is common to judge the distance too short!
- E. A useful distance training exercise is that you and your archers take a suitable measure-line or distance finder and go for a walk in the countryside, woods or mountains. Challenge the archers to guess the distance to nominated trees, plants or objects. Then check their accuracy by measuring.
- F. Learn how distances of 10 meters look like in various terrain.



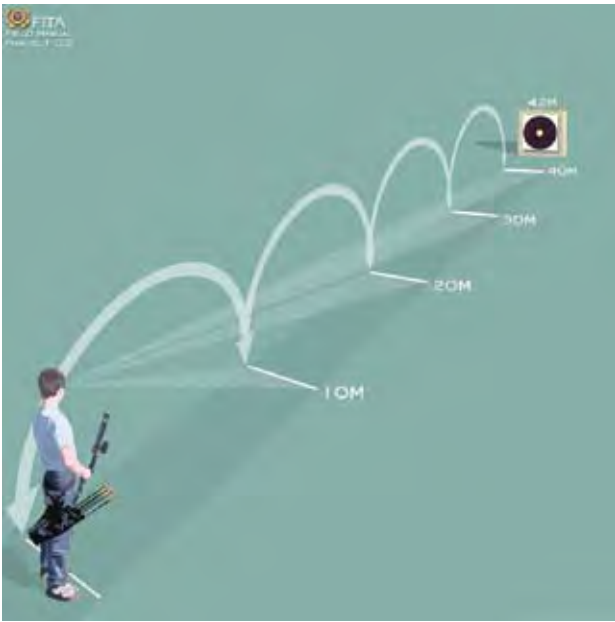

Find a point at 10 metres away from the archer; copy this 10 metre distance visually until close to the target. Add or subtract the remaining distance. An error of X% in the 10 metres guess implies an error of X% error in the estimated distance.

**G.** Try to find a point half-way to a given object and estimate the distance to that point.

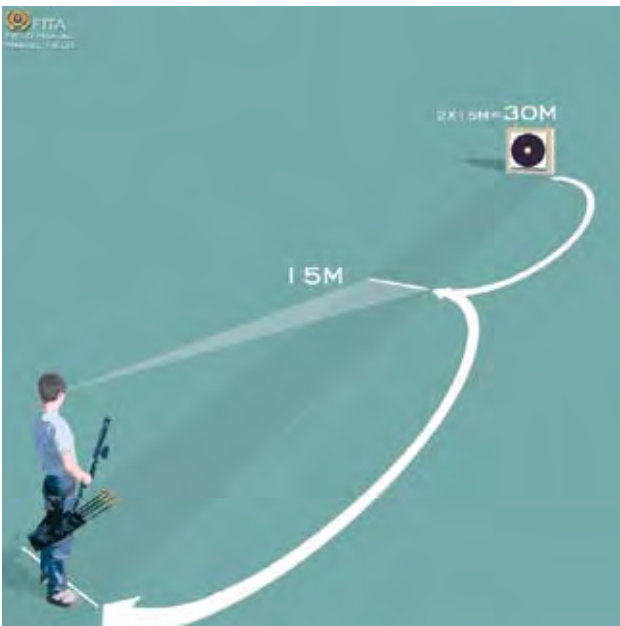

Then double this distance and find the estimated distance to the given object. X% error in the half-way guess implies  $X \times 2\%$  error in the estimated distance.

**H.** The 'owl' method is used when the archer is unable to oversee the terrain in front of the butt. Judge the distance to an object somewhere in between archer and

the target. Notice how this object is situated in relation to the target.

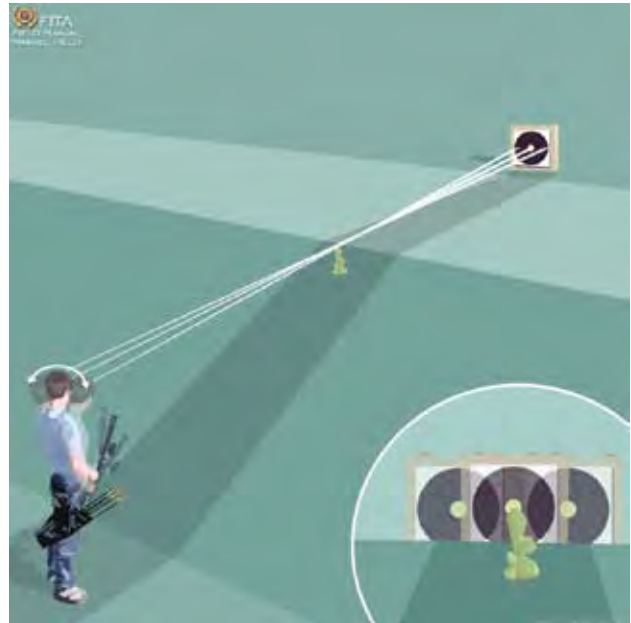

Then you move your head sideways and notice how that object moves relatively to the target. If it moves just a little bit, the distance between object and target is small, if it moves equal to your head movement it is half way in between, and if it moves more than your head, the object is nearer than halfway to the target.

- I.** If an archer has to shoot prior to you, then you listen how much time it takes between the release and arrow impact on the target and estimate the distance. This technique needs a lot of experience but can be very accurate.
- J.** Archers can get some information looking through their binoculars at arrow holes punched in the target face or 3D deer. With some experience you will know what the size of an arrow hole should look like relative to the gold / killing zone and get a clue or confirmation of target face / 3D deer size.

If, for example, most of the holes are below the gold / killing zone, it indicates that many of the preceding archers underestimated the distance. An archer might therefore deduce that the target is further away than it looks like. If the archer is not the first one in their group to shoot they might get confirmation of this observation by watching where the arrow of the target partner hits, weighing this against their (assumed) ability. If an archer watches archers from the preceding group still standing beside a target

face, or a 3D deer, it can help them in judging what size (or at what distance) it is.



It is therefore in the archer's interest, to leave the target immediately after scoring to avoid giving information away.

- K. Most of this information is reassurance, rather than a dead give away and, rather than to seek it, occurs during the shoot.
- L. The archer estimates the distance between the target and a tree let's say-15 meters in the example below.

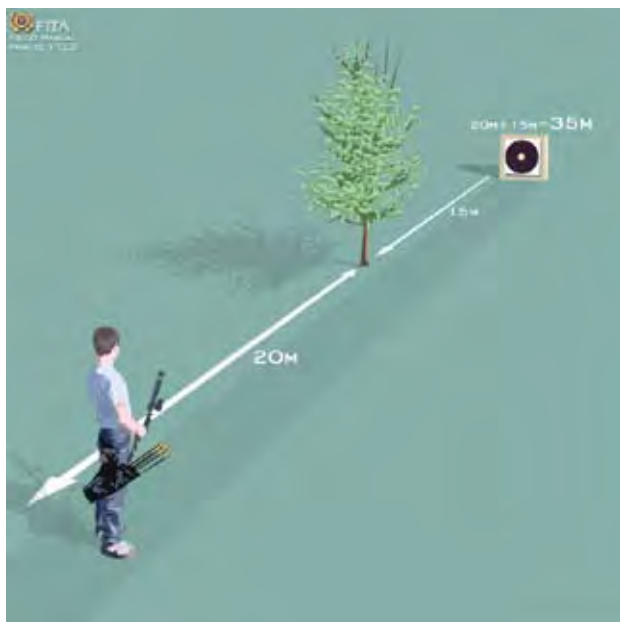

Then they estimate the distance between the tree and them self-20 meters in this example. Hence the total distance is 35 meters.

- M. There are often other clues to work out the distance. By looking at surrounding objects archers can quickly get a feeling for distance. For example, if a target, or 3D deer, is placed down a row of trees, archers can eas-

ily estimate the distance between each tree, normally, in a plantation of trees, the gap is usually exactly five meters between each tree, (depending in which part of the world or even country) count the gaps and the archer will know the distance.



- N. In the FITA Field rounds – for any given target size, the red peg upper and lower limits are 5 metres more than the blue peg. That is except for the maximum distance being shot on the 80 cm face. Here the difference is 10 metres.



For example, for a 40cm target face, the blue peg is between 10 and 20 meters while the red one is between 15 and 25 meters away from the target. It is therefore important to remember, or to have a note of the distance for both pegs of either colour. By estimating the distance be-

tween the two pegs, and also from each peg to the target, archers get a means of cross checking distances. Sometimes the two pegs are set side-by-side, so in the above example for a 40 cm target, archers would know that the distance must be between 15 meters (the red minimum) and 20 meters (the blue maximum). Very occasionally, the blue is set further then the red so guessing that is a little tricky.

- O. If the archer is uncertain about the distance and assumes it may be a little further than it looks; they should go for the ‘percentage shot’. Set the longer distance and aim the first arrow a little low, say at 6 o’clock in the 4-ring. With this trick the arrow will then hit into the low 4, the 5 or high 4, depending on the degree of misjudgement. If the archer aims at the 5, they risk a 12 o’clock 4 or 3 and maybe, even worse. Alternatively, the archer could set up the short distance and aim high.
- P. If the archer is really uncertain of the distance to the target, they should definitely go for the ‘mathematic shot’.

Example: The 60cm target face in the unmarked course for recurve/compound is 20 – 35 metres. Take half of the difference and add 1 meter:  $27 \frac{1}{2} + 1 = 28 \frac{1}{2}$  meter. This gives an indication for the archer’s first arrow. Practice makes perfect and, by continually testing the archer’s own estimating ability, they will improve. This will increase their confidence and performance.

**Range finding with sight**

If we know the distance from the dominant eye to an aiming object on the bow (e.g. sight ring, scope, arrow rest), called ‘d’, and the width of that object ‘a’, and we know the width of the target ‘A’, and we call the distance to the target to be discovered as ‘D’, then the relationship  $a / d = A / D$  will give you the distance to the target by simple calculation. This method is based on knowing the size of the target face or buttress. Recognizing the target faces of 20 or 40 cm presents no problem, as the target layout tells you the target size (‘bunny’ or quadruple). But if you mistake an 80cm target face for a 60cm target face, or vice versa, it will result in an error in the distance estimation between 10 and 15 meters. This would result in an error that would be a big loss in the score. It is in this case that the field evaluation, and your own experience or intuition should

help; besides of course, studying the various makes of target faces in order to see and consider the difference.

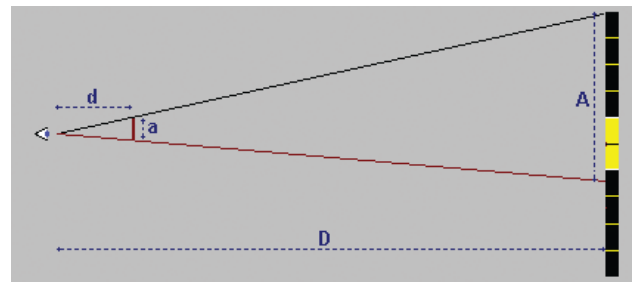

*View from side: D is distance to target*

1. Align the pin up a 20cm target face and a 40cm target face on the butt.
2. Measure and mark 20m and 40m from the butt.
3. Go to the 20m mark with your bow.
4. By aiming at full draw find something in front of you that covers the 20cm face, for instance the inside or outside of the sight ring, the threaded part between the ring and the sight, the bubble on the level, the spot or ring on the glass, the with of the arrow, parts on the arrow rest and so on an so forth.

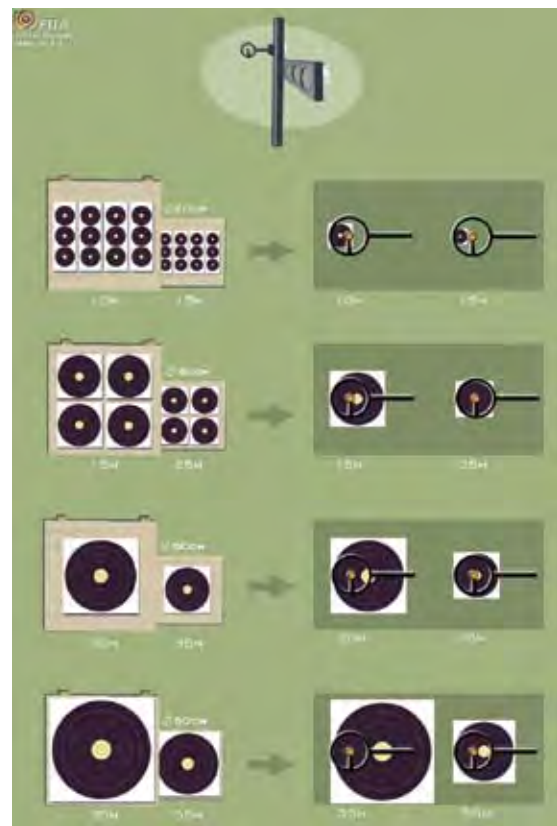

5. If you are unable to find something, you have to modify i.e. change the sight ring or something else which will give the exact measurement of 20cm from 20m

distance. (Remember to use only manufacturers' parts and not your own modifications).

6. Once you have found the correct ring (or whatever) size, go to the 40m mark and measure the 40cm target face. If this is correct, and it should be if you have been accurate enough on the 20cm, you are now able to measure any distance provided you know the size of the object you are measuring on – you need to know if it is a 20cm, 40cm, 60cm or 80 target face you are measuring, but you can also use the size of the butt or any other object you are familiar with.

In practice you proceed as follows. When aiming at full draw you check and see /evaluate how many centimetres you measure on the target face – remember you must always use the same technique, because the distance between your aiming eye and the part on the bow with which you use to measure must be the same. The number of centimetres that you measure on the target face equals the number of meters, which is the distance from where you stand to the target face you are measuring on.

If you stand on an unmarked peg and can measure 40cm on an 80cm target face – the distance is 40m. On a 60cm target face the same situation would give you 30m, and on a 40cm target face it would be 20m. 40 cm on an 80cm target face is exact through the middle – the relationship is also valid for the other target face sizes.

If you measure on an 80cm target face from the edge of the black to the edge of the gold on the opposite side the distance is 48m, as  $40+8 = 48\text{cm}$ ; with a 60cm target face you get  $30+6 = 36\text{cm}$  which gives you 36m. If on the other hand, you measure from the edge of the black and your measuring device reaches to the 4 ring on the opposite side of the centre, the distance is  $40+8+8 = 56\text{cm}$  which gives you 56m (in case of an 80cm target face) whereas on a 60cm target face you would get 42m, as  $30+6+6 = 42\text{cm}$ .

Remember! This is information you have to learn and keep in your mind, as you are not allowed to carry memoranda on the course. You may, however, have copies of parts of the Rules Book with you.

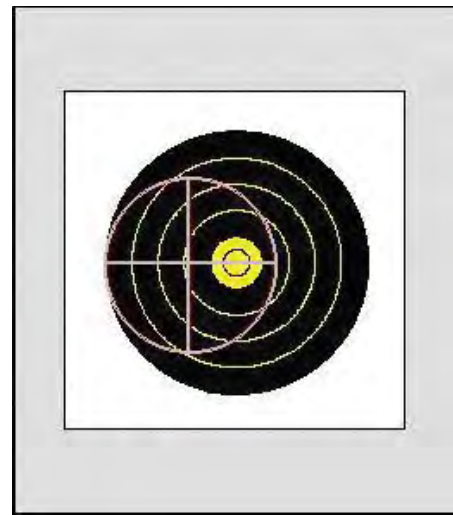

The above example shows a sight ring that covers the face from the edge of the black to 'a little' more than the centre of the four ring: On an 80cm target face this would correspond to approximately 40cm (half of the face) + 8cm (half of the gold) + 5cm (plus a 'little more' than half of the width of the four ring which is 8cm) = 53cm and consequently 53m

On a 60cm target face it would correspond to  $30\text{cm} + 6\text{cm} + 4\text{cm} = 40\text{cm}$  and thus 40m, which is outside the allowed distance for a 60 cm face, which means, this must be an 80 cm face you will be shooting at.

On a 40cm target face it would correspond to  $20\text{cm} + 4\text{cm} + 3\text{cm} = 27\text{cm}$  and thus 27m. If you miss by one cm or two, you miscalculate the sight setting by one meter or two, which is still acceptable.

For further information and divining field strategies you have a look into: FITA Field Organizers Manual. This gives the archer an idea on what they can expect from the course builders, as mentioned before each course builder has their own signature concerning course building. Archers can of course use the same rules and formulas on animal targets or 3D rounds as long as they know the target sizes. For the experienced field or 3D archer there is no such thing as unmarked distances. That is just for those who don't take the time necessary to learn how to do it.

### ***Range Finding for Forest and 3D Animal rounds***

Many rules and formulas of range finding in Field archery are also valid for Forest and 3D rounds, if we read 'animal' instead of 'target face'. Archers are allowed to be aware of any information that appears in the Rule Book, so archers can use the list out of this book containing the minimum and maximum distances for each animal target and for



each bow discipline. Archers must be able to recognize all animal target faces and even those made by the organization (which will be announced and shown before the tournament starts).



Once archers have mastered the ability to hit the vital/scoring zone consistently from known distances, it is about time to move on to the next step. Remove all the distance markers and shoot by simply judging the distance to the target. The ability to determine distances is usually the greatest challenge an archer will face. A wrong guess can send the arrow either high or low of the vital/scoring zone. Archers can spend a lifetime perfecting this ability.

## Chapter 4.

### *Uphill and downhill shooting*

A sight mark corresponds to a certain elevation of the bow while aiming. In target archery it also corresponds to a certain distance to shoot. In field archery, when shooting uphill or downhill, elevation depends not only on the distance to shoot, but also on the difference in altitude to overcome. 'Distance to aim at' can be different from 'distance to shoot'. The field archer corrects (by adding or subtracting a few metres) according to the slope.

#### ***Distance to shoot + Correction = Distance to aim at***

The archer has to learn by experience how much to correct in different situations. How much distance to subtract, has to be discovered by each individual archer, it depends on the archer's equipment and shooting technique. Distance correction for slopes is an art in itself, but generally the distance to aim is less than the distance to shoot for both uphill and downhill shooting. Below are some popular corrections for inexperienced field archers:

### ***Sighting for shooting uphill***

- At a slight slope, and especially at long distances, add one or two meters to the real distance (dependent of the meter / yardage and the efficiency of the bow).



- At a very steep slope, deduct at least two meters from the real distance (dependent of the meter / yardage and the efficiency of the bow).



The steeper the slope, the more the archer subtracts; however, in uphill shooting above a certain distance, called the 'jump', the rule is 'the steeper the slope, the less to subtract'. The distance of this 'jump' is dependant on the efficiency of the bow.

### ***Sighting for shooting downhill***

At a slight slope, deduct one, two or three meters from the real distance (dependent of the meter / yardage and the efficiency of the bow).



At a very steep slope, deduct up to 10 meters from the distance (dependent of the meter / yardage and the efficiency of the bow).

We can calculate the “jump” as follows. Write down the sight marks from 10 meter up to 50 meter distance with a step of 5 meter in a table. Next we add one column to the table in which we calculate between 15 and 60 meter the difference between two adjacent sight marks. The differences (adjustments for 5 meters further) are pretty constant below about 35 meters. Between 35 and 45 meters the list of differences makes a ‘jump’, maybe to about the double of the previous differences, and then become approximately constant again.

When the distance uphill or downhill is not marked and has to be estimated, usually an uphill target is judged too short and a downhill target is usually judged too far. For this reason the archer should as a rule add a few metres to his estimation when shooting uphill and subtract a few metres when shooting downhill.

Shooting more or less straight up or straight down, archers have to see it to believe it, let them try their 15 metres mark.

### ***Posture for shooting uphill with level feet position***

The basic posture is always the ‘T’ as in target archery.



For slight uphill shots move the hips towards the target before the draw, for steep uphill shots put the bow foot forward and move the hips towards the target before the draw.



At even steeper uphill shots you could move the string foot a little backwards so that you get more room in the chest to hold the correct draw length. Too little ‘swing’ in the hips, gives a wrong shoulder and bow arm position, shorter draw length and probably a bad release.



### ***Posture for shooting downhill with level feet position***

At slight downhill shots move their hips away from the target before the draw.



The downhill standard position is a swing in the hips to the rear and a wide stance.



Or even face the target with whole body and twist upper body towards the target face. Although anatomical not reasonable it is only for three shots and archer has a good balance.



For steep downhill shots let the archer take an open stance and move their hips away from the target; have the archer straighten their upper body before the draw. The steeper downhill the shot the more the archer has to open their stance.

***Posture for shooting uphill on sloping ground:***

With very steep uphill shots, sometimes archers shooting position will become more stable if they kneel on their forward knee.

***Examples of common mistakes***

- Hips not forward enough, giving wrong shoulder and bow arm position, shorter draw length and probably a bad release.
- Tilting the bow causing left or right hits.
- Bent knees give unstable shooting.



***Posture for shooting downhill on sloping ground***

For a downhill shot we put the feet wide apart and push the hips away from the target.





With a very steep downhill shot and an extremely steep hillside sometimes the archers shooting position will become more stable if they kneel on their rear knee.



In extreme slippery conditions archer can push their bow stand into the ground to give support to the front or back foot and to avoid slipping down the hill.

## Chapter 5.

### *Training for field archery*

Field archers must carry their complete outfit for a whole day of competition, they must have had sufficient rest and they should be fully motivated. They should practice in all weather conditions, to learn to react to wind and rain conditions and to be aware of the different sight adjust-

ments required. Athletes who want to be good field archers practice on both target and field archery distances.

### *The coach should include the following into the training program*

- Alter of the shooting rhythm in the one arrow sequence as well as in the three-arrow sequence. In gusty wind conditions shoot when the conditions suit you.
- Shoot with reserve equipment (reserve bow, bowstring, finger tab or release aid, reserve arrows).
- Arrange for each archer to shoot in a lot of competitions with different opponents.
- Tactical time training (conscious training of the time rhythm during rests between targets).
- Individual and team event training with opponents.
- Imitation of different field competition situations i.e. shoot-offs and visualization of a Field competition situation.
- Practice to identify different target faces from varying distances.
- Practice in natural surroundings (use different terrain like woods, mountains, slopes etc.).
- Make optimal use of the field glasses/ binoculars (for target identification, arrow holes information, arrow sighting, etc.).

### *Organizational preparations for outdoor practice*

- Plan your training sessions well in advance so that you can inform the authorities, i.e. land owner, game warden and so on.
- Make your emergency plan for each course, plan and organize training sessions with safety in mind.
- Make a plan of the safe paths for each target lay-out, keeping in mind all aspects of arrow flight.
- Plan in advance what materials are needed for that particular training session. For instance arrow stop nets, tape, signs, first aid kit.
- Plan to have someone at hand who is familiar with using the first aid kit.

### *Facility*

- Secure the field you want to use with signs and tape to keep out wanderers, mountain bikers or even horseback riders.
- Inspect the field of hazardous objects before every training session (especially after stormy weather conditions).



- Inspect the targets before each training session.
- Beware of the safety zones especially with uphill targets. At uphill targets, be aware that there is a natural barrier or net to stop arrows that miss the target.
- Before each training session convince yourself that all is free of obstacles, and live stock.
- Attach marking tape for a safe walking path to the targets (clockwise from target to target).
- Have reserve target faces laid down behind the targets.

**Tips for preparing the practice site**

- For the first practice session, it is recommended that the shooting distances are not at the maximum distance. Let the archer get acquainted with the natural surroundings first before going on to the maximum distances. (Especially for the uphill targets). It gives you the opportunity to observe your archers and their behaviour in the field. It is recommended that this first shoot is on even ground in the woods or on a plain so that the archers get the feeling of shooting in the field.
- When setting out a field practice course it will not be necessary to set up a lot of targets. The recommendation is, when the field allows it, to set the targets in a circle so that the coach, by standing in the middle, has a good view on the targets around.

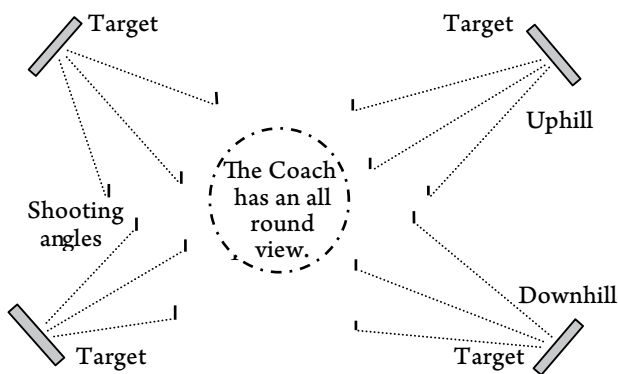

- Give each target different shooting positions and angles.



- Set out targets, if possible, so that all aspects of field archery can be practiced, like from light to dark surrounding or from dark to light or even making use of a lake.

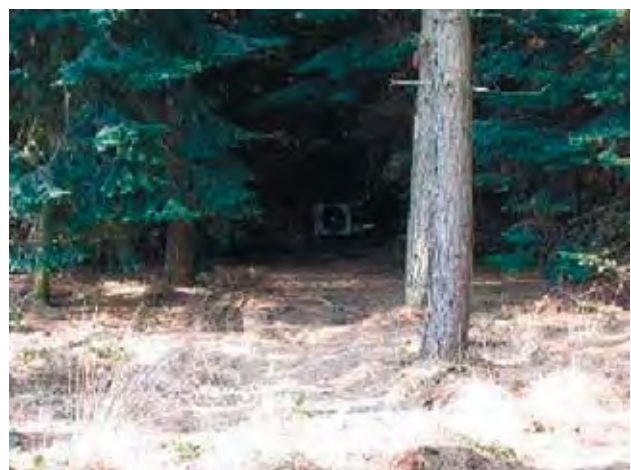

Use your imagination and improvisation to set up a training course that covers a lot of the aspects a field archer has to cope with.

### ***Indoor or off-season training***

Whereas field archery in many countries can be shot all seasons, there are also countries in the world where it is season bound and where preparation for the coming season, has to take place indoors. Indoor practice will mainly consist of technical training.

Although all rounds in field archery have a lot in common concerning training methods in natural surroundings, we do have to be aware of the different disciplines.

After the field archer has mastered the basics of shooting we start individualizing the key elements of field archery such as range finding, in which the coach will find a lot of challenges. It is the task of the coach to offer the tools and the means to use them so that the archers can develop individually in all aspects of field archery.

During the off season when the weather conditions are such that no shooting can take place in the field, indoor training facilities will be required to practice for the next field season. Depending on the local indoor facilities you have a regular sport complex or a factory hall at your disposal. Use your imagination and improvise to set up targets, always bearing in mind the safety aspects. A target can be placed at higher level or even at ceiling height by means of a pulley construction. Be sure to secure and protect the target at all times. Remember that archers have to retrieve their arrows, so make the pulley construction reliable and strong.

### ***Practical training tips for the off-season indoor sessions***

- As the stance is the basic for body alignment and consequently for a good shot, let the archer practice all possibilities that we meet when shooting in a natural surrounding.
- Always start a training session with a warm up. Make the archer aware of the fact that the warming up procedure on the field can be interrupted. After the regular warming up and before starting the competition, the archers are taken into the field to their target. It may take up to 30 minutes before the competition actually starts so that the archer must also do a small warming up at the starting target. During the day it can happen that, while rotating from one target to another, the

archer has to wait because there is a 'jam' which can last half an hour or longer. It is recommended in this case to do a warming up before starting to shoot again. (An elastic band in the backpack is recommended).

- Let the archer get the habit of watching the target every time they start to shoot so that they get a good recognition of the target and learn the importance of reading information from the target (Like arrow hits left/right/high/low of gold or kill).
- To practice shooting on soft ground we use an inner tube from a lorry tyre, filled with air to approximately three quarters and a strong board placed over it in the middle. Let the archer focus their attention on the target which will distract their attention from the stand. Open and closed stances should be practiced.



- Place a chair with the back facing the target and let archers shoot with one foot on the seat. Observe the body alignment; the standing leg, on which the archer puts the bodyweight, should be in a straight line with the body whilst the other leg is 'resting' on the chair.





- Do the same with the other leg position with the chair facing away from the target. The foot / toes should point in the same direction as the knee to avoid twisting the knee and lower leg.



- Place a chair towards the target and place a strong board on the seat of the chair—a different length of the board will give a higher or lower angle slope, place the chair at different angles towards the target and you will achieve a different view on the target face. Let the archer shoot standing and kneeling to get the feeling of shooting uphill and downhill.



- For practicing non-level positions in the field, place a small board under one foot. Placed under both feet it can simulate shooting on an upward or downward slope.



- Closed stance and open stance should be practiced for field archery. The stance depends on the position of the shooting peg in relation to the target.

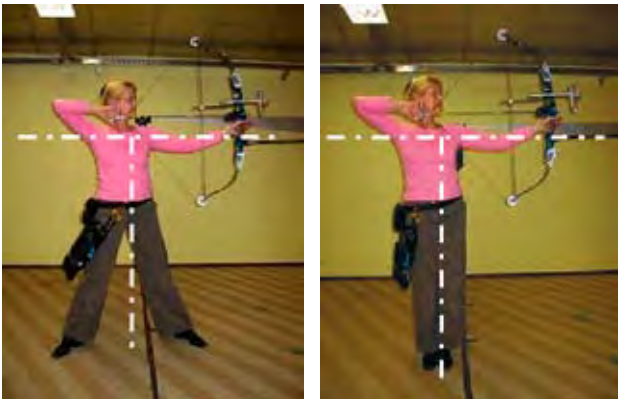

- Let the archers practice the uphill and downhill circumstances by stretching all the way up as far as possible and then come back to straight shooting position when you haven't got a target placed at high position (**Arrows should not be in the bow for this exercise**).
- To simulate shooting uphill you could make use of a target at high level with a pulley construction, downhill can be practiced from a table platform as used by constructors.



- Have archers shoot in different light conditions by turning off the light on the targets and have light only on the shooting position or turn off the light on the shooting line and have only light on the target. Or if possible, have only light halfway to the target.
- Use original field targets or deer.
- Let the archers use their field glasses / binoculars after each shot so that they get used to the rhythm in the field to analyse each shot.
- Make them aware that there are only three shots, or even only one, per target and that the next target will be different all together.

- Lay a rope  $\varnothing 0.5$  cm on the floor from shooting position to target and let archers walk along the rope to practice walking to and from the target in the field.

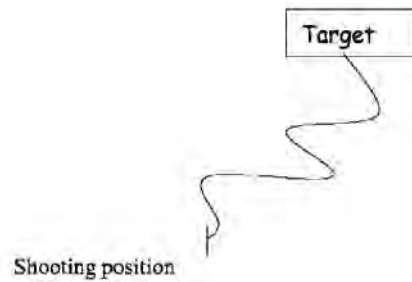

### *Indoor facilities for instruction*

The facilities for the off season instructions for field archery indoor are the same as described in the FITA Level 1 manual chapter 11. Watch safety issues; in field archery the shooting line is not always parallel to the target.

Stands or butts for field archery should be made of light material so that they can be easily transported in the field. A lightweight, portable butt is an ideal target for field archery. Butts should be securely fastened.

For 3D deer you need different sizes of deer, from the very smallest to the biggest.

### *Training for reliable sight marks*

A reliable table of sight marks is crucial for a field archer. The archers can build up this table during practice. In addition the archer learns how much to adjust their sight if they miss the spot by X cm on a certain distance.

When verifying your sight marks on various distances, use the opportunity to shoot also a shorter and a longer distance for each mark. If you are for instance content with your 20 metres mark, shoot at 17.5 and at 15 metres as well as at 22.5 and 25 metres, using your 20 metres mark. Note how much you miss the spot on the different distances. Do the same for every 5m interval. Note the deviation at each odd distance. These notes will show you how much you would miss the spot if your sight setting was wrong. Study your figures and note that if your sight setting is too long, you will miss the spot less than if the sight setting would be too short. Elite archers use this in their advantage, by calculating their aiming a little bit high in the spot.

It is also a fact that poor shots have the tendency of hitting low rather than high. So if you trust yourself, your table of marks is based on the upper part of the gold and you stay brave on your marks.



If your archers are unable to confirm their marks before a competition, you can use a monogram or table of extrapolation that gives many marks, provided a 20 or 30 metres mark as well as a 60 or 70 metres mark is available.

### **Practicing on site**

Start every training session with a warm up. Make the archer aware of the fact that the warming up procedure is somewhat different for target archery (not the exercises, as mentioned before on indoor practice) because after the regular warming up and before starting the competition, the archers are taken into the field to their target which may take up to 30 minutes before the competition actually starts so that the archer must do a small warming up at the starting target. It can also happen that during the day, while rotating from one target to another, the archer has to wait, maybe several times, at a certain target (s) because there are more groups waiting for their turn to shoot which can last up to 30 minutes or longer then it is recommended to do a warming up before starting to shoot again. (An elastic band in the backpack is recommended).

Advise and check the archer's equipment and clothing, especially the shoe choice.

Before starting the practice session walk around the training course and tell the archers what you want them to do on that particular target and point out the safety aspects of that target and of the whole training field. Tell them to walk in the marked direction and whilst walking they should take care, especially after rainy weather, where to step: not on roots of trees or logs lying in the field.

Appoint an archer in each group who will be responsible for that group concerning safety aspects. In field archery the 'A' shooter is the responsible person for that group.

To avoid loss of arrows or damage let the archer first judge the distance and then advise the coach at what distance they intend to shoot. If the estimation is too long you can correct them.

Let archers make notes during their practice on what they see through their sight so that they can study the situation afterwards. The distances from the rulebook are also a helpful guide in training. A lot of archers have their own 'bookmarks' of the distances of each target or deer.

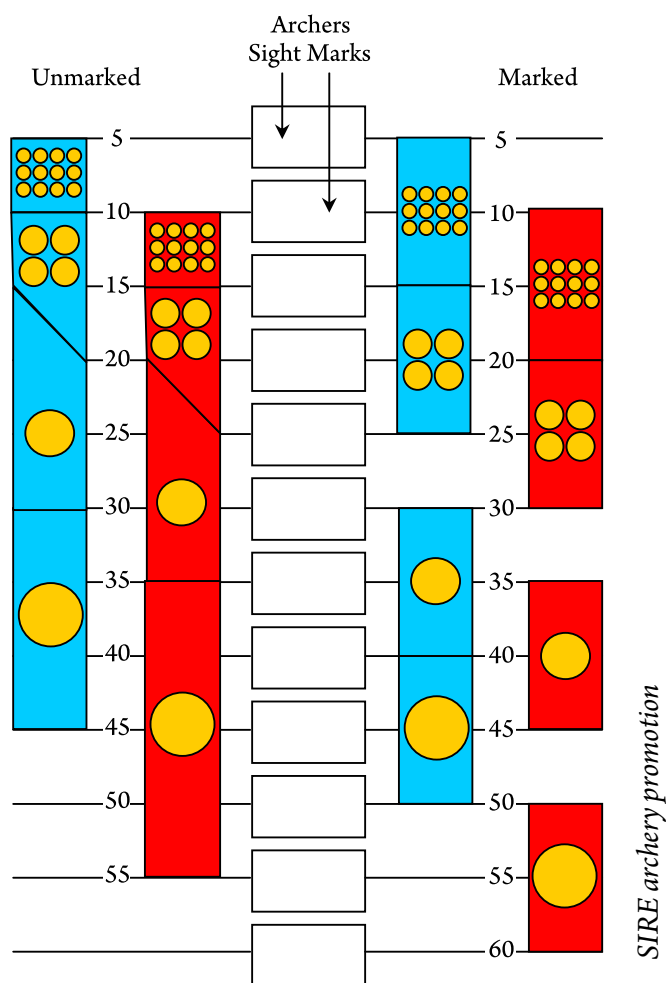

Sunlight will influence archers aiming sideways. Shoot with the sun coming in from various angles, and let archers learn what the consequences are for their aiming.

Wind will influence the arrow flight. Contrary to target shooting this wind may vary from target to target, archers are moving around the course and shoot in various directions. Let archers learn to lean the top of their bow more or less into (towards the direction of) the wind depending on the strength of the wind. This will compensate for the drift of the arrow similar to adjusting the sight sideways, but the archer will not lose their normal centre line adjustment.

### **Shooting across a slope**

When shooting at a target across a slope the probability of hitting on the downhill side of the face is greater than hitting on the uphill side.



The reason for this sideways grouping is that archer is leaning and that the bow is tilted. Archers tend to lean downhill when standing on sloping ground.

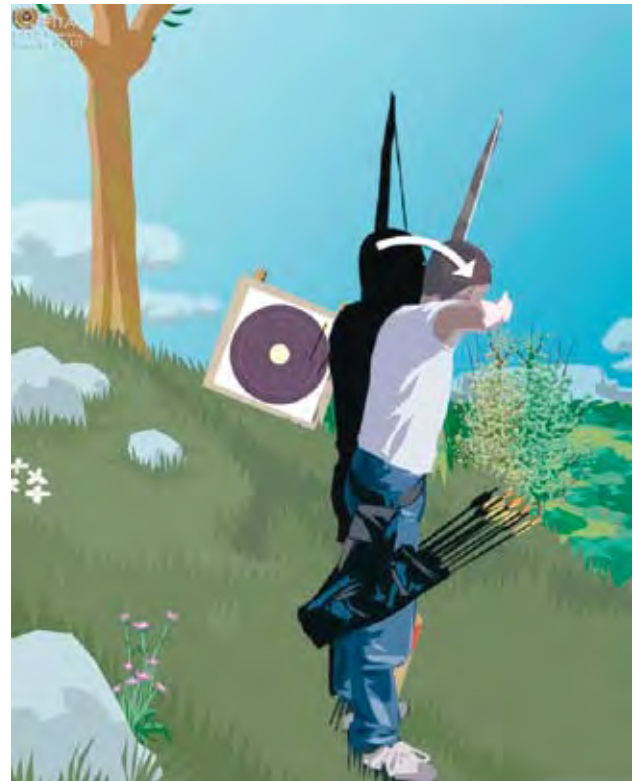

Vertical body position reduces the downhill hitting effect. Archer and coach can check this as follows:

- Try to find a level piece of ground. In competition archers are allowed to move a little behind the line (or around the peg), as long as they do not obstruct their competitor.
- Prepare the shot by leaning the top of the bow towards the hill. At full draw, let the coach check the archer's vertical alignment using the image of the vertical trunk of a tree, or through an imaginary vertical line through the target.
- Line up archer's body in a vertical position, and make sure they are not leaning down hill.
- If the archer is unable to stand in a vertical position and their bow is tilting, they will have to aim a little to the opposite side of their tilt.

When shooting across a slope, teach the archers to start drawing their bow with the tip towards the hill. This will prevent them from leaning away from the hill.

Archers should not adjust their sight when hitting on the downhill side of the target. Let the archer just aim uphill on the next arrow or tilt the bow in the uphill direction.

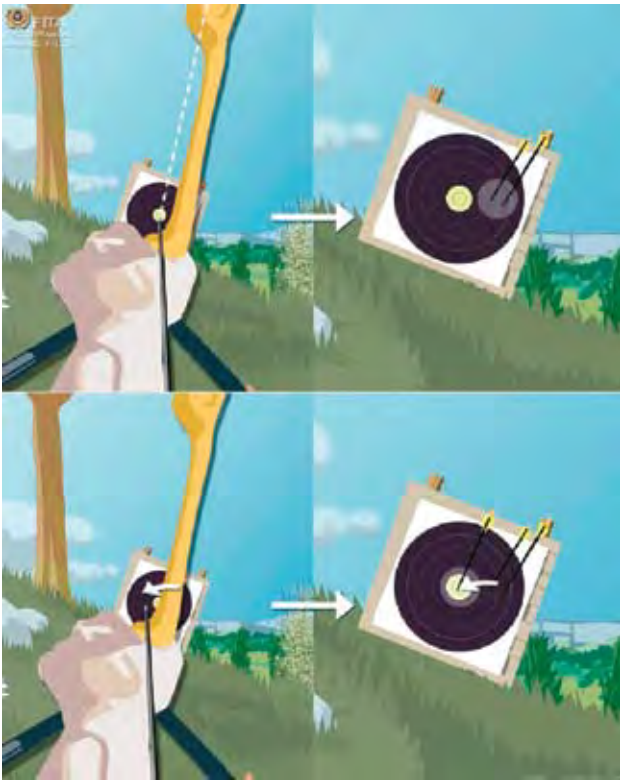

Compound (scope) shooters can of course check their level. Always start by leaning the bow towards the hill. This reduces the tendency of tilting the bow away from the slope.

**Summary of considerations for training in field archery**

In target archery the centre of the target is set 130 cm above the ground and when shooting you are standing with one foot on either side of the shooting line. In field archery you are standing behind the line and often you will have the targets closer to the ground than in target archery, sometimes much higher.

Check your sight marks on various distances with high/low targets.

Let the archers shoot at the target / deer at different angles, from left and from right, up and down. In field archery the targets / deer are not always placed perpendicular to the aiming line of the archer.



Let the archers shoot at extreme angles to prepare them for the actual field tournament.

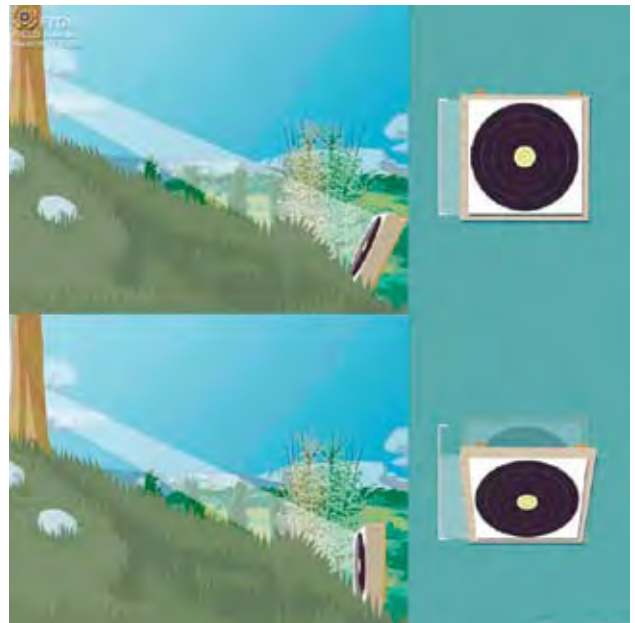

If there is a wind, look at the trees and grass to estimate the wind direction and strength, so that the archer can react to it. Archers must know by experience how much to subtract or add to the distance due to weather conditions



As targets / deer are placed in natural surroundings and only one or three arrows are shot at each target shooting in various weather and light conditions is a must so that archers learn to anticipate them.



Such as: sight setting on all distances in all weather and light conditions, cope with all kinds of wind (constant-wind bursts – wind directions) – add or subtract on uphill and downhill shots with wind or rain–shooting in the direction of the sun (especially uphill) A tip for shooting in wind is to let the archer lick with their tongue the back of their bow hand just before starting the shooting sequence so that they also feel the wind during shooting. Let archers also get acquainted with the rule of the use an A4 paper while shooting in the sun direction. If the sun is shining in the archers eyes which may possibly cause a hazard, a colleague can shield the archers' eyes whilst they are shooting with a piece of paper or card that is no larger than A4 size.

Recognize different target faces / deer and their position in the field (distances), especially the 60 cm and 80 cm target faces. Use different buttresses and buttress sizes so archers can recognize the differences. Also use square and round buttresses. In 3D or forest rounds the archer has to know all (or most of) the deer and deer faces, especially know where the kill zone is situated on every deer or deer target face. A lot of manufacturers have those as a small leaflet. It could also be of importance to know from which manufacturer 3D deer are used during a certain tournament, look at the manufacturer's website to gather information.



Archers should have these leaflets or pictures at hand at any time to look at them or place them somewhere where they can see them when they have time (on the bathroom or kitchen wall may be a good suggestion).







Advise the archers on their clothing especially the footwear choice—walking boots (waterproof) and solid waterproof field glasses / binoculars, also advice on the choice of backpack, food and drinking needs for field archery.

## Chapter 6.

### *Personal care*

The field archer needs to plan for the whole course, decide what kind of food and drinks they need for a whole day of competition, which spare equipment to take along on the field. They have to carry whatever they need through the field them self. As weather conditions can change, they have to learn to experiment with clothing and equipment in order to be prepared for 'everything'.

### *Footwear*

Advise the archers on their choice of footwear, waterproof walking boots. Let archers try out the boots in all kind of weather conditions and with a couple pairs of socks to be used only at training sessions and tournaments. Make sure that the walking boots have a good profile and if the natural surroundings are very slippery due to rainy weather and soft underground the walking boots should have the possibility to attach spikes to them. (Let the archer practice in training sessions with spikes).



Solid walking boots are necessary for a good stance in the field, to protect the ankles (to avoid a sprained ankle) and for a safe walk from one target to another in natural surroundings in all weather conditions. For rainy weather or for high grass boot protection is advisable such as some form of canvas gators may also be appropriate.

### *Clothing in cold weather*

Advise the archers on their clothing for all weather conditions. In cold weather the clothing should be 'breathing' at all times and must not be too loose around the body to avoid string contact. A jumper / sweater of pure wool are very good for field archery in cold weather as wool has the ability to hold the warmth of the body. During rain it becomes wet but will still hold the body temperature.



Gloves are recommended for the periods between shooting. Also a pouch (self made) attached to the archers belt to warm the hands is recommended; there are different kinds of warming devices which can be placed into the pouch and at the same time the archer can keep the finger tab in this pouch.



Trousers with pockets on the side of the legs where the archer can reach them easily are very handy.

### ***Clothing in hot weather***

It is recommended that people on a Field course wear long trousers at all times to protect the legs from insects (flies, ants, mosquito's) and annoying plants like nettle and ivy which could distract the archer while shooting. The shirt should have long sleeves, also to protect the archer from insects and annoying plants. The field archer has one big enemy in the field and these are the ticks. (Although ticks are not everywhere in the world, certain countries have them, your local doctor should be able to give advice on this). From 10° Celsius the ticks settle in bushes and branches. Ticks are parasites that suck blood of humans and animals and transfer contagious infections and illness. So it is of great importance that archers cover their body with sufficient clothing. (It is important that archers check their entire body after a training or tournament for ticks).

### ***Clothing in rainy weather***

Good waterproof wet weather clothing is of importance as the field archer will be in the field the whole day and can not, like in target archery, sit in a tent or go to the car to fetch clothing for differing weather conditions. The field archer will have to decide if they take wet weather clothing along with them at the start of the tournament. It

is advisable to have some kind of lightweight wet weather clothes available.



Suitable is a large plastic (garbage) bag where at the bottom and side holes are cut out to fit the arms and head to be worn over the shooting clothing and under a woollen jumper/sweater.



Also suitable is the tight body fitting clothing which is used in the bicycle fraternity. Let the archers try out their wet weather clothing during training sessions so they know what suits them best and so that they have no unexpected encounters during a tournament.

The archer should consider taking an umbrella. An umbrella is useful for different reasons: keeping you dry if it rains, protection against the sun, as a temporary bow stand and a really handy walking stick for getting up slippery and tricky slopes.

### ***Binoculars***

Advise the archers on field glasses / binoculars. (See the FITA rule book for restrictions). Binoculars should be attached to the belt so they do not get lost on the course and are easily reachable to use.





Train the archers to use the field glasses/binoculars after each shot or even before shooting to gather information from the target face. Even in the out of season indoor training sessions let archers use binoculars / field glasses after each shot so that it will be an automatism during the season. As arrows are shot from different angles at target faces the impact of the arrows are such that the archer may see the arrow nock in the three ring / 8 ring 3DI whereas the point could be in the five/ 10 zone 3DI.

### **Backpack or belt**

Advise the archers on the sort of backpack or belt that would be best for them. A good backpack is a must for field archery as the archer stays out on the field course the whole day without the opportunity to leave the field and fetch something. The archer needs for example up to 4 litres of drinks, food, spare parts and wet weather clothing. A small first aid kit and sprays against insects and sun protection. Some archers prefer a belt, besides the quiver, to carry their needs during the field tournament but most archers prefer a backpack with a seat so that they can sit down during the waiting time at targets.



A good backpack must be waterproof and strong enough to sit on, have different compartments, good shoulder pads / carrying strap. During training sessions let the archers carry their backpack and be aware that they carry the backpack on two shoulders. Carrying the backpack on one shoulder could overburden this shoulder. Let

them make a checklist of what to take with them so that the backpack will not become too heavy.

### **Spare parts**

Decide which spare equipment to take along on the field course. This is an individual matter for the archer but as a coach you have to make the archer aware of their choice and advice them on this matter. A compound archer will most probably take more spare parts into the field than a longbow or bare bow archer. A spare string or finger tab for example is advisable to take along, so is a knife for retrieving stuck arrows from the butt, this would also be good for food matters.

### **Nutrition**

Decide what kind of food and drinks to take along for a whole day of competition. Should we drink water or a sport drink? Nutrition is one of the most important aspects for athletes, which has been recognized since the first competitions in ancient Greece because of the increased need for energy. Field archers, involved in heavy physical activity, need more food than target archers. The energy expenditure of an adult amounts to approximately 2000 – 2800 kcal per day. Physical activity by means of training or competition will increase the daily expenditure by 500 to 1000 kcal per hour, depending on physical fitness, duration, and type of intensity of the activity. For this reason archers must adapt their energy intake by increasing food consumption, according to the level of daily energy expenditure.

This increased food intake should be well balanced. Large perspiration losses may pose a risk to health by inducing severe dehydration, impaired blood circulation, and heat dissipation, leading to heat exhaustion and collapse.

Food and meals to be ingested shortly before and during training, or during a small break between training or competition periods, should be adapted to specific ingestion and assimilation conditions, which depend on the nature and circumstances of our sport. Food regulations exist for foods covering special needs in special circumstances, e.g. dietetic food products. However, no such regulation is available for sport nutrition products/ supplements. Also the different food habits all over the world and the different cultures concerning food have to be taken into consideration. It is therefore the archer that should find the right balance

for food intake and drinking. It has to be tried out during training and competition.

As field archers have to carry their food and drinks for the whole day, the archer should carefully consider what to take; contagious foods cannot be transported the whole day. Advisable are the rich in carbohydrate biscuits. Be careful of drinking out of mountain streams even if the organizers say there is no danger. Again it is up to the archer to see what food and drinks suits them best and the only way to experience that is during an intensive training program and competition. During an intensive training session ensure that enough water is available.

In competition there will be mostly catering points on the course but as a coach assure your self before the competition and ask the organizers if there is a possibility of taking on water in the field. If not, the archer must take with them at least 3 litres of water in their backpack.

Consulting with a dietician along with your archers could be of great help. There are however some basics concerning the food and drink in our sport based on experience of international archers and dieticians from the National teams.

- Have breakfast at least two hours before training or competition.
- Drink only small amounts before training or competition.
- After the first set of arrows drink and eat all day in small portions after each set of arrows. Remember if an archer gets thirsty or hungry during the training or competition it is too late, they are already dehydrated, and it could influence their concentration.
- Archers need up to 4 litres of water a day especially during competition.
- After a day of intensive training or competition eat a carbohydrate rich meal within two hours. Shortly after the activity the body takes up the carbohydrates more easily than at a later time. A spaghetti or macaroni meal is excellent.
- Be careful with caffeine products such as coffee as they have the tendency to waste body fluid (not to mention the heartbeat effects).
- Do not drink liquid that is too cold.
- If abroad at a competition or training camp do not eat anything that is not familiar.

## Chapter 7.

### *Safety in field archery*

Although serious injuries or accidents rarely occur in the Field discipline you must be ready to deal with them if they occur. Field archery is mostly shot in natural surroundings which are mostly outside of the built up areas of cities or villages. Practice mostly occurs in small groups on different targets on the Practice Field which may not be accessible all times. Training is not always on a Field course set out by a club it could be that you decide to shoot in a special place for more steep shots. It is therefore important that you have with you, at all times, an Emergency action plan whilst conducting or taking part in training sessions. Each different Field course should be examined and an emergency plan formulated. During competition the archers must adhere to the safety guidelines but it is the organizers that are responsible for the overall safety procedures.

### *Planning*

Plan your training sessions well in advance, whichever location, so that you can inform the authorities, land owner, game warden and so on, and make your emergency plan for each course:

- Plan and organize training sessions with safety in mind.
- Make a distance layout for each field bearing in mind all safety aspects of arrow flight.
- Plan all material needs for each particular training session—for example arrow stop nets, tape, signs, first aid kit, different target faces or deer, (and for training purposes only) distance estimating equipment, measuring tape and portable radios etc.
- Plan to have someone at hand each training session that is familiar with using the first aid kit.

### *Facilities*

When training is planned in natural surroundings:

- Secure the field you want to use with signs and tape to keep out wanderers, mountain bikers or even horseback riders.
- Inspect the field of hazardous objects before every training session, especially after stormy weather conditions.
- Inspect the targets before each training session, the target butts / deer should be firmly anchored so that they will not tip over.



- Beware of the safety zones especially with uphill targets before each training session assure yourself that all is free of obstacles, and live stock.
- Have marking tape to mark safe walking paths to each target (mostly clockwise to targets).
- Have reserve target faces laid down behind the targets.

### ***Emergency action plan***

Develop and write down an action plan for emergencies for every field course so that everyone is clear of their responsibilities. It should contain at least the following aspects:

- That at least one person has a mobile telephone
- The telephone number and address of the nearest ambulance, doctor or hospital, write these down before the training starts and keep copy in the first aid kit.
- Keep a record of all emergency telephone numbers.
- Have a record of the telephone numbers from members taking part in the training and of whom to contact in case of an emergency.
- Have a first aid kit at a central point.
- Name and telephone number of the person who is familiar with the first aid kit.
- A detailed plan of the facility where training takes place (distance and target lay out with walking directions).
- A copy for each group in the field.
- Portable radios are no luxury in Field archery and people should be discouraged from using them during training or at tournaments.
- Make instructions to stop shooting should an emergency arise, for example three loud blasts on a whistle.

### ***Individual safety***

Inform the archers of any hazardous terrain they may encounter during the training session.

- Instruct the archers of their responsibilities and behavioural requirements in the field.
- Instruct the archers that they should not stand close to a cliff edge.
- Instruct the archers to watch where they walk going to a target to score, and when walking on to the next target.

- Going up or downhill instruct archers that they have their equipment in one hand, away from the hillside, keeping the other hand free for safety reasons.
- Instruct the archers to be alert for the unexpected in the field such as wanderers, bikers, dogs, horse riders etc.
- Instruct the archers that they must not run in the field.

### **Group Safety**

All shooting should be under the direct supervision of the coach, or designated person, who will appoint one archer responsible for each group.

- The archer responsible in each group shall give the approval, at each target, to shoot after convincing them self that all safety precautions are taken.
- Every effort should be made to recover lost arrows on the training course.
- Under no circumstances should anyone shoot if someone is on the field near the targets, this also includes all animal life.
- Care should be taken when drawing arrows out of the target, especially when there is an uneven standing area and surroundings.



- When looking for lost arrows make sure a bow is placed in front of the target / deer, or place a person near the target, so that it is visible for oncoming archers to see that the target is not available.



- When leaving the target be sure that the target is secured for the next group.
- Groups will continue to the next target clockwise and keep to the marked walking paths.
- Since all targets may be shot at simultaneously, the walking path should be safe from stray arrows and slippery ground.

### ***Duty care of participants***

It is the responsibility of each archer participating in any field archery event to ensure that the equipment they use is in a safe condition and within the guidelines laid down by the equipment manufacturer and rules of the tournament, and is capable of withstanding the requirements of a field archery course. It is their further responsibility to decline any shot that they consider too dangerous, and report to the course organizer (or judge) any matter that they deem to be hazardous to the health and safety of any participant or spectator. Participants can also be in breach of the duty of care regulations by not adhering to laid down rules and regulations, which result in negligence, caused by their own acts or omissions.

### ***Personal protective clothing***

Field Archery can be a hazardous sport both from the equipment in use and the condition of the course. It is the responsibility of each archer to take whatever steps they deem necessary to ensure their personal safety and protection against equipment failure in addition to the elements of weather and terrain. For juniors, the onus is on the parent or appointed guardians to ensure those in their care are suitably protected.

### ***First aid***

It is the duty of every course organizer to have a first aid station supervised by a competent person, established to cater for all situations likely to occur. In addition a means of communication must be present, to enable help to be summoned from emergency services such as fire, police and ambulance. This can be in the form of a mobile telephone or two way radio base station, regardless of which, it must be tested by a competent person to ensure that a connection can be made to the relevant Services before the event commences.

### ***Directional signs***

Care must be taken in the placement of the safe path directional arrows. Although not mandatory in law, they are there for the guidance and safety of the archers when they are travelling between targets. They must not direct the archers, or spectators into areas where there is a risk of flying arrows, or an area that may be considered a hazard due to the terrain. If needed, extra directional arrows should be used, and an alternative route sought to guide those persons away from any hazard, but keeping them within the course boundaries. Where an alternative cannot be found, the targets in the area concerned must be relocated accordingly.

### ***Lost arrows***

Every effort should be made to recover lost arrows on the course. If they cannot be found, the course organizer should be notified accordingly giving the target number where the arrow was lost, and the approximate area in which the arrow (s) may be. An archer can also write these notes on the target face, at National level tournaments. At the earliest opportunity, a concentrated search should be carried out to recover any arrows, so as to reduce the possibility of injury at a later date to either pedestrians or livestock.

## Chapter 8.

### *Tactical considerations in field archery*

The basic principle to learn and obtain tactical skills in field archery is constantly repeating the activity under different circumstances. Alter the shooting rhythm (in the one arrow sequence as well as in the three arrow sequence) to use the calm moments.

Role playing of different field competition situations (shoot offs) visualization of a field competition situation.

### *What do I need for a field shoot?*

Below is a short list of essentials for a field shoot, they are in no particular order but are essential for archers own sanity and enjoyment. Bear in mind that the archer is on the field course for the most of the day and that they have no opportunity to leave the course until the end of the tournament.

- The same archery equipment the archer uses for target archery, including the same arrows the archer would normally use, take at least 8 on the course, including a small repair kit to make small repairs if necessary.
- A light snack to eat is always welcome.
- Some local currency coinage, this is to buy some snacks at the stops on course (if available).

### *Specific Field archery awareness and considerations*

- Light wind can cause the arrow to stray sideways (reaction: aim left or right or tilt bow left or right)
- When in open terrain, look at the trees and grass to measure the wind strength so that the archer can react to it.
- In valleys there could be a light wind causing the arrows to drift left or right, (reaction: react against the wind direction or set sight).
- Rain will make the arrow strike lower in the target (reaction: aim higher or set sight lower, keep finger tab-bow and arrows as dry as possible).
- In very high temperatures the efficiency of the bow limbs may be affected and the arrows may react slightly weak, for right handed archers the arrow group will be hitting to the right, (reaction: set the button a little harder and try to keep the complete bow in the shade).
- With low temperatures the arrows could react stiffer and for right handed archers the groups will hit to the left (reaction; set the button a little weaker)

- With strong light coming from the side the arrows will group on the same side the light comes from, (reaction: set the sight or hold on to right or left of the target).
- A slanting/sloping horizon or a slanting target causes the arrow grouping to be left or right depending on the slope angle (reaction: tilt bow – the arrow will follow the top limb, cant the bow left–the arrows will go left and vice versa).

### *Preparations for the field rounds before the opening of the field season*

- Setting goals for the coming season.
- The archer should have an ongoing training plan which includes all aspects like power-endurance-mental-technical.
- Practice should be held on regular basis.
- Practice with all weather clothing.
- Archers should try out all aspects of individual nutrition (food and drink) needs.
- Preparing and planning the participation in certain rounds.
- All equipment, nutrition and clothing must be checked.

Target practice is absolutely essential, prior to the start of the Field season.

### *Tips for the coach*

- Give a good example as a leader and as a coach.
- Give orders and explanations in a clear and precise way.
- Organize your training efficiently.
- Correct errors efficiently and in a friendly way.
- Be enthusiastic and interested.
- Be aware of safety at all times.
- Share your interests with all of your archers.
- Be careful with conclusions.
- Give trust to each other and have respect for each other.
- Be tactful when learning something new.
- Beware of things that can distract the attention of archers.
- Have a whistle with you to stop shooting immediately should the need arise.
- Treat the natural surroundings with respect.



FITA  
Coach's  
Manual

**LONGBOW**

Module

Intermediate  
Level



# FITA Coaching Manual

## Intermediate Level

Module

### LONGBOW

Contents

<b>Chapter 1 Equipment</b> _____	3
<i>The Bow</i> _____	3
<i>The String</i> _____	3
<i>The Arrow</i> _____	6
<i>Quivers</i> _____	7
<b>Chapter 2 Target shooting</b> _____	7
<i>Dominant Eye</i> _____	7
<i>Arrow Length</i> _____	7
<i>Preparation</i> _____	8
<i>Holding the Bow</i> _____	8
<i>Mark on the Bow</i> _____	9
<i>The Hold on the String</i> _____	8
<i>Point of Aim (P.O.A.)</i> _____	9
<i>Archers Paradox</i> _____	10
<i>The Loose Point</i> _____	10
<i>Making the Shot</i> _____	11
<i>Recovery of Arrows</i> _____	12
<i>To Hold or Not to Hold</i> _____	12
<i>Methods of Coming to the Loose</i> _____	13
<i>Change of Distance</i> _____	13
<b>Chapter 3 Shooting Styles</b> _____	14
<i>Clout shooting</i> _____	14
<i>Field Shooting</i> _____	16
<i>'Gapping' to Aim</i> _____	16
<i>Rovers</i> _____	16
<b>Glossary</b> _____	17

**Note:** Within this document we use the term “loose”; this is because during ancient times the command when shooting a longbow en-mass was “nock – draw – loose” and the term “loose” has stayed with the longbow ever since. In modern day archery the term “release” has replaced the term “loose” but I hope you will enjoy the document and accept the term “loose” within.

## Chapter 1 Equipment

### *The Bow*

This is made of wood or laminates of wood. Its belly is to be of a 'D' shape cross-section, the depth is not to be less than  $\frac{5}{8}$ ths of the width. The back must be flat or slightly convex and the sides convex. The handle is about 5 inches (125 mm) long in the approximate centre of the bow and may be covered in any material of your choice. The length of the bow may not be less than 5 feet when shooting arrows up to 26 inches long and not less than 5ft. 6 inches when using arrows longer than 26 inches.

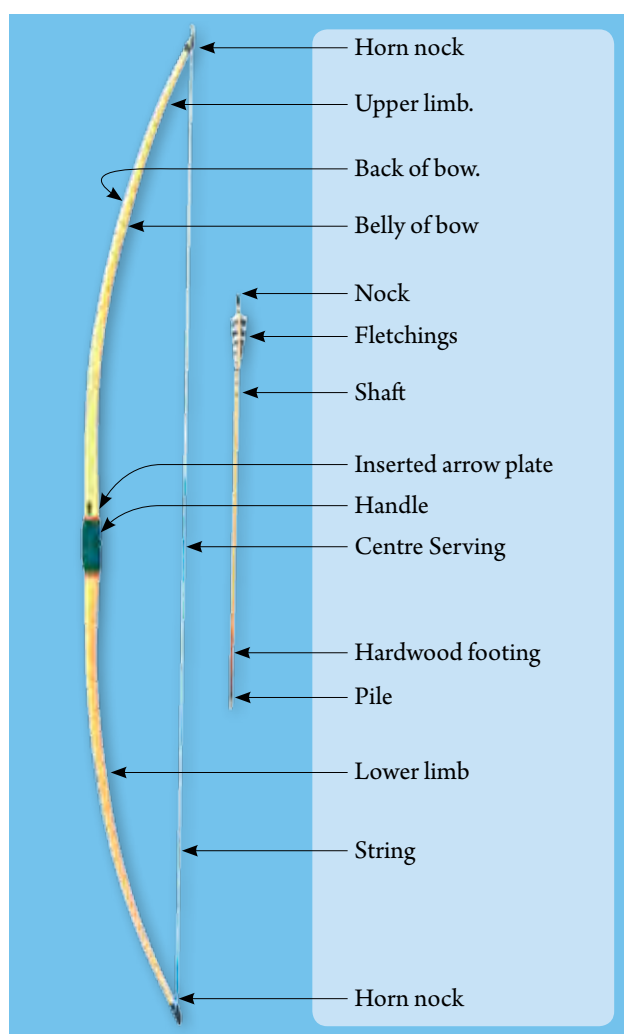

When a bow is made, the bowyer tries to use a well seasoned wood, even so most bows, but not all, will follow the string to some degree. It means that the wood of the bow has taken a set towards its strung position, so that after the string has been let down and the bow is held horizontally, belly down, it looks vaguely like a bird in gliding flight. If the archer holds too long at full draw the set may not only happen quicker, it will probably cause the bow to take a deeper set. A small set taken by a bow may well enhance its use, being sweeter to shoot. A bow that re-

tains its straightness can give a vicious kick in the hand at the time of the loose. My 55lb. self-yew bow went into a small set during its first year and has not increased too much in a further eight years of use.

Among timbers for bow making Yew is most universally agreed upon as being the best, when made into a 'self' bow. Such a bow is made with the sapwood left on to form the back of the bow, with the darker heartwood forming the belly. This arrangement takes advantage of the natural attributes of the wood, which effectively forms a natural laminate, the characteristics of which combine to produce the flexible resistance to bending sought by bowyer and archer. In appearance the self yew bow has a light reddish-brown belly with a near-white back, making it a most attractive item. The heartwood of Yew is also used as the belly of the bow with a Hickory back glued in place which takes the place of the Yew sapwood. Hickory is a hard springy timber used extensively for backing bows. Belly woods, apart from Yew, include Lemon wood, Osage and Beefwood. Although the latter makes a handsome looking bow it fails to stand up to continuous use and is better used in the middle of a triple laminate. Other woods used in this way include Greenheart, Purpleheart and Ash, and more recently English yew. A 'self' bow of English Yew rarely makes a long lasting bow, since the annual rings in the timber are too coarse. Even way back the Yew bows used by the armies were nearly always Spanish or Italian Yew. There are lots of other woods which may be used these may be comprehensively listed in other publications but not always easily obtainable.

### *The String*

The string may be made from any material, traditionally linen, hemp and silk were some of the materials used. However, bearing in mind that a broken string almost invariably means a broken bow, the modern man-made alternatives are safer. Having said that, I have seen only one string break, made of hemp it seemed to break almost gently at the top loop and did not cause any damage to the bow. Better safe than sorry, say I, be cautious over the use of some new materials, choose one that does not have a tendency of breaking too readily, the string may still look perfectly good but be aware of unseen stresses going on within. I have no doubt that a broken string will result in a damaged bow. The new material, Fastflight, is almost guaranteed not to break, looks promising, I have one bow fitted with it for the past year with no adverse affects. The best that can be said for it is, that at 180 yards it

gives about 10 yards extra distance to the arrows. Trying it on one of my older bows gave me the impression that it caused the wood to follow the string more, maybe I was looking too hard for adverse effects. I still think that caution is advised when using modern man-made materials.

At this point it is only fair to tell you why I prefer the double loop string to the single loop. First, I have not made it my priority to become proficient in the making of the latter, though I do use one when making new bows, it is very handy in the tillering stage where the string length has to be altered several times. Also, if the bow is for myself, during the first dozen or so shots I can make adjustments quite readily to achieve the correct bracing height.

Which brings me to the second reason; because of the way it is made the loop cannot be protected with a whipping/serving, so any wearing effect on the loop is taken by the string material, which cannot be good for the string or for the bow should the string break.

The correct length for a double loop bow string is obtained by measuring from the nock to nock along the back of the bow and deducting 2 inches from this measurement. The string, when made, has the allowance for at least the manufacturers recommended number of twists. It is better to have more twists than less – knowledge from experience.

The string is adjusted, by twisting, to produce the correct bracing height for the bow. For most longbows, this will give a 6 to 7 inch (150 to 175 mm) gap between the string and handle of the bow. Traditionally this is referred to as the 'fistmele' and is supposed to be measured using the fist with extended thumb, see figure 1 – this could be a dubious measurement given the variation in human hand sizes.



Figure 1

Although in my early days of shooting the longbow I did have trouble with the bowyers knot, I soon located the reason when I realised that it was in fact nothing more than a straight forward timber hitch, the fault lay in the fact that the inner turns must go with the lay of the whipping along the string ending, I've never suffered slipping since.

### *Making the Knot*

Hang the string from a nail; now take hold of it in the left hand at where the knot has to be formed. With the right hand, take the bottom end of the string and pass it from right to left behind the string, taking the end from the left hand side of the string, leave a smallish loop where the turn has been made, figure 2; now pass the end of the string down through the loop, it is at this point the need is to ensure that the free end of the string is going to lie in the groove formed by the twisted strands of the string, figure 3; having made sure that it is correct, pick up the loose end from the other side of the loop, passing it once again down through the loop, figure 4; a third turn should be made if a heavy poundage bow is used.

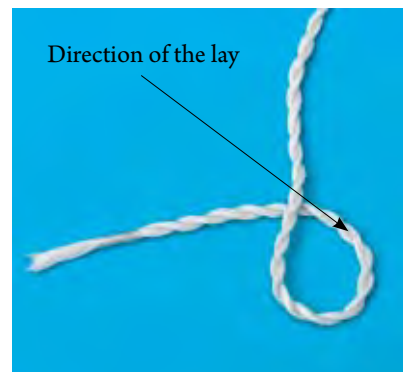

Figure 2



Figure 3



Figure 4

**Note:** It is essential to have the loose end of the string that is making the knot running along the turns of the lay as it is twisted round, and through, the loop to make the knot in the string.

**Nocks**

In the long past the nocks were all self nocks, that is the nock would be cut into the wood itself but, it needed to be strengthened to stop the wood from splitting when the string pressure at the time of the loose was applied. This was overcome by making a short cut down the centre of the end of the shaft parallel to the grain; a thin piece of horn was then glued in. When it is set another shorter cut is made, this time across the grain, still in the centre through both horn and wood. The cut would then be filed out to fit the size of the string of the bow for which the arrow is intended. I was once shown a set of arrows made with self nocks and strengthened with brass, very beautiful they looked too; how they performed I have no idea. Having never seen any like them since I should think they were more for decoration than anything else.

After archery became a sport rather than the fighting method it had been, nocks started to be made as a separate item being secured to the arrow shaft by pinning and/or gluing. They have been made from horn, plastics, aluminium and many other suitable materials. Modern moulded plastic nocks are easier to fit and are in almost

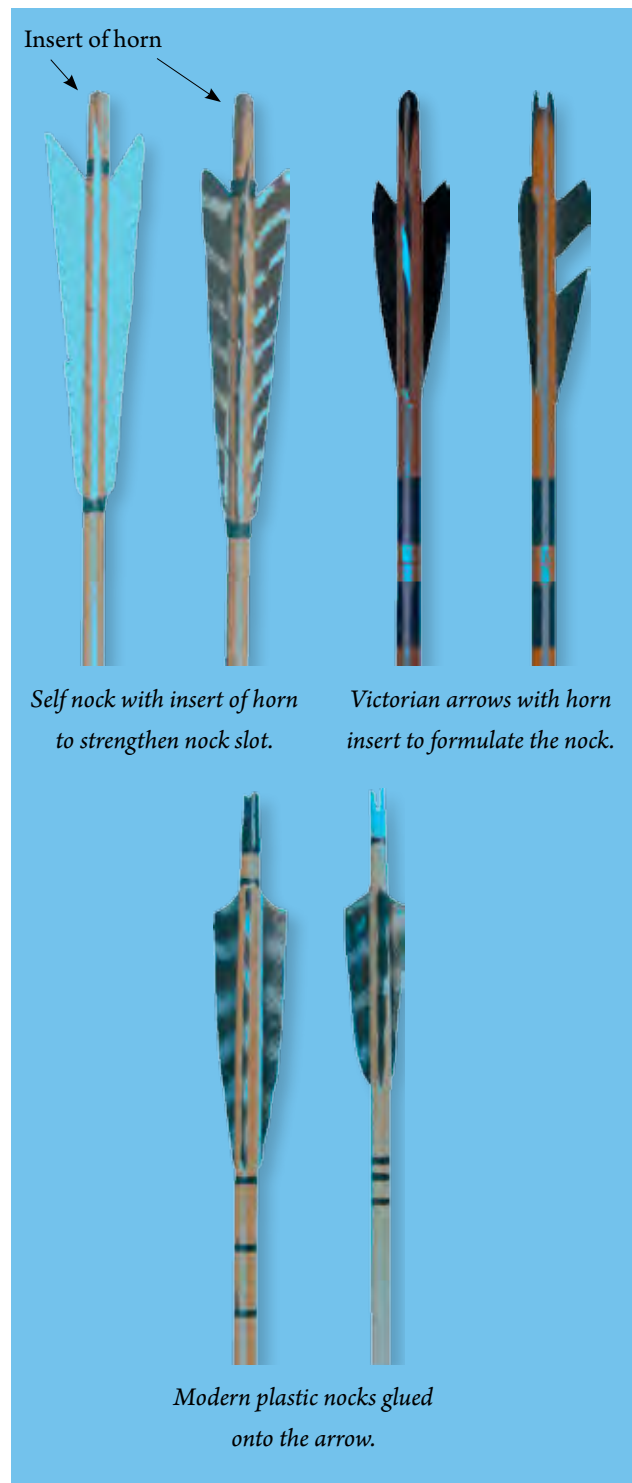

Figure 5

universal use. There are still quite a lot of traditionalists around who prefer to make their own self nocks.

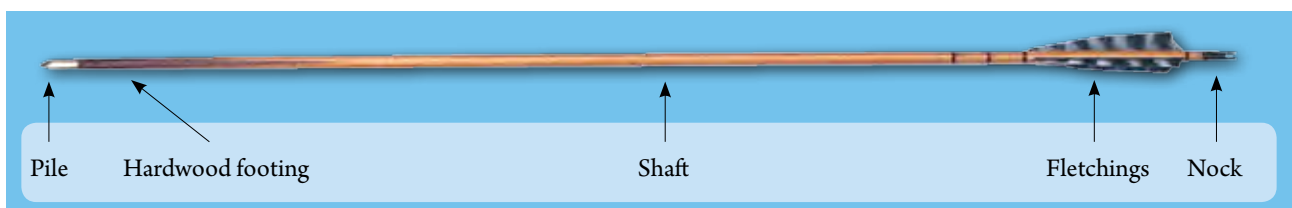

Figure 6



### **The arrow**

This must have a wooden shaft, to which may be fitted a brass or steel pile (point), a nock and with natural feathers as fletchings.

### **Shafts**

The shaft may be of any wood but most are unsuitable, being either, too heavy, too light or too brittle. Arrows made from brittle timber may well break in the bow with disastrous consequences. A fairly light, stringy wood is needed and that known as Port Orford Cedar is used in vast quantities. Arrows made from timber recovered from old floorboards have achieved a kind of mystical acceptance as being 'the best'; certainly the timber will be well seasoned and most probably is of some form of pine.

Self-wood arrows are in the vast majority of use, but they do have disadvantages. It seems impossible to find straight shafts and although one may be told "just heat them up and they'll soften enough to take out any bends"; my experience is that this is often a waste of time that it is just not worth it.

Shooting and spectacular results can be obtained with wooden arrows which are "cheded" i.e. the balance point is to the back and sometimes past the centre line of the arrow. Barrelled arrows can use the same principle of keeping the weight low whilst the spine rating is kept at a reasonable figure.

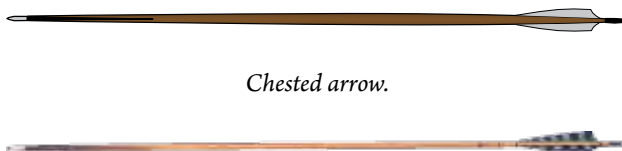

*Chested arrow.*



*Barrelled arrow.*

### **Fletchings**

Fletchings are to be of natural feathers. They can be obtained in various shapes, sizes and colours. There are also left and right wing feathers and never the twain should mix! The usual method is 3 feathers at equidistance spacing around the shaft and at a distance from the nock such that the fingers will not touch them during the loose. When the feathers are secured to the shaft one is at right angles to the slot in the nock. This, the "cock feather", is often coloured differently from the other two and always points away from the bow when the arrow is nocked onto the string. Modern adhesives are very handy for fletching,

as they are waterproof and feathers rarely come off in the rain.

### **Piles**

A fault which can occur with time and use is the weakening of the wood about 1 to 4 inches (25 to 100 mm) from the pile. Sometimes the arrow will recover with a year or so of rest but usually the arrow will "take a set", just as a bow may do, and will not be worth shooting. The old time archers recognised this fault and footed arrows evolved, in which the shaft is fitted with a piece of hardwood for those few vital inches. The hardwood may be Greenheart, Beefwood or even Mahogany but its higher density and weight necessitates compensation with a lighter pile. See figure 7.

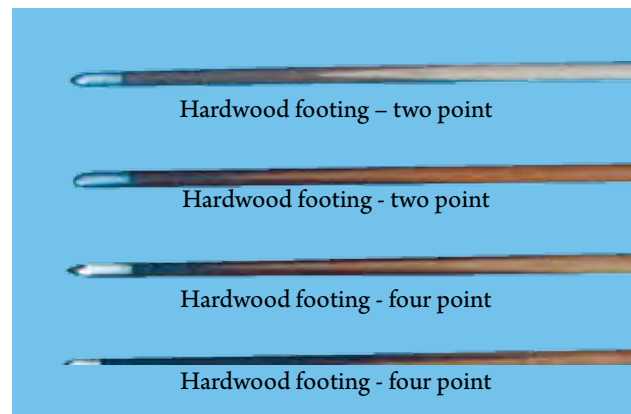

*Figure 7*

*The number of points of the insert depends on the type of joint being used. If a "V" joint is used a two point insert joint will result. If an "X" joint is used a four point insert joint will result.*

### **Spining of Arrows**

Many manufacturers' spine their shafts to suit the recurve bow. For a longbow it is generally reckoned that spine values should be about 1/3rd less, but be careful here; as the user of a 26 inch arrow, shot out of a 55lb bow the spine required is 30/35 group, whereas a friend of mine with a draw length of 28 inches also out of a 55lb bow, uses 40/45 group. The recommendation is, first settle on the poundage of bow needed, and use it with arrows to the formula above until your draw length becomes consistent. Then attempt to fine tune the arrows to the bow.

Shoot several differently spined arrows first, some specialist archery shops used to loan out a set made up like this. When satisfied that the correct group has been found, make up 3 or 4 arrows of that spine or slightly stiffer, shoot one of these at a target set at 40 yards/me-

tres. Also have some medium glass/sand paper with you. Note where the point of aim is in order to hit the centre, if it is well to the right (right handed archers), rub down the shaft but be careful not to damage the fletchings, also keep the rubbing down evenly around the shaft, try again and again if necessary until the point of aim comes onto the target. Not being a centre shot bow it is not necessary to be able to aim at the centre of the target. When you are happy with one arrow proceed to the next. I have found that it is not possible to get some arrows to exactly the same specification; the wood seems to have its own ideas. It is much easier to have some sort of mechanical device to spine arrows once you have one with which you are completely satisfied. Using such a device, one friend of mine measures the depth of bend by rotating the shaft instead of having the grain in each arrow set correctly. I cannot say I agree with this method. Having made up a matched set don't be too disappointed when you find they do not all hit in the same place. The actual weight of an arrow will also have an effect.

If you can afford footed arrows by all means have them but be prepared for some disappointments, they are harder to make successfully than it seems. They have the advantages that the front end stays firmer longer and if the footing breaks it can be replaced.

### Quivers

A quiver is used to hold the un-shot arrows while shooting. There are many varieties of three basic designs, side quivers, back quivers and pocket quivers. Which one you use is a matter of personal choice.

## Chapter 2 Target shooting

### 1) Dominant eye

Firstly determine which the dominant eye is. This is because the dominant eye should be above the arrow nock when at full draw, it is necessary to find out in which hand the bow should be held. Here is a simple and quick way to find out:

With **both** eyes open, point with one finger at a small or distant object, then close the left eye and check if the finger is pointing directly at the object looking with the right eye. If it is, the right eye is dominant, if it is not, the left eye is dominant. As further proof, open the left eye and close the right eye, if your finger appears to point to the right of the object the right eye is dominant, if the finger stays pointing at the object the left eye is dominant.

With a right handed archer the bow is usually held in the left hand, it feels natural in the sense that the left arm would be held out steady, whilst the right hand draws the back the string. So **normally** we have –

**Right eye dominant** – hold the bow in the left hand.

**Left eye dominant** – hold the bow in the right hand.

We often find people who are right eye dominant but are naturally left handed (or vice versa). For these people, at first, try what comes naturally. That should be, I imagine, the bow being held in the “non-preferred hand” (i.e. a normally right handed person will hold the bow in their left hand) using the dominant hand to draw and loose the string. If then the target is missed because the dominant eye takes over, one of two things can be done – a) wear a patch over the dominant eye whilst shooting, or b) change over handiness and learn to shoot the other way round. Many people in fact have learned to shoot, what feels to them, the wrong way round. There are many archer's who shoot with both eyes open, whilst this is desirable some find it difficult to do. Some archers come to full draw then just half close the eye not used for aiming just to be sure the correct eye is the one doing the aiming.

### 2) Arrow length

There are many ways to determine an arrow length for the longbow archer; explained below are two such methods.

a) This is established, at first, by holding an arrow with its nock end against the top of the breast bone and the other end of the shaft between the palms of the hands, stretched horizontally forward. An arrow which reaches a couple of inches (50 mm) beyond the finger tips of the outstretched hands should be a safe length to draw to the chin for a beginner. See figure 8.



Figure 8

- b) A more accurate way is to use a very light weight bow and a full length arrow that is marked off in inches. This arrow does not need to have any fletchings fitted, the arrow must not have a pile fitted—the shaft should be blunt to avoid any accidents. Have the archer fit the arrow to the bow then draw the bow to their comfortable full draw position. A colleague can read off the arrow the measurement that comes to the far side of the bow; then add at least two inches (50 mm) to allow for a safety margin, this measurement can then be used to choose arrows of a suitable length. See figure 9.



Figure 9

### 3) Preparation.

A **bracer** is worn on the bow arm and does in fact brace the clothing out of the way of the string. But, when shooting a longbow its other purpose is to protect the forearm from the lash of the string after the act of “loosing”. This is most important when the archer is a beginner, if the bow arm is not rotated correctly, to give clearance; there is a chance that during the string travel it will slap the bow arm. The bracer can be home made using a plain piece of leather, or may be a purchased plastic or composite material type, or may even be leather reinforced with metal rods; it is secured by buckles, laces or some similar method. The bracer can be seen in figure 11.

A **tab** is worn on the string hand, a double thickness of leather is recommended, at least in the early days of shooting. The tab covers the three fingers used to pull the string. A tab can be obtained that has a non-pinching block fitted between the forefinger and the middle finger. There are also shooting gloves available – these usually cover the three fingers used to draw the string and is attached to the wrist via small straps, but some are now available where all the hand is covered but have leather reinforcing over the first three fingers. See figure 10.



Figure 10

Since no mechanical arrow rest is permitted, the arrow must rest on the upper edge of the bow hand. This means that the point at which the arrow is nocked onto the string becomes both very important and very personal, as too high a nocking point will cause the arrow to come out of the bow erratically, while a low nocking point will result in a cut or grazed hand as the feather fletchings drag across it during the initial moments of arrow flight. I do not advocate the use of wearing a glove on the bow hand as one tends to lose the “feel” of shooting.

### *Holding the Bow*

Take hold of the bow in the hand determined by the dominant eye, with the arm hanging loose by your side the bow should be horizontal to the ground with the string crossing the forearm. The grip should be firm but not clenched. The wrist should be straight, or nearly so. Now lift the bow up vertically in front of you. Take careful note where the handle sits in the hand and check that the bow is the right way up (the arrow plate and, usually, the larger horn nock are on the upper limb). The bow should sit somewhere near the ball of the thumb. This may feel strange but the wrist must not be “inside” the bow during the “loose” because, should the string hit the bracer with the arrow still nocked on, the chances of knowing where the arrow may go is rather slim and it may take some time locating it if it missed the target. See figures 11 & 12.





Figure 11



Figure 12

Note that the top of the hand is level with the top of the handle. It is essential to keep this constant if consistency of the aiming point is to be maintained.

### **Mark on the Bow**

A “mark on the bow” (MOB) is allowed for aiming purpose and this may be a natural mark in the wood, handle of the bow or simply the knuckles of the bow hand. A rubber band (an “O” ring or similar) is the simplest aiming “mark”, as it can be rolled up or down the bow limb to suit the distance being shot. Many archers use the pile of the arrow to aim with but this can cause problems at short and long distances. All bows will be “pile on” at one distance, light poundage bows will be “pile on” at short distances but making it difficult at longer distances, with the heavier bows may be “pile on” at longer distances but making it difficult at shorter distances. The mid-range poundage bows will have problems on both the very short distances and long distances alike. The following describes a way I have heard of overcoming the problem – the archer has three different poundage bows, the most powerful for the 100 yards and the lower poundage bows for the 80 yards and 60 yards. Of course three different sets of arrows are required, as different weight bows need differently spined arrows. There are several ways of overcoming this problem but I prefer the rubber band, which is an aid to shooting, especially repetitively at longer distances, though there are “traditionalists” that frown on its use. If you are used to shooting with a rubber band and then take it off for some reason it may take a few ends to find a good aiming point, but once one has been found it is very satisfying to shoot this way.

### **The Hold on the String**

The forefinger is placed on the string above the nock, the middle and ring fingers beneath, with a clear gap between the fingers and the nock. Many beginners are taught to have the gap below the nock but I found that, in my own

case, it was better to have room above since my forefinger tended to curl noticeably around the nock and press down on it as I drew the bow and the angle between the string and the arrow closed.

It is also necessary to have a deep “hook”; that is to place the fingers so that the string is held in the first joint of the fingers during the draw. This is because, generally, a heavier draw weight is required when shooting a longbow, than in other types of bow, to give a reasonable arrow flight. See figure 13.

Officially the “Mediterranean” grip on the string (one finger above the nock and two below) is the only one used in longbow shooting. I have seen two finger holding and loosing but would not recommend it because of the heavier poundage, as mentioned above, resulting in a greater strain on the fingers which may cause an injury.

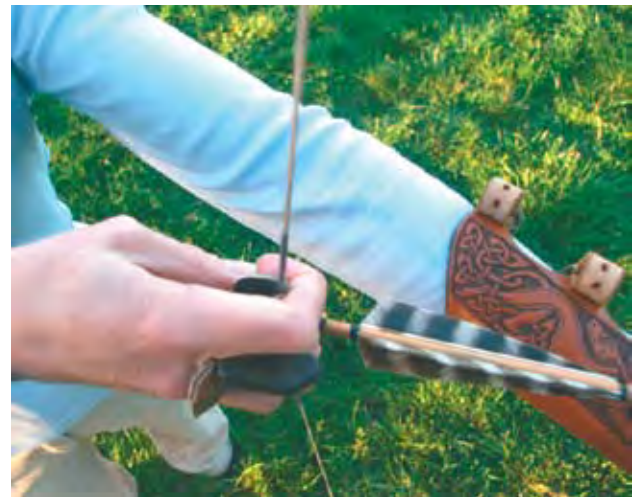

Figure 13

**Point of Aim (P.O.A.).** In order to shoot at a target with some consistency of hitting it we need several things. Everyone would like to be able to aim at the gold but this is rarely possible and some degree of “aiming off” must be employed. One alternative is to aim at a point on the edge of the butt or on a leg of the stand, or even, at some distances, a prominent branch of a tree, a bunch of leaves or some other feature that is in line with your shot. The “mark on the bow” M.O.B. is accurately located on this at the moment of loose. Remember, a longbow is not a “centre shot” bow! This is vividly demonstrated when, having an arrow nocked on the string and the bow hand aimed at the target, the arrow will be seen to point wide of the mark, perhaps even at the target beside the one you wish to hit. Many archers try to spine their arrows to enable them to put their M.O.B. on the gold, to hit it the arrow must go round the bow. Others use a very thick



rubber band, combined with correctly spined arrows, to achieve the same effect. Thick rubber bands are frowned upon, generally accepted is that any rubber band being used cannot be thicker than 1/8th of an inch (3 mm). A few archers, who aim with the pile of the arrow, cant/lean the top of the bow away from the arrow, which again has the effect of aiming at the gold. Correctly spined arrows should always be used. Be very careful if the decision is to cant/lean the bow, for the angle must be as precise as possible for every shot. It may take many years of practice to achieve the effect consistently. A correctly spined arrow should, with the aid of the “archer’s paradox” just clear the bow after being loosed.

### ***The Archers’ Paradox***

At the loose all the stored energy of the bow is applied to the nock end of the arrow via the string and, due to the inertia of the pile, the shaft of the arrow bends, initially inwards toward the bow. As the arrow starts to move forward, the shaft recovers through straightness and bends the other way, reaching a maximum bend as the fletchings slide past the bow. The bending effect dies out quite quickly and a correctly spined arrow will fly straight. It may well “kiss” the bow as it passes, but will have little effect on its flight.

### ***The Loose Point***

In recurve bow shooting “the loose point” is known as the anchor point but in general terms longbow archers do not hold for long enough to call it an anchor point. In target shooting the generally accepted point of loose is from under the chin/jawbone. One way is to bring the upper finger under the chin/jawbone, still drawing back until the string touches the chin and nose simultaneously, then immediately or with minimum hold, straighten/relax the fingers allowing the string to pull off the fingers. Do not try to unhook the fingers from the string. See figures 14 and 15.



Figure 14



Figure 15

Another way, again the upper finger comes under the chin/jawbone, this time the string is brought to the side of the chin/jawbone and loosed as before. A “kisser” on the string is allowed as long as it is not used as a sighting aid and must not be in line with the eye and target. A “kisser” is a special sort of button fitted around the string tight enough not to slip about and is used at longer distances. Its position on the string is found by experimentation. During shooting the hand is brought back a few inches or more below the chin/jawbone and the kisser is positioned between the lips before the loose. Be careful here, injuries may result if the “kisser” is not fitted correctly. By using this method a “pile on” or point of aim (P.O.A.) near the target is possible at least, at 100 yards. Yet another “loose” position is with the tip of the index finger touching the corner of the mouth. This, combined with a canted/leaning bow is used extensively in Field Shooting and is really only for shorter distances, possibly up to 60 yards with a moderately powerful bow. A bow like a tree trunk would be needed to shoot 100 yards with this particular style.

### *Making the Shot*

With bow in hand and arrows in the quiver, the archer stands astride the shooting line, feet comfortably apart, bow-arm shoulder presented to the target. The bow is now brought round to the front of the body, held at a comfortable angle to enable an arrow to be “nocked” onto the string.

**Nocking on:** take an arrow about two inches (50 mm) below the fletchings, bring it up and over the bow, resting it on the uppermost finger of the bow-hand and firmly nock it onto the string at the nocking point. This point is approximately  $1/8$ th to  $1/4$  of an inch (3 to 6 mm) above a right angle from the string to the top of the finger the arrow is resting on. The cock feather must be pointing away from the bow at a right angle. Now the fingers are carefully hooked onto the string – remember, it’s one finger above, two fingers below the arrow nock and the fingers not touching the nock of the arrow. See figure 16.



Figure 16

Still standing comfortably, head upright and looking straight ahead, the bow arm is moved back to the side, bow vertical. Now, if the shot is not going to be made with both eyes open close the non aiming eye and turn the head toward the target. Locate and concentrate on the selected point of aim (P.O.A.). With the bow arm straight (extended) but not locked at the elbow, draw back the string steadily. The bow-arm does two things, resisting the pressures from the string and raising the bow toward the point of aim (P.O.A.), all these actions are simultaneous. When the point of aim (P.O.A.) and the mark on the bow (M.O.B.) are together there should be about 1 inch (25 mm) to go to the loose point. Keep the drawing of the string going, as soon as the string touches the chin and nose, and with minimal hold relax the fingers, the kinetic energy built up in the wood of the bow will pull the string off the fingers; the drawing hand, with the weight relieved will fly back at least to the neck under the ear. The bow-arm is held still pointing toward the point of aim (P.O.A.) until the arrow is flying toward the target. See Figures 17 and 18.



Figure 17





Figure 18

### ***The Recovery of Arrows***

The archer should not go blindly, nor run up the course regardless. There are rules which must be observed. When shooting in the company of other archers, all must wait until everyone has shot all their arrows, those finishing first must step back from the shooting line. It is courtesy when shooting with a companion, to stay on the line until both have finished shooting and then step back together. Usually at organised shoots a field captain will give the signal to advance to the targets to score and retrieve the arrows. In practice shooting it is by mutual agreement, unless one person has been nominated, who is answerable for all deviations from safety. When moving up the course, everyone must walk – do not run; and be keeping a lookout for arrows that have fallen short. It is the custom in archery that if an arrow is damaged or broken by some accident, the perpetrator is expected to offer to pay for it. On arrival at the target the scorer proceeds to record the scores, when nominated each archer calls out their scoring arrows in turn. The arrows are called in batches of three and in descending order – i.e. 9, 7, 5, the archer will pause and the scorer calls them back as the scores are recorded, if there are more arrows to record the archer calls their value – i.e. 5, 1, miss, the archer will pause again and the scorer will call them back as they are recorded. Note that arrows that have missed the target must be called and recorded. No arrows can be removed from the target until all arrows have been scored and recorded on the official score cards. Also, any arrows that have missed the target should not be retrieved until the scoring routine has been completed for all the archers and that target.

To withdraw an arrow from the target: If standing on the left side facing the butt, the back of the left hand is placed close to the arrow which is to be withdrawn, the right hand then holds the arrow close to the target as possible, and in one smooth movement the arrow is removed from the target. Do not twist or wiggle the arrow about

while pulling it free, it causes stress to the wood fibres, weakening them. There is another point to watch out for when taking hold of the arrow shaft, the emphasis must be on the fingers, if the heel of the hand is pressed against the wood, sometimes an alarming bend is caused to appear in the shaft, with arrows that are not very old this does not seem to do any harm. When it is one of your arrows being withdrawn, with your permission, of course, the bend can look very alarming. The reason why the back of the hand is placed on the target face, it has turned into a handy receptacle to hold the withdrawn arrows. Also, another courtesy is extended here, if a fellow archer cannot find an arrow that missed the target then everyone on that target joins in the search.

When returning to the shooting line after retrieving the arrows “no one takes up position on the line” until all archers are back behind it, then and only then, will the Field Captain or nominated person give the signal to recommence shooting.

### ***To Hold, or Not to Hold***

Holding a longbow at full draw is detrimental to the bow. There is an old saying “when a bow is fully drawn it is nine-tenths broke”. When a bow is being “weighed” that is, calibrated to find the poundage at the draw length specified, if that bow is held at its maximum recommended draw length, the poundage reading drops quite quickly during the first one and a half seconds, then the loss lessens to where at about two or three seconds further loss is hardly noticeable. The loss varies according to the initial poundage, more with a “heavy” bow, less with the “lighter” bows. There are many good longbow archers who exploit this phenomenon and hold long enough for the first rapid loss to slow, meanwhile holding the point of aim (P.O.A.) and, when ready “loose”. I should think the loss may be two or three pounds with a 60lb. bow to about one pound on a 35 lb. bow. This is just estimation; I have no real means of checking as different woods respond differently to differing draw weights and draw lengths. What I do know is, when the wood is young (a bow is made from seasoned wood, so let's say “young” in the sense of a newly made bow) the wood recovers quite quickly but an archer who holds at full draw must expect the average bow to quickly follow the string and, from then on, lose power. This is hardly noticeable at first but two or three years of fairly regular use will show its effects. Some archers who hold, and maybe a few who do not, unstring the bow between ends in an effort to delay the wearing effect

of holding at full draw (an end in longbow archery is 3 arrows as many shoots are conducted shooting two way i.e. targets at both ends of the archery field, the archers shoot three arrows, go forward to score and retrieve the arrows then shoot back down the range to the other targets which are just behind the shooting line they have just left). I have no idea of the effect this continual stringing and unstringing routine has on the wood of the bow but I have heard it said it is as detrimental as is holding at full draw. If it is that bad, why hold at all? The most obvious reason is it enables the point of aim (P.O.A.) to be located accurately and held steady before the loose. Another factor is the string can be controlled. Also, the body may be composed; that is if an archer can be composed at all when holding a heavy bow at full draw. It is your choice. Longbows are no longer cheap or as plentiful as they used to be. Self-yew bows are becoming rare and expensive.

### *Methods of coming to the Loose*

#### *Fluid flow draw*

This is a method of shooting in which the bow is brought from a position just below the point of aim (P.O.A.), up to the point of aim and to full draw and loose in one smooth movement. This I believe is the most efficient method of shooting. When mastered, it enables a heavier bow to be used, which gives a lot more authority to the arrow flight.

#### *The "T" Draw:*

With this type of draw the bow is held with the arm up and forward, with the Mark on the bow (M.O.B.) and point of aim (P.O.A.) held in line and the drawing arm up ready. The string is then pulled back steadily to the loose point, where the fingers are relaxed/straightened and the hand and arm carry on backward, all completed in one smooth movement called the "follow-through".

There may be some variations on both methods. Both are used with the hold type of shooting. Most "holders" do so for about two and a half seconds, never more than three seconds. Whatever method is chosen it must be practiced to perfection. It is no good picking up a long-

bow once a week and expecting to become proficient. Anyone who says they have only shot their bow once since the year before then goes on to win is, in all probability, bending the truth, or playing at gamesmanship with applying psychology.

Practice at short distances at first – 15 yards/metres is about right – then, when feeling happy about your improving skill, move the target further back by about 10 yards/metres. After that try shooting 40 yards/metres, your first "real" distance. Later you can try a few arrows at 60 yards/metres, or 80 yards/70 metres, or even 100 yards/90 metres, just to get the idea of what it feels like to shoot at longer distances or just to see if the bow will propel arrows that far. Even when you feel you are proficient, it helps many aspects of your shooting to practice at shorter distances, say 40 or 50 yards/metres. This can boost your confidence, polish your technique and help you sort out your best arrows.

### *Change of Distance*

This can be the most difficult technique to master. Unlike using a modern Recurve bow, where in the vast majority of cases the bow is held long enough to assume "**unit aiming position**", then still held long enough to steady the sight on the gold. If a longbow were to be held, if at all possible, then one or two disastrous things could happen. Either the archer would be left with just the handle in their hand, with the rest of the bow at the feet, or, at the loose the arrow would just creep out of the bow and flop somewhere between the shooting line and the target.

**Unit aiming**, which mentioned above, requires a little explaining. The bow is held with the bow arm at a right angle to the body, using the "T" draw method, the bow is then fully drawn to the loose point and held. The body thought of as a little "t", is then pivoted at the hips backward away from the target, until the mark on the bow (M.O.B.) /sighting point is on your aiming mark i.e. the gold, then steadied before loosing. The first part of the fluid flow method, that of drawing the bow, can also be used, because it still looks good, that a little heavier poundage bow may be used. See figure 19.





Figure 19

Now back to the change of distance when shooting the longbow. Most longbow archers raise the bow-arm to give the arrow a high enough trajectory to reach the target. Unfortunately, when raising the bow-arm and leaving the rest of the body the same, the draw-length shortens – just a little – which in turn reduces the poundage and length of power-stroke and, therefore, reduces the imparted power into the arrow. But do not despair, all that has to be done is to elevate the bow-arm a small amount to compensate. That is ok for 80 yards for men and 50 yards for ladies, but what happens at 100 yards for men and 60 yards for ladies? The only answer really is to change to a more powerful bow, or a bow with a better cast. There is one method that may help, that is the fluid flow method of shooting. I found that this method seemed automatically to set my body into the correct stance, without the need to hold at all at the point of loose.

There is not a great deal of advice to give but to warn of possible reasons for poor results. You have to think about it. Poor performance is more often than not due to a faulty technique.

**Cast of the bow**, this depends in the first instant on the recovery of the woods, its elasticity being the reason it was selected in the first place. The job of the bow is to propel the arrow away from itself, the faster it recovers the more speed is imparted to the arrow and the greater

the cast. A short bow will naturally recover faster than a longer one and consequently shorter bows tend to have a better cast but, in any case, in long-bow target archery a bow shorter than 5 feet is not allowed.

### Chapter 3 Shooting Styles

#### *Clout Shooting*

Originally the “Clout” was a small piece of cloth placed on a short stick and stuck into the ground, and was for training archers to shoot accurately over long distances. In modern times a similar piece of cloth is attached to a small stick, like a flag, and placed in the centre of a large roundel target marked out on the ground to allow for scoring the landed arrow value. The distance for shooting the modern “Clout” is 180 yards for gentlemen and 120 yards for ladies. The British Long-bow Society rules say that the centre is a small straw butt, a hit on which counts for a “6”. There is also a series of rings marked out on the ground, scoring from the inner to the outer 5, 4, 3, 2, 1 respectively, with a total outer diameter of 24 feet. It sounds big until you try to hit it from 180 yards. In some respects it is an extension of target archery.

Here it is essential to have a mark on the bow (M.O.B.) which, with even a powerful bow, has to be below the handle. The other thing is of course, bearing in mind that a long-bow is not a centre-shot bow (and assuming no wind) the point of aim (P.O.A.) may well be to one side of the Clout. In target shooting, when changing to longer distances, a body-lean backward, or an extra elevation of the bow was needed, to give the flying arrow height enough to carry to the target. The “T” draw method may be used, and some archers using it are quite successful. What usually happens is, with the arm elevated and with a loose point on the front of the chin, it becomes almost impossible to see the Mark on the bow (M.O.B.), the first change can be to move the loose point to the side of the chin. If the mark on the bow (M.O.B.) still cannot be located then move the loose point to the corner of the mouth, indexing it with the tip of the forefinger. I would not advocate a higher position on the face, because naturally when the loose point is higher, the bow arm must be elevated further to compensate. Having mentioned a “kisser button” before, it is possible, if the button is moved up the string allowing the drawing hand to be lowered down toward the chest, that a mark on the bow (M.O.B.) above the handle could be used. Remember the English bowmen in history where the bow was drawn to the “pap”. Unfortunately, as this involves an in-

crease in draw length and an unconventional position, a much weaker bow would have to be used than in ordinary target archery. So, all things considered, a loose point on the chest is not a good style for Clout or target shooting.

The fluid flow method is the one to use and I am convinced there is not a better method, its biggest advantage being that a heavier bow can be used. The loose point can be by the corner of the mouth, or to the side or under the chin. The stance on the line and usual sequence of movements in nocking an arrow and setting the body is similar to that for target shooting, except that the large “aiming off” needed at these extreme distances means that the point of aim (P.O.A.) should be regarded as the “target” for the purpose of “setting the body”.

When the draw is started, the bow arm will for a moment obscure the point of aim (P.O.A.), and it is necessary to have in your mind’s eye a picture of the complete draw action. The bow arm swings up and the body is laid back from the hips see figure 20, or, as I often have to do, by bending the rear leg, see figure 21. Following the reappearance of the point of aim (P.O.A.), merging of the point of aim (P.O.A.) with the mark on the bow (M.O.B.). Reaching the loose point a really fast straightening/relaxing of the fingers, must take place as a smooth continuous movement. The follow-through of the drawing hand should be natural and the finish position held for 1 or 2 seconds.



Figure 20



Figure 21

A little bit of analysis of the above would not come amiss. The stance on the line, that’s OK, as usual. The turning of the body away from the actual Clout toward the point of aim (P.O.A.), is funnily enough one of the hardest things to do, as it seems natural to have the shoulder pointing at where the arrow is expected to land. But the distances involved in Clout shooting considerably magnify the effects of small changes of body angle. It is essential to set up the body for the shot as though the point of aim (P.O.A.) were the Clout, since taking a stance as if aiming directly at the Clout will demand a marked compensatory movement to the point of aim (P.O.A.) and a consequent change of posture. Such a change will inevitably affect the shooting method, which by now, hopefully, is instinctive. You may think that this is being over cautious; you only need to have a small muscle twitch, at the moment of loose, when shooting at even short distances and see where the arrow lands, and compare this to your average grouping.

The lifting up of the bow-arm, drawing of the string and the lay back does not really need any elaborating but the temporary distraction of losing the point of aim (P.O.A.) may be a bit of a problem. Here also the position of the head becomes very important. The head must stay perpendicular to the body, as at the stance, with the eye compensating for the change of angle. The archer must

concentrate on this and, if successful, the point of aim (P.O.A.) will be picked up easily.

You may notice I emphasised a **fast** loose. I have experimented on several occasions, in competitive shoots and came to the conclusion that, although in my case a steadier sort of loose was required at target shooting, at the Clout a faster loose, just short of a “snatched” one, gave better results. The follow-through is quite important. The slightest hint of a forward loose or attempting to “unhook” the fingers will result in an arrow landing short of the scoring area. Having got all that right the only worry now is the wind!

**Cross winds** are a little easier to deal with than a wind blowing up or down the course. If the cross wind is coming in such a way that your arrows are landing left of the expected location, then the point of aim (P.O.A.) should be located further to the right, with the consequent stance alteration, or vice versa should the wind come from the opposite direction.

**Head winds** are a little more difficult to deal with. Because the British Long-bow Society rules are that Clout should be shot two-way, when shooting in one direction the wind may be head on, and when shooting back down the course the wind will be from behind. When the wind is “head on” the tendency, because the arrows are dropping short, is to elevate the bow more and more; but the longer the arrow is in the air the more time the wind has to push it about. Also, if a bow has been elevated above 45 degree, the arrow will drop short even on a calm day. I try to sharpen my technique and induce more power from the bow. With winds from behind, the natural reaction is to correct, lower the elevation to reduce the chance of overshooting.

If you are unfortunate enough to find yourself at a shoot with a weak bow, with the wind coming “head on” and the arrows are not reaching do one of two things; practice improving your shooting technique or experiment with it; alternatively try various ways of shooting to see how far up the course you can get your arrows. Most of all enjoy the outing. Still with the weaker bow and the wind from behind, you may well find you do not need to elevate the bow-arm as high as the norm, as arrows with the wind behind will carry further.

### **Field Shooting**

The shooting of arrows from the bow is basically the same, although the small differences which do exist are important. In fact there are a few archers, who shoot both

target and field archery using their target technique, and some are quite successful.

Both fluid flow and “T” draw styles are used. In the fluid draw method I found that it was best to keep the bow vertical, as trying to adopt the same angle when canting/leaning the bow for each shot, is more than a little difficult! Probably I need more practice! My loose point is at the corner of the mouth using my forefinger as the reference indicator. I did experiment with different styles but in all of them, because the rules specify no mark on the bow (M.O.B.), I used the “gap-shooting” method at all distances.

### **Gap Shooting**

Every archer will find that there is one distance at which they can aim at and hit the target by lining up the pile of the arrow with the centre plus offset of the target. This will vary according to the weight of the bow and the style of shooting used but is usually to be found between 20 yards/metres and 50 yards/metres. As one gets nearer the target from this point, a gap must be estimated to give a point of aim (P.O.A.) below the target centre, increasing in size as the target is approached. Be aware however, the gap needs to start reducing again at a distance about 12 to 15 yards/metres. With the distance further from the target than “pile-on” means allowing for a gap above the target. In the hold method the gap is worked out at full draw but in the instant loose method the gap must be calculated before or during the draw. Both may be effective. Practice and more practice is required. The canted/leaning bow is used in both styles and, of course, the arguments as which is the “best” style will not stop, nor really be resolved. You must just try the different methods and styles to find one that feels right for you. I feel sorry for people who are taught one particular style and stick to it, to no avail, frustrated beyond endurance, they drop out of the sport altogether.

### **Rovers**

This form of shooting was much favoured in the days when archery was **the** sport to indulge in. It is often seen as a form of Clout shooting but is, in fact, “Shooting to a Mark”. In the traditional version of “Shooting at Rovers” a group of archers would wander over open land, shooting at natural “marks”, with the next target being chosen by the archer whose arrow fell nearest to the “mark” that was being shot. Now, as a result of limitations on open space, it is more common to shoot at “marks” set up by the shoot organizers which is still very enjoyable and very rewarding.

## Glossary

### *Archers' paradox*

A dilemma of why the arrow appears to point in one direction but flies in another. It is the result of the flexibility of the arrow under dynamic conditions and the deflection of the string off the fingers during the loose.

### *Barrelled arrow*

An arrow that is fatter in its shaft than it is at the pile and nock ends.

### *B.L.B.S.*

British Long-bow Society.

### *Bracer*

A protection device worn on the bow arm to hold clothing clear of the moving string.

### *Centre shot*

Traditionally made bows (longbows etc.) displace the arrow by half their thickness from the centre-line. Many modern bows are shaped to allow the arrow to be shot through the centre-line, hence "centre-shot bow".

### *Chested arrow*

An arrow that is fatter in its shaft but nearer to the back of the shaft than the front

### *Clicker*

A device that gives an audible indication when the arrow has been drawn to its intended draw-length: Not used on a long-bow.

### *Dominant eye*

The eye that takes over dominance and is used naturally when aiming or sighting.

### *Finsbury mark*

An annual Rovers competition in which the "marks" are pre-selected.

### *Fistmele*

The distance between the bow handle and the string, traditionally equivalent to the width of the archer's fist and extended thumb.

### *Fletchings*

The feathers, glued to the back end of the arrow, acting as "flights" or a "rudder". Most arrows have three fletchings, although some archers use "four-fletched" shafts.

### *Fluid-flow draw*

A method of shooting in which the bow is brought from a position just below the point of aim (P.O.A.), to the point of aim, full draw and loose in one smooth movement.

### *Gap shooting*

A method of aiming, whilst at full draw, in which a gap is estimated between the arrow pile and the target, according to the distance being shot.

### *Guild of Elizabethan Archers*

An archery society that holds an annual shoot, based on ancient rules, in support of archery related good causes.

### *Kisser*

A tactile device attached to the string to assist aiming by ensuring accuracy of the draw. Usually drawn to the lips or similar reference point.

### *Loose*

The act of releasing the string at full draw.

### *Mark on the bow (M.O.B.)*

A mark on the bow, to assist aiming, is permitted under B.L.B.S. target shooting rules. Such a device is prohibited in many Field archery rules.

### *Nock*

This is a slot or groove on the limb tips into which the string fits. The arrow should be held on the string by the nock, without support or interference from the fingers.

### *Nock-on*

To fit the arrow to the string.

### *Nocking point*

A point marked on the string, at which the arrow is nocked on. Usually a fraction of an inch higher than a point square from the string to the top of the bow-hand, on which the arrow rests during the draw.



**Pile**

A metal point protecting the front end of the arrow, investing it with forward weight and ability to penetrate the target.

**Pile-on**

A situation in which the shooting distance is such that the pile of the arrow may be aimed directly at and on the target for a hit.

**Point of aim (P.O.A.)**

A point on which the M.O.B. is lined up to achieve a successful aim.

**Quiver**

Container for arrows used while shooting.

**Shoot**

Verb; describing the act of projecting an arrow with a bow. Note; an arrow is not “fired”; no flame or explosion is involved.

Noun; applied to organised archery competitions e.g. Open shoot, Club shoot, etcetera.

**Snatched loose**

Unsteady tugging on the string to complete the draw. Induced by anxiety, excessive bow-weight or poor technique. Results in poor shooting.

**Spining**

A measurement of flexibility of an arrow under set conditions. An arrow may be “spined” (i.e. selected) to match a given draw length and bow-weight.

**Tab**

A shaped piece of leather, used to protect the fingers from abrasion by the string.

**“T” Draw**

A method of shooting in which the draw is initiated and the shot completed with the bow held “on-aim.”

**Unit aiming**

Similar to “T” draw except that the sequence is broken down into “units”. (1) Preparation (2) Draw, with body upright and bow-arm horizontal, (3) Aim, tilting the body back from the hips to achieve elevation, (4) Loose.

**Weight of the bow**

A measure of force (poundage) to bring the bow to full draw.



FITA  
Coach's  
Manual

**PSYCHOLOGY**

Module

Intermediate  
Level



# FITA Coaching Manual

## Intermediate Level

### Module

## PSYCHOLOGY

### Contents

<b>1. Introduction</b>	2
<b>2. Data banking</b>	3
<b>3. Variability</b>	3
<b>4. Motivation</b>	3
<b>5. Self-confidence</b>	3
<b>6. Goal setting</b>	4
Goals for an exercise	4
Goals for a training session	5
Goals for competition	5
Goals for the short term	5
Goals for the long term	5
<b>7. Frequency of training sessions</b>	5
<b>8. Learning and teaching</b>	5
Methods of teaching	6
Explicit versus implicit learning	6
<b>9. Relaxation techniques</b>	7
Controlled breathing	8
Progressive muscular relaxation	8
<b>10. Mental preparation</b>	8
Pre-performance (pre-shot) routines	8
Instructional self talk	8
Visualisation	8
<b>11. Getting into the state of concentration on the shooting line</b>	8
Social facilitation	9
Focussing attention	9
<b>12. Feedback and pitfalls</b>	9
<b>13. Archery is a game</b>	9
Shooting in bad weather conditions	
Literature	10

### 1. Introduction

*'Mens Sana in Corpore Sano'*

Archery is a game, where a specific routine has to be executed many times: to shoot an arrow into the centre of the

target. To perform this routine with the desired result it is necessary that body and soul (mind, psyche) be in balance. Practice for archers is not only perfecting the shooting technique and keeping the body in a good physical shape; mental preparation of the athlete is equally important.

To practise archery, strength, flexibility and dexterity are desirable; to be successful in competition it is essential that:

- The equipment fits the archer and is well tuned.
- The athlete is in a sufficient physical condition.
- The athlete has a good shooting technique
- The athlete is mentally strong.

When a task has to be repeated over and over again in a modern factory, we use a robot, i.e. a machine that is capable in repeating many times a predefined action with great precision. So in a way an archer should act like a robot. Unfortunately performing like a robot is very difficult for a human being. The human mind is creative and much more complex than the command system of a robot: it can inspire, but it can also hamper the performance.

The central nervous system controls the muscles of the athlete. It is recognized that tasks that have been practised many times over and over again and that have reached a certain level of automation, are executed easier and more precisely than non-routine tasks.

The number of components involved in the human nervous system is uncountable. The human nervous system is a highly complex, sophisticated and effectively integrated network. A change in the mental-emotional state of the athlete is consciously or subconsciously accompanied by a change in the human behaviour.

The human brain is part of the central nerve system; brain activity influences the execution of the shot. All kinds of events that are watched by the athlete and also thoughts that go around in the head of the archer can distract them of the task at hand and disturb the archery routine. Learning to react adequately to relevant stimuli and not to react on non-relevant stimuli is part of the preparation of archers.

In the specific state of concentration an archer is capable to act robot-like. Movement is going by itself, without conscious control, using the global image of the routine that is stored in memory, the relevant information that is filtered from all actual information that is gathered by the organs of sense (mostly the eyes and the ears) and disregarding task non-relevant information such as performance of the opponent and results from the past.

A coach, who is working with a group of archers on a regular basis, gets a special relationship with their athletes. The archer relies on the coach and this implies a special responsibility from the coach's side. It is the coach's job amongst others to free the athlete from all organizational work that has nothing to do with the primary task of shooting arrows.

## 2. Data banking

There is a lot of 'data' that a coach has to record and, at the appropriate time, to retrieve. For each athlete the personal data, as well as the archery results, has to be recorded. Also details of shooting technique and physical preparedness are of interest for use in the future. For a successful cooperation between archer and coach over a longer period of time, planning is needed. It is an important task for the coach to make long term and short term planning and to have evaluations at appropriate moments.

For each training session the coach works out in advance a plan on paper in detail for the activities they want to guide. During the training session the inexperienced coach can consult the plan in order to guide a logical and smooth session. After the training session the coach establishes that they have worked in conformity with the planning or otherwise changes the plan for the next year.

Each coach can draw a 'contract' with their archer, stating the objectives for that archer. The archer signs their contract together with the coach and the coach keeps the contract filed. Evaluation of goals is not too difficult then.

Each archer has to do with data banking too. Tuning parameters such as bracing (or string) height, sight marks and so on have to be written down in the archer's notebook. It is also of importance for the archer to record their objectives in the long term as well as a goal for each competition. Archers should on a daily or weekly basis keep track in their notebook of activities and goals, goal achievement, strategies and goal progress. The archer's notebook should be kept in the bow case as a part of the 'equipment'.

## 3. Variability

A person can accomplish the shooting task in many different ways, using different sets of components of the muscle system. Although not every execution will look and feel like an efficient and beautiful one, the result can still be an inner ten! For the result of a single shot in archery the forces that work on the arrow on release are im-

portant, the way in which the archer uses the muscles is not uniquely determined. For the human skeleton there is an ideal stance. The archer tries to fix this stance of the bones by means of their muscles. In reality, even without any windy conditions, 'fixation' of the body is in fact maintaining equilibrium around this desired position.

## 4. Motivation

Motivation, or the will to perform and to abandon activities that do not lead to the desired goal, is necessary for an athlete to fulfil the long route to the highest platform. To become a champion apart from talent and hard work motivation is absolutely necessary. In competition motivation is sometimes called the 'killer instinct'.

Archers have their own motivation: they do it for fun, for their own sake, for their satisfaction, for sheer enjoyment. This is called intrinsic motivation; it is part of the athlete's personal character.

Extrinsic motivation comes from the archer's environment: financial awards, trips to distant countries, status, medals, and so on. Even a very small amount of money to win can be an extrinsic motivation for a recreational archer. The presence of spectators (social facilitation) is another example of extrinsic motivation.

During a training session, when instructing, the coach must motivate the archers for each exercise to raise alertness and to increase enjoyment. They can use external motivation of the athletes by promising an award for the winner like a free drink.

## 5. Self-confidence

Most important for (intrinsic) motivation is self-confidence; which is a mental property. The athlete must regularly experience success in order to develop self-confidence. In archery, on level 1, the coach manipulates the experience of success by organising shooting at a short distance and by using a big target face. On level 2 the archers themselves can regain self-confidence after some bad scores during a training session by shooting a few ends (on a bare butt) at a short distance, so that the arrows group much closer together.

It is of great help for the archer's self-confidence when the coach encourages the archer by giving positive feedback. Examples of positive feedback are: "Well done!" "Good!" or similar. As a coach try, in a practice situation, not to tell the athlete what they are doing wrong. On the contrary, make some comment about what is done very well and find a task to repeat the exercise with less change for errors.



## 6. Goal setting

The way to a high performance level is a long one, motivation from archer and coach and a lot of (hard) work is necessary. Goals can help to go through this long route; they motivate and improve athletic performance.

There are different types of goals; they can be achieved or missed. Missing a realistic goal is part of the sport. The coach must encourage the athletes to set goals. It is a common mistake for inexperienced archers setting too many and non-effective goals.

Good goals meet a lot of properties. The acronym SMART (ER) is a reminder for some of them. The meaning of SMARTER is Specific, Measurable, Action-oriented, Realistic, Time-phased, Exigent and Recorded.

- **Specific** means that the goal is not too general. Goals like 'I will do my best' are not specific; they are too general and therefore not very effective.
- **Measurable** means that the outcome, i.e. the goal achievement, can be measured in the sense that it can be decided afterwards whether the goal has been achieved or not.
- **Action-oriented** means that the goal describes an outcome of the activities of the athlete. The performance of other competitors should not influence the goal.
- **Realistic** means that it is possible that the goal will be achieved. For a beginning archer it is not realistic to set as goal: 'Next year I will be the world champion.' 'Next year I will have the same results as this year may be very realistic, but it is not challenging. So, challenge is another item.
- **Time-phased.** Time limits given for the goals must be clear. (Short range as well as long range).
- **Exigent.** Challenging goals motivate the archer to work hard to realize the goal.
- **Recorded.** Writing down the goal helps the archer to stay aware of the goal.

Goals can be subjective (e.g. 'having fun') and objective (e.g. 'to win the competition'). A subjective goal is not SMART; it is not measurable.

Goals can be positive or negative. A positive goal puts the focus on success; a negative goal puts the focus on failure. A negative goal tends to change the mind during execution and can harm the performance.

There are outcome goals (e.g. 'to beat a particular opponent', 'a score of 1200'), performance goals (e.g. 'to enter the national team') and process goals (e.g. 'relaxing the bow hand after release').

Outcome goals, although SMART, can be less effective than performance goals. If the (outcome) goal is 'winning', then the outcome is very uncertain if the competitors are of equal level. The archer has at best only partial control over the outcome and becomes inflexible in the goal-adjustment if it becomes clear during the competition that the goal cannot be reached any more. Focusing on outcome goals can distract the athlete, as they tend to worry about the outcome of the event and 'forgets' to attend to their task-relevant strategies.

A process goal orientates the archer to focus during the execution of the shot on a specific part of the shooting routine. An example of a process goal for a training session: 'keep focussed on the relaxation of the wrist joint of the bow arm after release'.

When athletes take part in goal setting they become more involved in the programme and more committed because they feel responsible to some extent for their tasks. Don't force your athlete to set goals if they have a negative attitude to do so.

### Goals for an exercise

When the coach presents an exercise to their pupil during practising it is important to explain the goal of that work out. The athlete appreciates the goal-oriented work out and will be motivated to do their best. The exercise should not be too easy, otherwise it does not motivate; on the other hand, it should not be too difficult, as it could just create frustration or even de-motivation. It must be challenging. Examples of an objective with appropriate exercises:

Objective	Exercise
<b>To improve physical form</b>	We shoot eleven ends, numbered from 1 to 11. In the ends 1 to 6 the number of arrows equals the number of that end. (So in the first end 1 arrow, in the second end 2 arrows, ..., in the 6th end 6 arrows.) In the ends 7 to 11 the number of arrows equals 12 minus the number of that end. (So in the 7th end 5 arrows, in the 8th end 4 arrows, ..., in the 11th end 1 arrow.) 'Shooting pyramids'
<b>Shooting with relaxed bow fingers</b>	Tense and release your bow fingers before shooting; we shoot an end of three arrows with stressed tension on the bow fingers; next we shoot some ends with relaxed fingers

### ***Goals for a training session***

For a training session you can set as a goal to work out with your athletes some part of the shooting routine, e.g. the stance, the bow shoulder, etc. In the coach's plan for this training session you can prepare special exercises for the warming up, which introduce the subject of that session. If, for instance, the bow shoulder will be the topic, then you can conduct in the warm-up part some special exercises for arms and shoulders.

### ***Goals for a competition***

The goal for an archer in a competition should only depend on the archer's performance (and not on the opponents' performance). An archer is not at all capable to influence the opponents' performance.

Before each competition the archer must set a goal. 'Winning' sounds quite nice, but it will not have the positive effects we expect from a goal. The goal must be incorporated in an overall planning for the long term. So, 'winning' is not always what counts. A competition may also be 'training' for more important competitions to come. Example of a goal for a (indoor) competition: 'To shoot the first arrow of each end after 30 seconds'.

### ***Goals for the short term***

A clear goal for the short term prevents disappointment. If the goal for the short term is realistic, then it gives the athlete the feeling that they know what the perspective of their activities are. A recreational archer can do without a goal; it is enough to have fun. For an archer on level 2 and for elite archers goals for the short term play a role in their planning cycle.

### ***Goals for the long term***

A goal for the long term helps the archer to stay motivated. There are examples of some Olympic medallists who, although being a young and ambitious novice, already put as their objective 'I want to become an Olympic champion'. Planning on the long term is marked with goals to be achieved at fixed dates. Once a goal has been identified, it should be recorded by the archer and by the coach. It is not inspiring for the archer if they have to do just what others (the coach) have thought to be good for them, so involve your athletes in setting a goal. An objective for an archer on level 2 for a season could be: 'to shoot all arrows in the yellow and the red (with the possible exception of a miss)'.

Objectives for the long term on which athlete and their coach have agreed serve to motivate their cooperation. The objective can be 'to participate in the Olympic Games', which is very ambitious, or 'to have a nice time during the hours of practice', and anything between.

For the long term (several years) the objective could be 'I want to be among the best in my country'. To achieve such a (middle) long-term plan it is wise to plan this achievement in several steps (years). For each step we formulate a partial goal.

## **7. Frequency of training sessions**

The human body is a complex system with many physiological processes. These processes play a role in sport performance. Through training sessions we try to improve our athletes' level of shooting technique and quality of physiological processes. However, one cannot be training all the time; periods of activity have to alternate with periods of rest. Within certain limits one can choose (plan) when to practice, when to compete and when to take a rest. This is the essence of the coach's yearly planning. The periods of rest are more important than sometimes assumed. Shooting a few hundred arrows six days a week is less effective than shooting a deliberate number (say 80) of arrows three to four times in a week. A heavy training session just before an important competition can become disastrous.

With novices we may have one training session each week. On level 2 this is no longer optimum. Archers should practise a few times per week. It is a fact of experience, that practising archery twice a week is just enough not to forget what has just been practised, so archers on level 2 should have training at least twice a week. On the other hand it is important to give body and mind enough time to recover, which means no shooting for one to three days per week.

The skill of shooting must be well trained. In organising the training sessions it is important that athlete and coach follow a systematically predefined plan.

## **8. Learning and teaching**

Archery is a routine or motor skill, which has to be learnt like writing or driving a car. On entry level we find out what archery is all about; we have 'learnt' archery if we can reproduce the shooting routine with great consistency. This takes years of practicing archery two or three times a week.

If we want to learn how to drive a car, we need a car and an instructor to explain how to use the gear lever, how to master dangerous situations in traffic, etcetera. For archery we need equipment and a coach to teach how to shoot.

On level 1 you have instructed your novice archers to shoot their first arrows. You probably did not interfere too much in their (poor) technique. Your archers got the confidence that you as a coach guarantee safety and their first contact with archery gave them fun. After a while you will conduct your athletes step-by-step to the correct technical execution of the shot. When all the technical details have been trained, coaching continues on a higher level.

Athletes generally follow their trainer's instructions; the coach observes how the archer executes the shot. As long as not all arrows hit the bull's eye, the coach tries to discover what the archer is possibly doing incorrectly. The coach cannot directly observe all the visual and proprioceptor information that the archer collects during the shot nor can the athlete tell that to you.

The athlete's thinking, remembering and considering during the shot determines the outcome of the execution, so it is important for the coach to find out what is going on in the archer's mind.

If in a training situation the archer pays special attention to one part of the routine, then other parts are often badly executed. By asking the athlete "What did you do?" the coach gets an idea about the athlete's mental focus.

As a (quasi) paradox the archer's performance usually drops after corrections in technique proposed by the coach. This can be caused by the attention the archer is paying to parts of the routine that were previously performed subconsciously and that are now consciously executed for some time. This is a normal experience. After a certain period of practising the new movement will be routine and executed automatically again. It is therefore not wise for the coach to suggest changes in shooting style shortly before a competition. Such corrections should be made preferable after major tournaments.

We consider five stages in learning archery.

- s1. Getting the idea of the skill
- s2. Rough coordination
- s3. Fine coordination

\* *A proprioceptor is a specialized sensory nerve ending that monitors internal changes in the body brought about by movement and muscular activity. Proprioceptors located in muscles and tendons transmit information that is used to coordinate muscular activity*

- s4. Refining and performing under various circumstances
- s5. Elite perfection

The athlete has to go through these stages, one after the other. It is the coach's responsibility to keep this sequence in mind. Always realise at what stage your archer is currently learning. In a level 1 course we have to deal with stages S1 and S2. On level 2 we have to work on the stages S3 and S4. Stage S5 is left over for level 3.

An athlete uses different means of learning.

- Feedback of the result at the target.
- Verbal feedback from the coach such as 'well done!' or a comment on the execution of a specific task.
- Non-verbal feedback from the coach such as 'thumb high'. If the coach usually gives verbal feedback, a silence can also be meaningful.
- Imitation or model learning. On level 1 young archers like to copy a popular archer's shooting style, sometimes from a movie. If this 'model' has the perfect shooting style that fits the pupil there is no problem, but mostly it is not advisable to imitate fully another athlete's shooting performance. The coach can use the ability of model learning by showing a posture or movement to the archer. Use a good model (yourself or somebody else) to show the shooting sequence and use a video camera or a mirror to show this athlete's performance.
- Understanding. If we understand that moving the sight pin for example to the left, leads to holding the bow more to the right, we know how to correct the sight if the arrows hit left. We can use standard rules such as 'Follow the arrows with the sight pin'.

### ***Methods of teaching***

The coach can use one or more of the following methods of teaching.

### ***The fragmentation or checklist method***

The shooting routine is divided into a sequence of about 10 isolated steps. These steps are practised with the bow. The advantage is that the athlete can easily carry out these steps separately. The disadvantage is that the archer may continue to analyse all these steps of their acting, which in a stressful situation leads to convulsive movements and decreasing results. The isolated steps may not evaluate into a smooth routine, which is the biggest disadvantage in this method.

### ***The analytic or element syntheses method***

The shooting routine is divided into four or five relevant parts. Each part must be practised on its own and without the bow. After having practised the parts separately, they are put together using the bow. A great advantage of this method is that a lot of mistakes in the shooting technique are avoided. Teaching can be very efficient, with relatively big groups of athletes. It is very difficult in many countries of the world, however, to motivate athletes to practice 'archery without a bow', even when the advantage is evident.

### ***The comprehensive method***

The movement is executed as being undividable. If necessary, elements such as raising the bow arm can be practised separately, but are as soon as possible reintegrated in the overall movement. The comprehensive method of learning can easily lead to a personal shooting style, which could be seen as a disadvantage.

For the above-mentioned reasons we prefer a combination of the analytic and the comprehensive methods of teaching. Don't be afraid that your archers on the 2nd level will make a lot of mistakes. It is part of learning. People learn also by experience. After having been shooting in their own style without a high score, the athlete will be interested to listen to the coach's suggestions.

If the coach teaches an inadequate kind of style, the archer will learn this form and the scores will drop permanently. It is very hard to get rid of an improper style in a later stage.

### ***Explicit versus implicit learning***

In a training session the coach makes remarks on the shooting style of the archers and gives them a task to focus on in the next ends. These suggestions of the coach can be based on explicit learning and on implicit learning.

Using explicit learning, nothing is left to the imagination of the archer; the archer has to do just what the coach describes, the coach tries to stay as close as possible to the ideal technical execution of the shot by the archer.

Implicit learning leaves a lot of things to the archer to discover themselves. If the coach observes that the archer has a collapsed stance, they can use the words "Make yourself tall", leaving to the archer to discover the translation "Stretch your spine, cant your pelvis". Using analogies is another example of implicit learning. For instance the remark "Keep the bow in your hand as if you keep a little bird in it; if you open it, the bird is

gone, if you pinch too much, the bird is dead" leaves to the archer to discover that the bow fingers should be relaxed.

Explicit learning works faster than implicit learning, especially at the beginning of the learning process. Implicit learned skills are less sensitive to stress than explicit learned ones ('choking under pressure') and therefore have a significant advantage above explicit learned ones.

A coach who wants to use implicit learning tries to offer a task to the archer, where the archers themselves to find out how to adapt their technique. For instance you fix an extra target face just above the ground; you tell your archer to pull the bow and to aim on the lower face, not loosing the arrow and to move the point of aim with the drawn bow to the upper target and then release. The archer has to find out how to swing the body around the hips, maintaining the T-shape.

## **9. Relaxation techniques**

Stress is the human process whereby an individual perceives a threat and responds with a series of psychological and physiological changes such as increased mental arousal and muscular tension. For sport performance stress should be avoided.

Arousal may either facilitate or inhibit sport performance. In the absence of arousal high performance is not possible; too much arousal can cause stress. The ability to regulate arousal levels is an important mental skill. Mostly the archer needs to relax; sometimes psyching up is needed to reach the optimum level of arousal. With relaxation techniques athletes can lower their general muscular tension under any condition.

In a situation of a competition or championship there will be increased mental arousal. Relaxation can facilitate recovery during the short time between two ends of arrows. An archer must learn to communicate with their body, i.e. to learn how to self-regulate arousal.

Relaxation teaches the athlete to regulate tension so that the nerve pathways to the muscles are never overcharged. Relaxation also promotes the onset of sleep and reduces insomnia problems that plague many athletes prior to competition. On the other hand, relaxation techniques can also help when the archer is fatigued.

Some methods of relaxation or diminishing a high permanent arousal (stress) are controlled breathing, progressive muscular relaxation and meditation.



**Controlled breathing**

In general archers should have the habit to breathe like a baby does: do not raise your chest too much. A good breathing rhythm has to be an automatism. It is a normal reaction on anxiety to stress the upper breathing instead of using diaphragm (lower breathing). It's actually a sign of fear; yawning and sighing are other signs.

The recommended breathing uses the diaphragm rather than the intercostals (chest) muscles. The conscious effort of paying attention to one's breathing may relieve anxiety: one cannot consciously concentrate on both, breathing and worry. In contrast to upper breathing yawning and sighing are active means to create and/or support relaxation

**Progressive muscular relaxation**

Progressive muscular relaxation can give the feeling of the difference between tense and relaxed bodily sensations by alternately contracting and relaxing designated muscle groups; it can reduce body tensions that harm good execution of a shot.

**10. Mental preparation****Pre-performance (pre-shot) routines**

Watching (elite) archers, you may observe different pre-shot routines. Examples are watching a fixed point anywhere in space before each shot, moving the body weight from one foot to the other (Cf. the three times bouncing of the ball on the ground before the serve by a tennis player), putting your quiver in place (as if it was not already there) and so on. Pre-performance routines provide time for liberation of task-non-relevant thoughts and to focus on task-relevant observations.

Pre-shot routines are executed subconsciously, most archers are not aware of them. Pre-shot routines serve several reasons. They help to make the archer's mind free from all that happened just before behind the shooting line: your all-day talks, the score, all advice you got from different people. Pre-performance routines belong to the shooting routine; a coach should not try to abandon them. Executing pre-performance routines is an archer's personal start to get into the state of concentration.

**Instructional self-talk**

What athletes think or say is critical for performance. Thoughts directly affect feelings and ultimately actions. Appropriate or positive thinking leads to optimistic feelings and good performance; inappropriate or misguided

thinking leads to negative feelings and poor performance.

Examples of positive thinking are 'I achieve my goal', 'I have confidence', and 'I will win this game'. Examples of inappropriate thinking are 'I can not win this game'; 'I will not have a high score to day'.

Anytime you think about something, you are in a sense talking to yourself. Such instructional self-talk can help the archer to keep appropriately focussed in the present, not staying with past mistakes or projecting good results into the future. Examples of instructional self-talk are 'I keep my bow elbow in position', 'I keep my release fingers relaxed' or 'I move my scapula to my spine'.

'If I shoot 28 again in the next end, I break my personal record' is an example of projection into the future, which often does not lead to the desired result.

**Visualisation**

Visualisation (mentally rehearsal of the shot) is seeing and feeling oneself performing a skilled movement (launching an arrow) in one's imagination. Archers may (they actually should) use visualisation in a training session prior to the actual shot. Visualisation just before a shot suppresses non-relevant task thoughts. Visualisation does not offer feedback similar to the actual shot like kinesthetic sensations or score.

In a relaxed situation, an archer may sit down, the eyes closed, and imagine how they go to the shooting line, take the appropriate stance, nock an arrow, focus with the eye on the gold, raise the bow, draw, anchor and complete the shot.

As visualization occupies the mind, it is not a good idea to use visualisation on the shooting line during periods and/or actions requiring a lot of care. A mind free of thoughts is characteristic for the state of concentration.

**11. Getting into the state of concentration on the shooting line**

For a good performance the athlete needs to know how to get into the state of concentration on the shooting line. The major element of concentration is the ability to focus one's attention on the task at hand and thereby not to allow to be disturbed or affected by irrelevant external and internal stimuli.

It is not so easy to get into the state of concentration; you cannot achieve it just 'by demand'. The following conditions have to be fulfilled.

- The archer must be motivated.
- The archer must have one clear goal.

- The archer must feel the importance to achieve the goal.
- The mind has to be free. Temporarily forget everything that is not exclusively involved in your shooting.
- The archer must be physically fit and should not have any (major) injuries. Fatigue or harm causes distraction and therefore hampers concentration.
- The archer must not take any drugs or alcohol.
- Any thought of what might happen in future or has happened in the past must be excluded, only the presence of NOW counts.

### **Social facilitation**

Well-known skills are executed well in the presence of other people; complex or poorly learnt skills are executed worse in the presence of others. Other people can be the opponent, the spectators, the coach or a judge. This is a general phenomenon, called social facilitation.

### **Focusing attention**

Focussing attention sustains alertness and keeps you free from distraction. At the start of the shooting routine the archer has freed their mind from task non-relevant thoughts and things that happen around them occupy the attention. On raising the bow the notice should be focussed on one single point of attention. There are thousands of possible points of attention, specific and internal for the archer such as: my stance, the movement of my scapula, my bow shoulder, my breathing, and outlining my bow, but also general and external such as the effect of the wind. The point of focus is a personal preference of the archer. By directing the attention on one point, all the (other) elements of a good shot could be executed subconsciously, that is in the state of concentration.

‘The focus on the centre of the body’ in Eastern archery literature is equivalent to ‘The state of concentration’ in western terminology.

Relaxation techniques and goal setting can harm focussing and are therefore not appropriate on the shooting line during competition.

### **12. Feedback and pitfalls**

Kinaesthetic sensation is the feeling that the archer has immediately after the shot, even when the arrow has not yet hit the target. Elite archers rely more on kinaesthetic feedback than on visual feedback, i.e. score.

After a perfect end there is little physical feedback: the athlete is not capable to report afterwards what they did right and what they did wrong. The usual reaction is “everything went correct; it felt quite nice”. We do have a pitfall here: the athlete is so excited of their perfect performance, that they are enjoying it in the next end, instead of focussing the mind ‘from zero’. We call this mental pitfall ‘euphoria’.

After a non-perfect end the athlete can easily formulate all the mistakes they made. At the next end they can use this information. However, this is also a pitfall. The focus will not be on the task-relevant elements, but on all the mistakes they remember. They tend to focus in a negative way, trying to ‘avoid’ these mistakes, thinking ‘this and that should not go wrong’. As we have seen before, in learning and teaching, focussing on parts of the shooting routine can easily lead to bad execution of other parts and/or even the whole shot.

### **13. Archery is a game**

The execution of a shot should happen spontaneously and automatically, in the state of flow. Archers should not be concentrating too much on their score. A good coach wants them to perform as comfortable as possible. A nice pace (rhythm and tempo) is more important for the shot than the knowledge about their own and/or the opponents’ intermediate standings.

We can divide the activities of archery into three parts: (technique) training sessions, shooting a tournament and doing some recreational archery. The importance of recreational archery should not be neglected. Informal matches with colleague archers are also considered as ‘recreation’.

Archery should be practised also ‘for enjoyment’. Depending on the circumstances, the elements stance, execution of the shot and score play a different role. There is a relation between these elements and the activities of the archer. In table 1 we show the coincidence matrix of this relation.

**Table 1.** Points of concern in different circumstances:

	Stance	Execution	Score
Technique training	+	+	-
Tournament performance	+	-	+
Recreational archery	-	+	+

Table 1 should be read as follows. Score is important, but during a training session we mostly neglect it.

- During technique training attention is paid to stance and movement; score is not important (there can even be a blank butt)
- During a tournament score is important: the archer with the highest score wins. We see that elite archers pay a lot of attention to pre-shot routines and stance. The shot is executed as if it is of no consequence
- In recreational situations, such as playing a game at the end of a training session or in traditional archery, scoring is very important. Archers tend to 'neglect' the stance, but they try to perform the movement as well as possible.

### ***Shooting in bad weather conditions***

A good coach assists his athletes in learning to perform in different circumstances.

In many parts of the world archery training sessions often take place indoor, where circumstances do not change. If we were training only indoors, the archer will be facing problems when competing outdoor. The tournament fields always differ from the training indoor facility. Shooting outdoor implies a lot of disturbances. There may be wind! There may be some trees behind the butt

that in general are not straight or vertical. The grass can be cut skew to the target, and so on.

We can train to anticipate these situations by introducing an element of 'game' in our training sessions. This means that we try to deal with all kinds of 'changing circumstances'. For instance you can change the route the archer has to go from the equipment area to the shooting line by introducing some obstacles like a chair etc. In practising indoors we could change the lighting.

By introducing such 'games' we can increase attention and create a situation in which certain parts of the shooting technique are practised unperceived and without effort. Use different target faces, be an inventive coach! Training in a more 'slovenly' way gives your archers the mental room to perform better on the tournaments.

Fun is important. On the shooting line archers are very serious and try to perform their best, i.e. in the state of concentration. However, between the shooting sessions it is time to relax. The archer empties their mind from the competition by a (sometimes more than) relaxed behaviour. It is a matter of personal character, some people are introvert; others are extrovert. For the team in the ideal situation there is a mix of characters each with their own personality.

## **Literature**

Richard H. Cox, *Sport Psychology, Concepts & Applications*, (1997) ISBN 0-697-29507-9.

Aidan P. Moran, *Psychology of Concentration in Sport Performers*, (1996) ISBN 0-86377-443-9.

Don Davies, *Psychological Factors in Competitive Sport*, The Falmer Press, (1989) ISBN 1-85000-606-7.

Jean M. Williams (editor), *Applied Sport Psychology*, Mayfield Publishing Company, (1998) ISBN 1-55934-950-6.

Rico Schuijers, *Over scherp zijn gesproken*, Bohn Stafleu Van Loghum, (1997) ISBN 90 313 2447 7 (In Dutch).

Reinier Groenendijk, The Netherlands (Private communications)

F.C. Bakker, R. Groenendijk, J. Huijbers, *Presteren onder druk*, Arnhem: NOC\*NSF (1995) (In Dutch).

Paco Verkoelen, *Aspects of Coaching*, In: Technical Bulletin 10 of the Archery Coaches Federation of the Netherlands (2004) (In Dutch)



FITA  
Coach's  
Manual

**RECURVE BOW  
EQUIPMENT TUNING**  
Module

Intermediate  
Level





## Module

### RECURVE BOW EQUIPMENT TUNING

#### **Introduction, to tuning competitive recurve bows**

There is no doubt that the bow you choose is an important consideration, but even more important than the bow are the arrows you choose. In the early days of competitive archery, it was not uncommon for an archer to pay a weeks salary for a dozen top quality footed cedar arrows. Remember, it is not the bow scoring the points in the target; it is your arrow shafts. Successful bow tuning and accurate shooting can only be achieved by using arrow shafts that are properly spined to your bow and ones that are consistent in their spine, weight and straightness. Follow the many available spine charts or computer programs on the market to select the arrow size recommended for your draw length and bow poundage. Remember to read all of the information provided on the proper use for the chart too. The true verification that you have selected the correct spine will be determined during the tuning process. Problems caused by improperly spined arrow shafts will become evident during tuning. Before tuning, be sure that all arrows are straight, properly fletched, and have perfectly aligned nocks.

#### ***Shooting Technique***

Your shooting technique can have a large influence over the dynamic spine value of your arrow. Two archers shooting the exact same bow, same poundage and the same arrow length may not necessarily shoot the same arrow size. Usually, the archer who has better “line”, (see shooting form chapter for details on body alignment) will shoot a lighter (weaker) spined arrow than an archer who has poor skeletal alignment. This is because the archer with good alignment creates less side movement of the string on release resulting in less column loading of the arrow shaft.

#### ***Install All Accessories***

Before starting the bow tuning process, be sure to install every piece of equipment on your bow that you intend to use during shooting. This includes the correct bow-string and all attachments to the bow string, bow sight, stabilizers, arrow rest, cushion plunger, counter weights etc. Choose all personal items as well, like your tab, chest protector and any thing else you use when shooting. For example, simply changing a stabilizer can have an enormous effect on the tune of your bow. Any adjustments made to the bow or changes in bow components can and usually will affect the tune.

Once the equipment is fully assembled, the next phase in the process of achieving well tuned equipment is good preliminary setup. If the initial setup is done properly, the tuning process can be accomplished with little effort. By following the bow setup guidelines in the initial preparation of your equipment, you can eliminate most or all of the possible tuning problems that can make the process time consuming and unsuccessful.

Adjustments made to the bow, changes in bow components, or alterations in shooting form can affect the tune or your equipment. Remember, you and your equipment share a unique relationship and are totally integrated. Any change to either will produce varying results. During the tuning process, it is vitally important that you change only one variable at a time. Otherwise, it is very difficult to determine what adjustment caused any grouping changes. If, after trying all of the tuning adjustments outlined in this chapter, your arrows still do not fly true, it may be necessary to change your arrow size to a stiffer or weaker shaft and retune.

Arrows in flight spin, vibrate and oscillate in the horizontal plane, and can oscillate in the vertical plane with a misplaced nocking point. Proper bow-set up and tuning will help minimize the forces on the arrow and help the archer to achieve optimum performance. Unfortunately, there are many theories on arrow flight and vigorous mathematical treatment of these is a bit hard for most non-engineers to understand. The bottom line though, is that all archers can recognize the arrow flight problems and make appropriate corrections. Figures showing the rotation of arrows in the horizontal and vertical panes are shown below.



Figure 1.

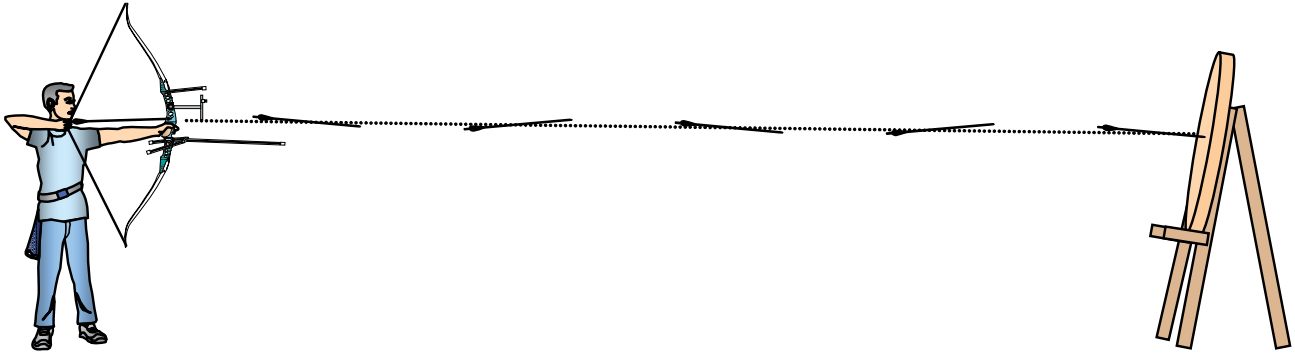

Figure 2.

In this section on recurve bow tuning it will be necessary to discuss a number of different types of risers since the available adjustment features differ in each case.

The types of risers are:

- Simple wooden self or take down bows.
- Metal risers with cushion plungers but no weight adjustment capability.
- Metal risers with cushion plungers & weight adjustment but no limb pocket adjustment capability.
- Olympic Recurve risers (weight adjustable, cushion plunger and limb alignment capability).

**Forces acting on the arrow**

For the purpose of simplicity, all discussions from this point on will be made in reference to a right handed archer shooting a right handed bow. If the archer is shooting a left handed bow the same comments apply but in reverse.

As the archer releases the arrow, the string moves horizontally to the left (facing the target) moving the nock to the left. As the string starts to move forward moving the nock end of the arrow, the point end resists this move and this results in the arrow bending toward the bow. When the arrow completes this initial bend, the string and nock move back toward centre and then to the right of centre. At this moment the front section of the arrow pushes against the sight window face or a cushion plunger if fitted. All of this action occurs in a fraction of a second in the first several inches of forward travel of the arrow. In the next horizontal bending sequence as the arrow leaves the bow face and arrow rest the arrow is in a nearly free

mode, only being held by the bowstring during this second half cycle. At the end of this complete cycle (bending in toward then bending away from the bow), the arrow nock disengages from the bowstring sending the arrow on its way to the target. These actions of the arrow are termed “Archer’s Paradox” and are the cause of arrow vibration and arrow horizontal oscillation.

The drawing shows the position of the fingers at full draw and at the time of the release, the path of the string and the initial bending of the arrow as the string propels it toward the target.

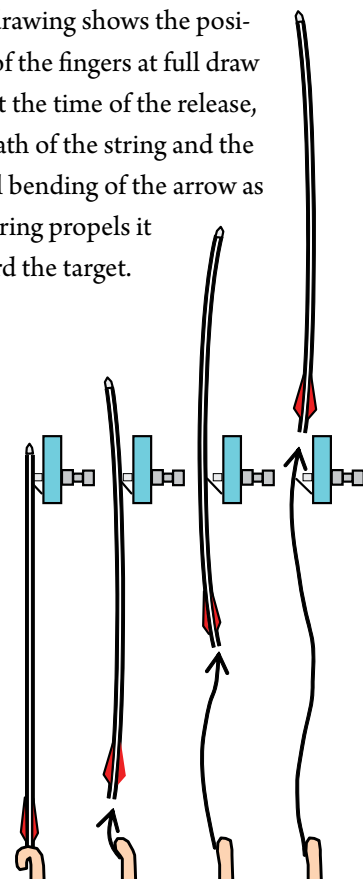

Figure 3.

### **Front of Centre Balance (FOC)**

Arrows fly more accurately and with more stability if they are front heavy. This is particularly true of shooting in the wind. The term used to describe the location of the arrow's balance point is FOC. It is defined as how far the balance point is forward of the arrow's mid point and is expressed as a percentage of total arrow length.

$$\text{FOC} = \frac{L/2 - B}{L} \times 100$$

Where: L is arrow length

B is length from balance point to front of arrow

For outdoor shooting, many archers assemble their arrows with quite a high Front of Centre balance point, though this depends on the type of arrows being assembled, the length of arrow and the poundage/speed of the bow. Consideration must be given to acquiring a good sight mark at the longest distance being shot. For indoor shooting a high Front of Centre balance point may be used but be aware that going too high may be detrimental to the performance required.

### **Tuning and Bow Set-up**

Tuning and bow set-up are the processes by which the archer can adjust the bow and arrow so that the flight problems caused by the Archer's Paradox can be minimized and good arrow grouping can be achieved. The tuning process is a whole system process wherein the bow, all of its attachments, the arrow and the archer can be brought into harmony. Any change, simple as it may seem, can affect bow tune. Something as simple as a new set of finger tabs can have a dramatic affect on a finely tuned bow. The tuning process is a discipline wherein the shooting characteristics of the arrow are modified to optimize performance. Bow set-up is a series of equipment based tasks whereas tuning is required to accommodate the shot variations caused by the archer. Properly made, matched arrows will group tightly when shot out of a shooting machine however an archer shooting the same equipment will experience shot variation.

### **Bow Set-up**

#### **Install All Accessories**

Before starting the bow tuning process, be sure to install every piece of equipment on your bow that you intend to use during shooting. This includes the correct bowstring and all attachments to the bow string, bow sight,

stabilizers, arrow rest, cushion plunger, counter weights etc. Choose all personal items as well as, your tab, chest protector and anything else you use when shooting. For example, simply changing a stabilizer can have an enormous effect on the tune of your bow.

Once the equipment is fully assembled, the next phase in the process of achieving well tuned equipment is a good preliminary setup. If the initial/preliminary setup is done properly, the tuning process can be accomplished with little effort. By following these bow setup guidelines in the initial preparation of your equipment, you can eliminate many of the possible tuning problems that can make the process time consuming and unsuccessful. Adjustments made to the bow, changes in bow components, or alterations in shooting form can affect the tune of your equipment. Remember, you and your equipment share a unique relationship and are totally integrated. Any change to either will produce varying results. During the tuning process, it is vitally important that you change only one variable at a time. Otherwise, it is very difficult to determine what adjustment caused any grouping change.

### **Nock-to-Bowstring Fit**

The force necessary to separate the nock from the bowstring serving is very critical, especially on light draw weight bows (35 lbs. and under). Nock tension should be tight enough so the arrow can easily support its own weight when the arrow is hung from the bowstring in a horizontal position but weak enough so that the arrow will fall if the string is tapped sharply with your finger (see figure 4 below). In order to get the proper nock fit you can use either a large or small groove nock or adjust the serving diameter by choosing different serving thread diameters. If the string tension is too loose, there is a danger of the nock slipping off the string at full draw causing a dry fire. This could not only damage the bow, but can also cause a serious bruise to the archers bow arm.

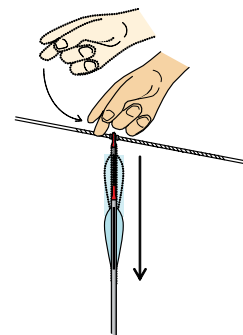

Figure 4.

**Install the Arrow Rest**

A wide variety of arrow rests is available to the archer. They all have one thing in common – they must be fitted so that the angle of the arm assists the arrow to stay on the rest and does not allow the arrow to slide off the rest before the shot is made (figure 5). Rests range from the simple stick on plastic variety to adjustable metal arms which move away from the arrow as it is shot. The high speed films described earlier show that the main function of the rest is to support the arrow during draw and during the initial movement of the arrow forward. As archer’s paradox takes place the arrow lifts off the rest. The rest needs to be adjusted so that the centre of the arrow is contacting the centre of the cushion plunger (Figure 5), and the support arm must be adjusted so that it is not visible past the outside of the arrow shaft when observed from an overhead view (figure 6).

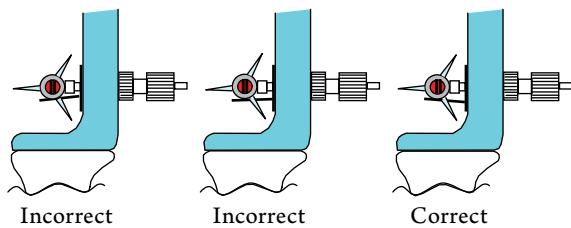

Figure 5

Angle of arrow rest arm & Plunger alignment with the arrow.

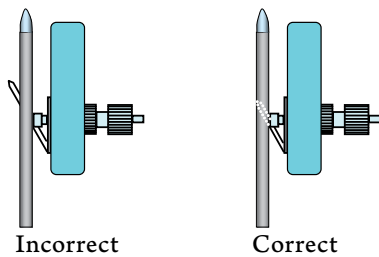

Figure 6  
Arrow Rest Arm.

**Install the Nocking Point**

This is a common step with all recurve bows. Install a moveable nocking point on the bowstring. Clamp-on types are satisfactory and easy to install but affect arrow flight. We suggest that you use a tie on nocking point.

**Initial Nocking Point Position.**

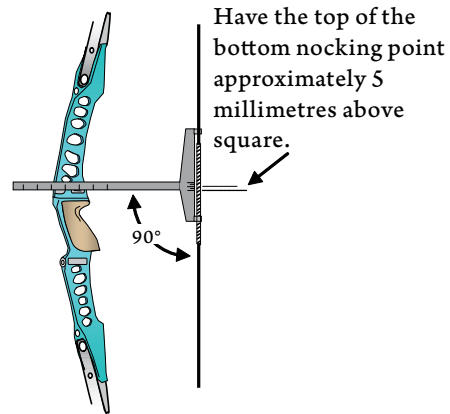

Figure 7.

Initially, position the nocking point on the bowstring about 5mm (1/4 inch) above square (Figure 7).

The nock of the arrow will be placed above this nocking point. After this nocking point is in place tie a 2nd nocking above the first one with sufficient room between the two points so that a nock will easily fit between. This will prevent an arrow from sliding down the string during shooting.

**Tying on a Nocking Point**

The tied on nocking point is made with a short piece, 30-50cm (12-20”) of the same serving material used to serve the string. Begin by tying an overhand knot around the bowstring serving. Next take the free ends, turn them under the bowstring and tighten the knot. Alternate knots above and below the string until you have tied 8-10 knots. End the nocking point by tying the final knot in a square knot. Cut off the loose ends to about 5mm (1/4”) length and heat them with a match or lighter. They will burn back to the main knot and fuse the fibres of the string you used for the nocking point. This nocking point can be moved up or down the serving by twisting it since it acts like a nut and the served string as the screw. This is the reason you should use the same material as you used for the serving since you get a perfect thread match.



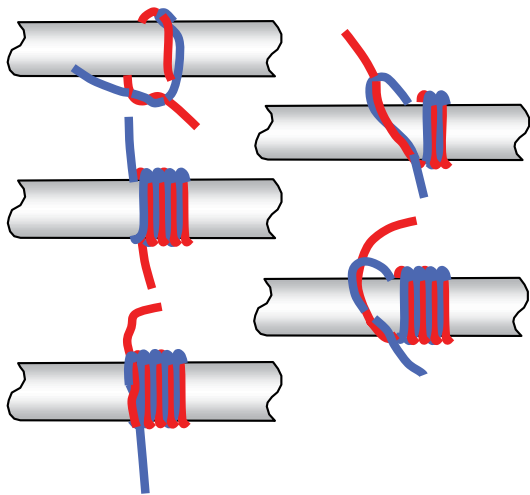
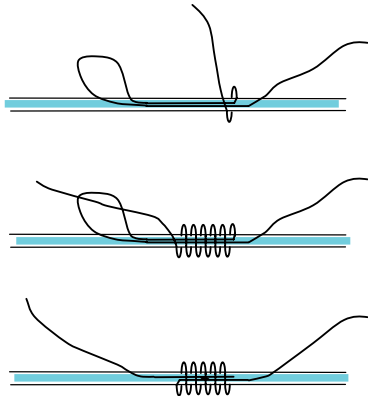

Figure 8.

**Tying on a simple Nocking Point**

Or you can tie a temporary and more simple one, as shown in Figure 9 below.

Serving material or dental floss can be used for making a nocking point. The drawing below shows a way to eliminate knots or loose ends



When the nock is completed cut the ends off and add a little glue

Figure 9.

**Finding the Limb Centres**

In order to have a reference point from which to adjust the arrow's left/right position on the bow, it is necessary to find and mark the exact centre of the limbs on your recurve bow. During the whole set-up process the bow should be mounted on a bow vice so that the limbs do not touch anything since this could distort the fragile limbs. An elaborate vice is commercially available but a simple tool can be made of wood to accomplish this (see Figure 10).

Figure 10

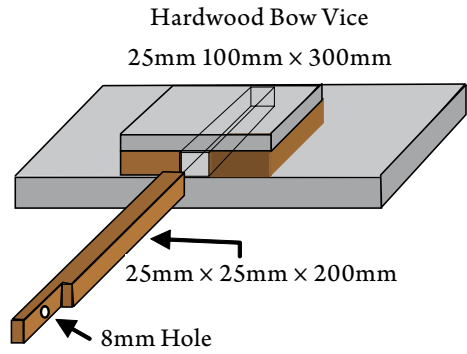

The wooden vice can be set to hold the bow either vertically for limb/arrow alignment or horizontally for serving the string (see Figure 11).

Figure 11.

*Bow Orientation in Vice*





To find the limb centre for a recurve bows, place a piece of masking tape across the inside of each limb near the limb pockets). Measure the width of each limb and make a small vertical mark on the tape in the exact centre of each limb about 15cm (6 in.) from the limb pockets of the riser. Be very accurate when doing this and measure several times to know you have located the exact centre of each limb. This mark will be used for arrow centering. It may be easier to see if the string is centralised if two lines are marked on the limb, instead of one, which are 3 millimetres apart. With one line this line would be hidden behind the string when alignment is being checked. More conveniently use commercially available “Limb Line Gauges” available from most good archery shops.

After you mark the limb centres on the tape or install the Limb Line Gauges, stand back and attempt to sight align the string with the 2 marks. If you cannot do this you will need to either average the alignment or if your bow has the capability of adjusting limb alignment, do so. This is most easily accomplished by placing one marked tape where the limb comes out of the riser and one tape at 15cm (6in.) from the bow tip on both limbs (or use specific gauges). You can then check the alignment of the 4 marks to assess if the limbs are properly aligned (Figure 12). Stand back and sight through the string to see if it covers all 4 marks. If not, make limb alignment adjustments as required.

Some bows may have a slightly bent riser or crooked limbs. In this case, since the string will not perfectly bisect the centre of both limbs at the same time, you will need to compensate or average the string position for the slight imbalance. This does not mean the bow will not shoot accurately, it simply means you need to compensate for this situation.

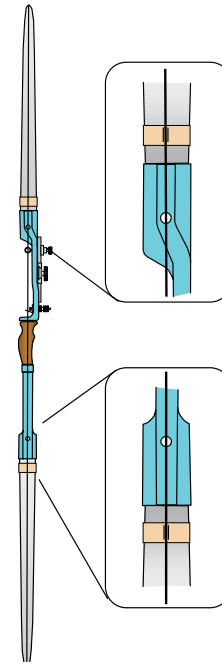

Figure 12.

### “Centering” the Arrow: Adjusting the Arrow’s Left/Right Position

The objective of arrow centering is to have the arrow leave the bow in the same vertical plane as the average string force moves. To accomplish this, the archer should stand behind the bow which is held in a vertical position and sight forward through the string which is aligned with the bow centreline. See Figure 13 for proper arrow centering. The arrow should be moved in or out from the bow so that the point appears just to the left of the string. For bows equipped with a cushion plunger this can be accomplished by turning it in or out. Bows without a cushion plunger can be built out from the bow face if the arrow must be moved left however if the point is already outside of the string it is impossible to move the point further right because of the riser.

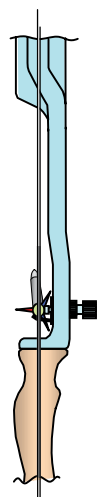

Figure 13.

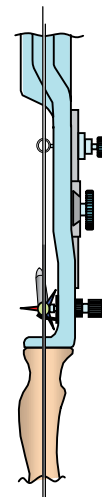

Figure 14.

**Align the Bow Sight Pin or Aperture:**

Set the sight pin or aperture on your bow sight directly over the string when it is aligned down the centre of the bow, see figure 14. The one object of the tuning process which follows is to select the correct arrow and bow adjustment so that the arrow is aimed and moves forward in the force plane of the moving bowstring as the arrow is shot. You will notice a number of archers whose sight is either outside or inside the string. This is because they have tuned their bows to an improper initial arrow alignment or are using arrows either too stiff or too weak for their set-up.

**Notes on Clickers**

There are several things to be aware of when using a clicker. Be sure that the arrow is well supported on the rest and not held in place only by the tension of the clicker. Draw the bow a few times without the clicker to make sure the arrow can be drawn and let down without the arrow falling off the arrow rest. The clicker tension and angle are important too. The clicker should not be so stiff that it actually moves the cushion plunger in or places a downward pressure on the arrow. To test this, stand in front of a target (just in case you have an unexpected loose of the string) and draw the arrow through the clicker as if you were going to shoot, but do not shoot the arrow. Rather, watch only the arrow on the rest to detect any movement of the arrow at the moment the arrow is pulled through the clicker and the clicker makes contact with the riser. If there is any movement of the arrow, either a bounce on the arrow rest or the arrow moves out due to cushion plunger activation, you need to correct this. There must not be any observable movement of the arrow when the clicker is activated.

**Set the Cushion Plunger Pressure**

If the bow is equipped with a cushion plunger, set the plunger tension to 40% of the tension of the lightest spring. The setting will change later on in the tuning process. If you don't use a cushion plunger, your tuning adjustments are going to be far more limited in the tuning process.

**Setting Initial Brace Height**

Start with the brace height at the lower end of the manufacturer's recommendation range or use the following chart.

64" 8 1/8"–8 3/8" (21.0 cm–21.6 cm)

66" 8 1/4"–8 1/2" (21.3 cm–21.9 cm)

68" 8 3/8"–8 5/8" (21.6 cm–22.2 cm)

70" 8 1/2"–8 3/4" (21.7 cm–22.5 cm)

The manufacturer recommended brace height setting is only a guideline. Changing the brace height to a slightly higher or lower position can affect arrow flight and grouping. The proper setting for best arrow grouping performance will be determined later in the tuning section.

**Tiller**

Tiller is the term used to describe the relative bending of both bow limbs. It is assessed by measuring the perpendicular distance between the bow string and limb at the end of the limb pockets. By convention, the readings are made in reference to the upper limb reading. Hence, a positive tiller is one where the distance from the string to the upper limb at the limb pocket (a) is greater than the distance for the lower limb (b), see figure 15.

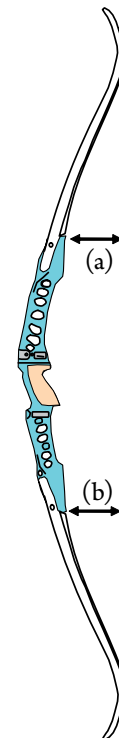

Figure 15.

A negative tiller is where the lower reading is greater. For many years it was accepted that a positive tiller was required since the archer was grasping the string above the bow centre and held the string with one finger above and two below the arrow nock and was a result of the pressure point of the hand on the riser. Recently most archers adjust the tiller to zero or leave it where the manufacturer

made the limbs. The latter is probably a bad idea since some limb pairs as purchased can have an initial tiller as high as 20mm (3/4 inch).

Some archers and coaches feel that it is necessary to adjust the tiller to keep the sight steady on the target. To do this, make very small adjustments to tiller (less than 2mm at a time) and see how your sight pattern is affected. Another indication that the tiller is correct is the bow hand will feel like one concentrated point rather than a slight rocking feeling in the hand. On the other hand, many archers and coaches set the tiller at zero and leave it there.

**One note of caution.** Changing tiller moves the location of the nocking point and its position must be readjusted after each change in tiller. Increasing tiller moves the nocking point down and reducing tiller moves the nocking point up in relation to the arrow rest. The nocking point must be relocated after each tiller change. Do not use tiller adjustments as a means of moving the nocking point since changes in tiller affect how the bow performs.

### ***Setting the Final Brace Height***

All bows are different, even bows of the same make and model can have small variations in limb length. Therefore, it is important to locate a brace height that fits your particular bow and shooting style. Shoot a few arrows at the suggested beginning brace height, then unstring the bow, add 3-4 twists to the bowstring and shoot again. Continue this process until the bow feels smoothest and quietest when shooting.

If the bowstring is too short to allow a brace height at the lower setting, use a slightly longer string. If the string is too long to allow a higher brace height (and starts to knot-up from too many twists), try a slightly shorter bowstring. There are many custom bowstring makers who produce strings to your exact specifications including length, type of material, number of strands in the string and type and colour of serving. If there are a lot of twists in the string, it will take fewer twists to increase brace height than if there are few twists in the string. Also, it is not recommended to have too many twists in the string or it will act more like a spring than a string. But, there should be enough twists to make it look like a nice round cable.

## **Tuning**

### ***General***

After the bow is set-up as outlined above, the archer may begin the tuning process.

As described earlier, the finger release causes the arrow to vibrate and to oscillate in the horizontal plane. Arrow flight appears to follow a snake like movement pattern. These movements of the arrow are caused by archer's paradox where the string moves around the fingers on release. The goal of tuning is to select and adjust an arrow's flight characteristics to minimize these effects and to get the arrow to leave the bow with zero deg. angular rotation. It will still be vibrating but these vibrations are dampened out in the first 20-25m of flight by drag forces on the arrow shaft. Tuning will also minimize the archer's shooting form variability and help him get smaller groups.

Your shooting technique can have a large influence over the dynamic properties of your arrow. Two archers shooting the exact same bow, same poundage and the same arrow length may not necessarily require the same arrow size. Usually, the archer who has better "line", (see shooting form chapter for details on body alignment) will shoot a lighter (weaker) spined arrow than an archer who has poor skeletal alignment. This is because the archer with good alignment creates less side movement of the string on release resulting in less initial bending of the arrow shaft.

As will be shown shortly, there are a number of interacting tuning variables which can be employed to best tune your system. There is not one unique set-up of these variables to achieve the desired minimum group size you are seeking. In fact, it is normal to be able to achieve a good bow tune with more than one stiffness grade of arrow. With this in mind, many people prefer to tune their bow with a stiffer arrow because it is believed to be more forgiving. Forgiving in this sense is that the arrow will readily accommodate variations in the archers shooting technique.

Tuning is best carried out as a statistical process. Each arrow should be numbered to see if there is any flight bias, good or bad, associated with that arrow. The archer should shoot more than the minimum of shots to characterize their arrow flight. For example, if the method calls for shooting 1 or 3 arrows from a given distance it is suggested that the archer shoots at least 6 shots. The archer can then eliminate or discount any obvious poor shots from consideration.



### **Tuning Methods**

There are a number of tuning methods used today but most are either lengthy or inaccurate. Many depend on the use of bare shafts as a primary reference for fletched arrow flight. Bare shafts do not have good flight characteristics unless the bow is fairly well tuned. Some of the tuning methods used and comments on them are:

**Paper Tuning:** Primarily a compound bow with release aid tuning method. Because of archer's paradox and the resultant arrow flight this method has little validity for people using their fingers to release the arrow.

**Walk Back Tuning:** Involves shooting arrows at distances of 20-40 metres without moving the sight and aiming at the same point and then analyzing the hit pattern. This method is not sufficiently sensitive in tuning carbon/aluminium shafts but is said to work satisfactorily with aluminium arrows.

**Short Distance Tuning:** This method involves shooting fletched arrows at a vertical and a horizontal line. It is used mainly to verify nocking point and cushion plunger in/out setting.

**Bare Shaft Planing Test:** This method compares the grouping pattern of bare and fletched shafts. It produces good results but shooting bare shafts before a good tune is achieved may be frustrating for the archer.

**Fletched Arrow Group Tuning:** This method has been used for many years and does not have a name. It is probably the simplest method that yields the best results of other tuning methods and is highly recommended. It can also involve shooting bare shafts but not before a basic tune is established.

### **Tuning Tools**

In all of the tuning methods a number of variables can be used to adjust the shooting characteristics of an arrow. All of the following deal with the arrow's *dynamic spine* which is the amount of initial bend the arrow undergoes as the string is released. It is how weak or stiff the arrow is as it is shot. Most frequently this characteristic is referred to as the arrow's *spine*. Unfortunately, arrow manufacturers also use the same term, *spine*, to describe the *stiffness* of their shafts. These two "*spines*" are really "*static spine*" or the stiffness of the arrow at rest as measured by

a spine or deflection tester and "*dynamic spine*" which is the bending characteristics of an arrow as it is shot from the bow.

### **Factors Affecting Dynamic Spine**

Dynamic spine is affected by a number of factors, most of which can be adjusted to improve arrow flight.

#### *Adjustments to increase dynamic spine, "making the arrow shoot stiffer"*

- decrease point weight
- add weight to the nock end of the arrow
- shorten the shaft
- decrease bow weight
- decrease brace height. Be careful here as this gives a longer power stroke thus makes the arrow seem weaker.
- increase string weight
- change arrows to a stiffer shaft size, i.e., lower static spine value.

#### *Adjustments to decrease dynamic spine, "making the arrow shoot weaker or bend more"*

- increase point weight
- lengthen the shaft
- increase bow weight
- increase brace height be careful here as this gives a shorter power stroke thus makes the arrow seem stiffer.
- decrease string weight
- change arrows to a weaker shaft size, i.e., increase static spine value.

There are some limitations in applying these changes. The point weights are determined by what the archer can purchase. If the archer is using aluminium arrows he can add lead to the inside of the point to increase its weight. It is obvious that you can cut off some of the arrows shaft to shorten it but you can't lengthen the shaft without purchasing new shafts. If you increase bow weight you may get to the point the bow is too heavy for you to control.

### **Bowstring**

Serving weight (centre serving) can affect dynamic spine. For example, monofilament centre serving will cause the arrow to react stiffer than lighter weight nylon centre serving. Simply changing from a metal nocking point to a "tie-on" nocking point can have a noticeable affect on

arrow spine due to the weight difference between the two styles of nocking points.

### Objective of Bow Tuning

The goal of tuning your bow is to set it up so that you can get the smallest group possible within your shooting ability.

Many people look for the best arrow flight or being able to shoot bare shafts into the fletched shaft group. There are many incidences where elite archers get excellent groups without perfect arrow flight. It is also normal for the bare shafts to hit just outside the fletched shaft group. Since bare shafts are lighter than fletched shafts and have a no rear weight (the fletchings), depending on the distance being shot, it might be expected that the unfletched shafts would hit higher and to the left (right hand archer) of the fletched shafts.

### Starting the Tuning Process

Follow the many available manufacturers' spine charts to select the arrow size recommended for your draw length and bow poundage to use as a starting point in developing the proper arrows for you. Read all of the information provided on the proper use of the chart. Many people have found that the arrow sizes recommended by the manufacturer is at least one stiffness grade too stiff so it may be wise to try the arrows or pick one grade less stiff shaft as a starting point.

Verification that you have selected the correct spine will be determined during the tuning process. Problems caused by improperly spined arrow shafts will become evident during this process. Before tuning, be sure that all arrows are straight, properly fletched, and have perfectly aligned nocks. Now that you have completed the preliminary adjustments and properly set up your bow, you are ready to start the tuning process.

### Establishing a Basic Tune

It is suggested that you begin with the Bare Shaft test. Shoot bare shafts at a target at 5m. In this way you will see how the shaft leaves the bow and you can adjust your nocking point and cushion plunger as needed. Adjust the nocking point as shown in Figure 16.

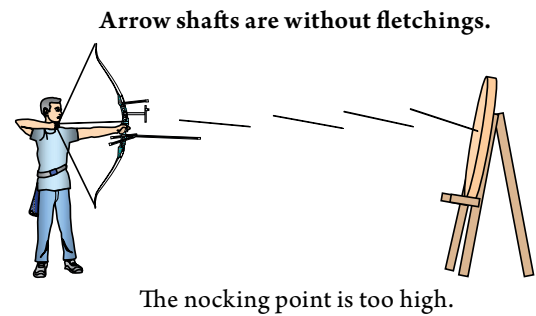

Figure 16.

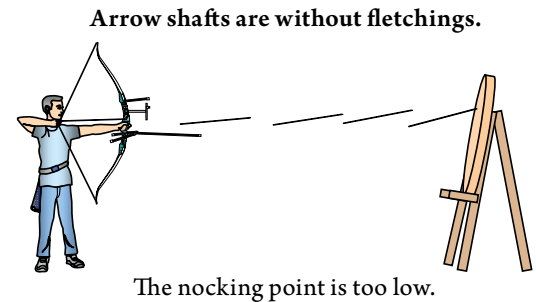

Figure 17.

### Fishtailing: (caused buy mismatched arrow spine).

If the arrow leaves the bow with the nock end leaning to one side or the other, fishtailing occurs. The nock end of the arrow will appear to move from side to side as the arrow follows its flight path. See Figure 18.



Figure 18.

Using the **Bare Shaft Planing** Test to correct fishtailing, continue to shoot three fletched shafts and two or three identically aimed unfletched shafts. Again, make sure the bare shafts will hit the target before moving back further than 20 yards. If the unfletched shafts impact left of the fletched shafts, the arrow is too stiff (for a right-handed archer, opposite (weak) for a left hand archer). If the bare shafts impact more than 2" to 3" inches (5 to 8 cm) at 20 yards, this will mean that the bare shafts will be well away from the fletched shafts at a longer distance like 30 meters and may not even hit the target. In this case, is not likely that any decrease the spring tension on the cushion plunger will be much help. It is better to use a more effective **gross adjustment**, or a combination of adjustments before working with the cushion plunger (making sure that the cushion plunger is still set at a medium spring ten-

sion). If your bow weight is adjustable, increase the bow weight by approximately 1 pound. An adjustment more than one pound is not recommended unless the archer is in very good physical condition and even then an archer should never increase more than 2 pounds at a time as it could have detrimental affects on shooting technique and possibly induce an injury. Other gross adjustments that will improve the spine compatibility of an arrow that is too stiff are an increase in arrow point weight and a reduction in the number of strands in the string (reducing the physical weight of the bowstring). In the same relation, a decrease in the weight of the centre serving material or a decrease in the length of the centre serving will have a similar effect as well as a reduction in the weight of the nocking point (example: changing from a metal nocking point to a tie-on type).

If the unfletched shafts impact right of the identically aimed fletched shafts (weak), (for a right-handed archer, opposite (stiff) for a left hand archer), decrease bow weight slightly (if your bow weight is adjustable) and or decrease arrow point weight. Here, the bow weight would be your best adjustment to move the bare shafts into or near the same group as the fletched shafts. Going down in bow weight is not a problem other than losing a little arrow speed. Your equipment is basically tuned when the bare shafts and fletched shafts impact at the same or very near the same location. Once you have completed the Fine Tuning process do not be surprised if the bare shaft impact changes. It is common on a well-tuned bow to have the bare shafts impact a different location than the fletched shafts. Usually, a good tune will have the bare shafts impacting close to the fletched shafts in the horizontal plane, but if the nocking point height is not correct the bare shaft impact position may be slightly higher or lower than the fletched shafts impact position.

### ***Cushion Plunger Setting***

When correcting fishtailing using the Bare Shaft Planing Test, use the cushion plunger for fine adjustments only and not for large horizontal adjustments. It is important to first have good spine compatibility for the bow before using the cushion plunger to correct gross errors in spine. In the fine tuning process, the cushion plunger's ability for improving grouping will become evident. Also, it is important to note that when adjusting the cushion plunger tension, it will almost always affect nocking point height as well as dynamic spine. Don't be surprised if the bare shaft impacts change in height as well as horizontal impact.

If during the tuning process you are unable to get the unfletched shafts to impact near the fletched shafts in the horizontal plane, it will most likely be necessary to change arrow sizes. Your arrows might be too weak (the unfletched shaft impacts to the right of the fletched shaft for right-handed archers) or too stiff (the unfletched shaft impacts to the left of the fletched shaft for right-handed archers). If, after completing this test, the bare shaft impact is more than 3 inches (8 cm) to the right (weak) or left (stiff) of the fletched shafts at 20 yards (18 m), you will most likely need to change shaft size. However, before going to this more costly investment, make sure you are not having a false tuning indicator caused by a clearance problem. Usually, incompatible arrow spine is the biggest cause of a clearance problem, but not always.

### ***Clearance***

To check for clearance, use dry powder foot spray, dry deodorant spray or similar product applied to the last quarter of the arrow shaft, fletching, arrow rest assembly and sight window near the arrow rest. Do not disturb the powder sprayed on the arrow and bow while preparing to shoot. The arrow should be shot into a firm target so that it will not penetrate to the powder area. Then check the powder on the arrow to see if there are any marks indicating an impact between the arrow and bow.

### ***Correcting Clearance Problems***

If you are not achieving good arrow clearance, and the arrow fletching and bow make contact, optimum grouping cannot be achieved. By examining the areas where the dry powder spray is scraped off, the nature of any interference can be determined, and the position of the fletching as the arrow leaves the bow can be identified. If there is a clearance problem, this can usually be seen in the arrows flight to the target. A term used to explain the visual flight disturbance is called Minnowing. Like fishtailing or Porpoising, Minnowing describes a specific arrow flight disturbance. Minnowing will appear to look much like fishtailing except that the tail of the arrow appears to move from side to side more quickly, and the amount of side swing is usually much less than in fishtailing. See Figure 19.

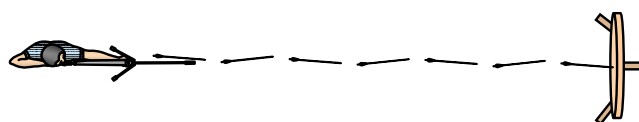

Figure 19.

Minnowing indicates inadequate clearance and is caused by the rear portion of the arrow (usually fletching) contacting the arrow rest or cushion plunger. The following procedures can help you correct clearance problems that cause minnowing:

- If the arrow fletching is hitting the arrow rest, try rotating your arrow nock  $\frac{1}{32}$  of a turn. Continue rotating the nock in  $\frac{1}{32}$ -turn increments until clearance is achieved.
- Make sure your arrow rest support arm does not protrude past the outside of the arrow shaft when the arrow is resting on the support arm and is lying against the cushion plunger or side loading device. See Figures 5 & 6.
- Choose a lower profile fletching.
- Follow the procedures for Tuning Adjustments for nock indexing and arrow rest set up.
- Make sure the bow hand is well relaxed to eliminate bow hand torque.
- Move the cushion plunger slightly out from the bow to help increase clearance if the other tuning modifications have no effect.

### ***Trouble-Shooting Arrow Groups***

You may have heard someone say, “If your arrows group well at 20 yards, they will group at any distance,” or, “If your arrows group at long distances, they will group at short distances.” In some cases, neither statement is true. There may be a minute disturbance in the equipment that affects the equipment’s potential for superior accuracy causing poor arrow grouping. What follows here is information that will help you perform the fine tuning adjustments necessary to eliminate most or all of the minute tuning problems.

Many archers have experienced one or all of the following arrow grouping/arrow flight combinations: poor arrow flight and good grouping. This is commonly the result of a stiff arrow. The arrow yaws slightly as it leaves the bow, but usually recovers quickly and often produces very acceptable grouping.

Good arrow flight and poor grouping. Although this seems contradictory, the phenomenon is somewhat common and relates to the tuning method used, or a lack of fine tuning. Having perfect arrow flight, or having the bare shafts impact exactly with the fletched shafts using the Bare Shaft Planing Test, does not always mean your arrows will group well; it only means the arrows fly well.

The section on Fine Tuning will assist you in obtaining optimal grouping from your equipment as well as good arrow flight. It is best to work toward good arrow flight and good grouping as this will produce the most consistent results in any weather and especially windy conditions.

Arrow grouping patterns often reveal probable arrow flight problems. Two of the most common grouping indicators for determining arrow flight problems are described below.

### ***Excessive Drag***

If the arrow has too much drag, that is the fletchings are too large or the fletch are off-set too much, it can cause excessive drag and grouping will often suffer at long distance. For example, if shooting FITA distances of 90, 70, 50 and 30 meters for men and 70, 60, 50 and 30 meters for women, you may experience good grouping on all distances except for the longest distance. If this is the case, the arrow most likely has too much drag. Excessive drag will cause the arrow to become unstable due to the rapid decay of its forward velocity. When forward velocity drops too quickly, instability occurs. This unstable flight causes poor grouping at long distances and extreme vulnerability to wind drift. On lightweight arrows, it is very important to reduce drag to a minimum to maintain maximum downrange velocity. This can be done by reducing the size (height and/or length) of the fletching or by reducing the angle of the fletching, or both.

### ***Insufficient Clearance***

A clearance problem will usually have the opposite effect of excessive drag. Most often arrow grouping is acceptable at longer distances, however, the shorter distance groups are not reduced in size proportionately to those at the longer distances. This situation commonly results in short distance scores that are significantly less than what the longer distance scores would indicate. If this is a familiar scenario, look for a clearance problem or micro disturbance within the bow and arrow system. To correct, see the section on Clearance.

### ***Adjusting the Bow and Arrow System***

If you are having problems tuning your bow, you will need to make some modifications to your equipment to achieve a better tune. Here are some suggestions:



### **Bow Weight Adjustment**

Virtually all target quality recurve bows have an adjustable draw weight system. Bow weight adjustment should be the first tuning consideration if your arrow reaction is significantly stiff or weak. It is important not to increase bow weight more than one to two pounds as it could have detrimental effect on shooting technique. Here is a good guideline to follow to know if you can physically handle any increase in bow weight. Simply draw and hold your bow at full draw for 60 seconds. If it you can hold the weight for an entire minute, you can handle the one to two pound increase. If the arrow reaction is too stiff when applying the bare shaft tuning test, increase the draw weight. If your arrow reaction is too weak, decrease the draw weight.

### **Bowstring**

Bowstring “weight” can have a significant effect on arrow spine. Increasing or decreasing the number of strands in the bowstring can influence the arrow’s dynamic spine enough to require a shaft size change of up to one full size weaker or stiffer. If your arrow reaction is too stiff, decrease the number of strands in your bowstring. If your arrow reaction is too weak, increase the number of strands. Serving weight (centre serving) can also produce the same effect. For example, monofilament centre serving will cause the arrow to react stiffer than lighter weight nylon centre serving. Simply changing from a metal nocking point to a “tie-on” nocking point can have a noticeable effect on arrow spine as well due to the weight difference between the two styles of nocking points.

### **Point and Insert Weight**

The arrows dynamic spine can be tuned by using various point and/or insert/outsert weight combinations. If your arrow is too weak, go to a lighter insert or point. If your arrow is too stiff, try a heavier insert or point. Continue to change insert and/or point weights within an acceptable balance point range (10–18% F.O.C.).

### **Documenting Equipment**

Once you have completed the Bare shaft Planing Test and before starting the fine tuning process, it is important to write down the exact measurements of your bow. Having all of the equipment information documented will allow you to return to the initial settings if something strange happens during the fine tuning process. When your bow and arrow are fully compatible and optimum arrow flight

and grouping have been achieved, then you will want to re-document the equipment for future reference.

Following is most of the information that should be included in the documentation.

- a. Nocking point height.
- b. Brace height.
- c. Tiller.
- d. Number of strands in the bowstring and type of material.
- e. Type of centre serving and end serving.
- f. Bow string weight (use a grain scale).
- g. Weight of bow at full draw weight.
- h. Type of stabilizers used, length, amount of weight on each rod etc.

In other words, everything you can think of to document your equipment.

Next, number all of your arrows. This enables you to plot groups and to plot each individual arrow. This process is very important in discovering which arrows group consistently and those that don’t. Another good trick is to place a small “dot” on one fletch each time that arrow hits the “10” ring (best to do this only for the longer distances). Pretty soon, it is clear what arrows you will want to use in competition ..... the ones with the most dots!

When you are ready to start the fine tuning process, use a new 40 cm target face and use it as the “plotting” target. This will allow you to record each arrow impact and the number of that arrow to determine common impact points for each arrow in the bunch.

- Prepare to shoot from a distance you are most comfortable with from 40 to 70 yards or meters, on a face size you are comfortable with, and depending on your skill level.
- Shoot an end or two to warm up before starting the plotting process.
- After warming up, shoot a group of 6 to 10 fletched arrows.
- Write down the number of each arrow and the impact point on the sample “plotting” target.
- Shoot at least two groups before making any adjustments. Remember to make only one adjustment at a time. When making a tuning adjustment, use a different coloured pen for each time an adjustment is made or use another plotting target so the results are not confused.

- Examine the groups for patterns to see if the group is more vertical than horizontal, more horizontal than vertical or if there is not discernable pattern.

### ***Reading the Plotted Arrow Groups***

Carefully examine the arrow grouping patterns you plotted. Note the different shapes of the groups and how the adjustments altered the arrow impact and size of the groups. Examine each arrow by its number. Take careful note of any arrows that did not group consistently with the other shafts. Monitor these shafts to see if they are consistently out of the group as you will probably want to mark these shafts so you will know not to use them in competition.

### ***Vertical grouping patterns***

If the groups are more vertical than horizontal, adjust the nocking point  $\frac{1}{32}$ " (.8 mm) either up or down. Shoot another two groups and plot the arrows in the same manner as described above. For future reference, be sure to write down your bow adjustment on each arrow group you plot. Measure the distance between the high and low arrow to determine an average between the groups. This will help to identify if the high and low arrow impact has improved or not in the next grouping sequence. If it has improved, make another adjustment of  $\frac{1}{32}$ " (.8 mm) in the same direction and shoot another two ends. If the high and low arrow impact is better, continue in that direction until you achieve the most consistent group elevation. Obviously if the vertical impacts are worse, go back to the original setting and make the same adjustment in the opposite direction.

### ***Horizontal grouping patterns***

While tuning, remember to continue the documenting process on each plotted arrow group for the one tuning variable that was changed. For horizontal adjustments it is best to adjust only the cushion plunger spring tension, not the in/out position of the cushion plunger. Make adjustments to the cushion plunger spring tension in  $\frac{1}{8}$  turn increments only. Shoot two groups and measure the farthest left and right arrows (eliminating arrows where known mistakes were made in the technique). Make the first spring tension adjustment either stiffer or weaker and shoot two more ends. Again, if the group becomes wider, go back to the original setting and make an adjustment of  $\frac{1}{8}$  turn in the opposite direction. Compare the groups you just shot and determine if they are getting

better or worse. If the groups improved, make another adjustment of  $\frac{1}{8}$  turn in the same direction and shoot another two ends. Continue this process until you have achieved the tightest possible grouping in the horizontal plane at that distance. If the groups do not change, continue following this procedure until the groups improve or become wider. At the point where the groups just start to get wider, go back  $\frac{1}{8}$  turn to the previous setting and make a small nocking point adjustment. Remember, adjustments to the cushion plunger will often have some effect on the nocking point and it may be necessary to make small adjustments to the nocking point during the cushion plunger adjustments. Here is where you should see some significant group changes (hopefully much better). Remember to make only one adjustment at a time. If the groups become worse, go back to the original nocking point setting and make the same adjustment in the opposite direction to compare. Continue this process until the best possible groups have been achieved with this single adjustment. Then, start making  $\frac{1}{8}$  turn spring tension adjustments to see what happens to the grouping patterns. Obviously if the groups are consistently GREAT, stop and re-document all the settings.

The fine tuning process is a dynamic relationship between the nocking point height and the cushion plunger spring tension. Any change to one affects the other and it is important to understand this relationship. When making only one adjustment at a time, you will find the ability to continually "compress" the up/down and left/right grouping patterns into the best possible grouping your skill level is capable of. After completing this procedure, you should find a combination of adjustments that will either slightly or significantly improve arrow grouping.

Once you have completed the long distance tuning, move to 20 yards (18 m) and see if the bow continues to group well here too. It should, but if not look for a clearance problem. By shooting all your competition distances at the end of the fine tuning, you will have confidence in knowing that your equipment can perform well at any distance when shooting competition.

### ***Fine tuning the brace height***

Finding the correct brace height for your bow can, in many cases, greatly improve consistency and grouping and should be considered as a fine-tuning adjustment.

The chart below shows the maximum range of brace height for most modern recurve bows. However, these are extreme at the high and low end of the range and

somewhere in between is most likely where your final brace height will end up. Changes within the brace height ranges shown can affect arrow spine as much as changing the arrow point and/or insert weight approximately 20 grains. Remember, it is best to shoot your bow at its smoothest and quietest setting. The chart below shows a range wide enough to create a “between” size arrow spine.

***Maximum Recommended Brace Height Range for Most Competition Recurve Bows (by bow length)***

**64"** - 7 3/4" to 9" (19.7 cm to 22.9 cm)

**66"** - 8" to 9 1/4" (20.3 cm to 23.5 cm)

**68"** - 8 1/4" to 9 1/2" (21.0 cm to 24.1 cm)

**70"** - 8 1/2" to 9 3/4" (21.6 cm to 24.8 cm)

Brace height is a fine tuning adjustment and should be done in small increments. When working through the fine tuning process, try making a small brace height adjustment to see how it affects grouping. If the string has very few twists, it will take more turns to achieve a specific change than if the string has numerous twists. Make adjustments in very small increments of 1/16" at a time and see how the groups are affected and note any changes in the sound and feel of the bow. If the string has many twists, it will take only one or two turns to achieve the 1/16" brace height change. If the string has very few twists, it may take 3 or more twists to achieve the same result.

***Identifying Specific Arrow Problems***

You may find an arrow that does not group well with the other arrows in the set. Examine it before you discard that arrow or retire it from competition. Sometimes a problem is easily identified and other problems are not so evident. If a shaft is cracked or dented it should be discarded. Some arrows may seem fine, but they may have problems that are not obvious and can cause the arrows to group poorly. The following list identifies common arrow problems, which may cause inconsistent or a stray impact.

***Arrow Straightness***

Arrows must be straight for tight grouping. Straightness should be within 0.004" or better for best grouping. This also depends where the bend is located. A slight bend near the nock end of the shaft may cause a greater impact variation than a larger bent that is over the full length of the shaft.

***Crooked Nocks***

There are several ways to check nock straightness, including commercially available nock gauges and special arrow spinning wheels. Make sure the nocks are absolutely straight. Crooked nocks can cause severe accuracy problems.

***Nock Indexing***

It is possible that one nock in the set may be turned more than the others. A clearance problem results if the nock is rotated too far, forcing the fletching into the arrow rest or cushion plunger when shot. Make sure all nocks are indexed the same and that the spacing between the two “clearance fletches” (the two vanes that clear past the arrow rest and cushion plunger) is the same. When fletching, it is common for some fletch to be spaced closer together than others on the shaft. Always choose the two vanes that are furthest apart to use as the clearance fletch.

***Loose or Damaged Fletching***

Fletching that is slightly damaged will not usually affect arrow grouping, but if the fletching becomes even slightly detached from the shaft, the arrow will not group with the others. The arrow may not even hit the target past 30 yards (meters). In the case of hard plastic vanes, if the rear of any vane is bent, it will also cause a change in impact.

***Loose Points/Inserts***

Many archers are not aware of this potential problem. Points must be properly installed with good hot melt adhesive or epoxy, depending on the shaft material. Carefully follow the instructions on point/insert installation from the arrow manufacturer. Some brands of hot melt are often brittle and may fracture when the arrow impacts hard target butt materials. If the cement fractures or the point is improperly installed, it can result in a separation between the point/insert and the shaft. When separation occurs and the arrow is shot, the separation of the bond between the shaft and point can cause the point to vibrate against the shaft wall affecting the arrow’s natural frequency of vibration and arrow accuracy. To test for point vibration, hold the arrow a few inches below the fletching and lightly tap the point on carpet or grass. If you hear a buzzing sound, the point/insert is probably loose. Heat and pull out the point/insert and properly reinstall. You

may also get the same buzzing sound if you tap the arrow against the string before loading.

### ***Arrow Weight***

Arrow weight is an important consideration for tournament archers and should be checked. If you have arrows that consistently impact a little high or low of your group it may be due to a slight weight variation. A matched set of arrows should have no more than a three grain spread

between the heaviest and lightest arrows in the set. Top tournament archers frequently match their arrows to one grain or less.

In conclusion, don't be afraid to make tuning adjustments as it is the best way to learn how you and your equipment interact. You will learn a lot in the process and as long as the equipment is well documented, you can always go back to the original settings.





FITA  
Coach's  
Manual

**RECURVE BOW  
SHOOTING FORM**  
Module

Intermediate  
Level



Module

**RECURVE BOW SHOOTING FORM**

**1. Stance**

Stance is one of the most basic poses of an archer. Many changes come into being in the angles of the entire body which relate to the basic form of the stance. Some small changes may need to be introduced to be in accordance with an archer's physical shape of the body and the characteristics of the pose. However, it is most important for an archer to master an accurate and basic square stance when they are in the beginning stages. Once the archer moves on to the improving stage it is better for them to choose the stance that suits their body structure and them as an individual.

**Width of stance (placement of the feet)**

To accomplish a good comfortable and stable stance there maybe some areas that need to be considered in accordance with an archer's weight, height, and the form of the stance. As for the width of stance, it is good for the archer to have the feet placed equal to, or just a little wider than the width of the shoulders.

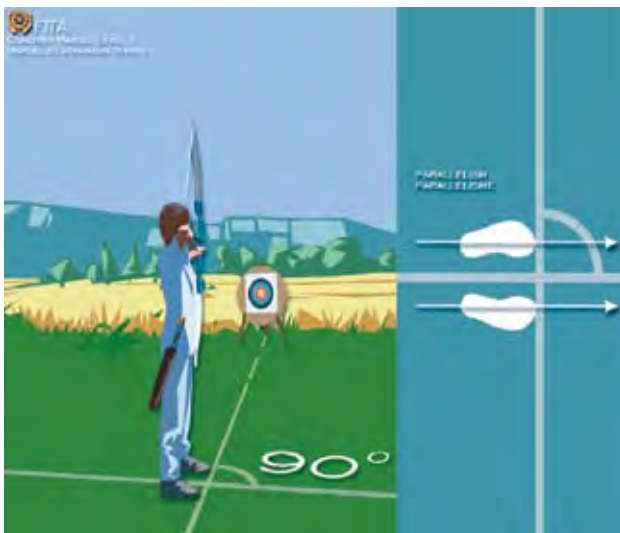

**The centre line of the body when assuming the stance**  
The centre line of a body at the time of assuming the stance is very important. This centre line of the body comes under continuous movement while the bow is being drawn. Even at the time of extending the body to complete the shot a lot of influence is exerted and the line may deviate from the vertical. The archer should be particularly careful to maintain the vertical position.

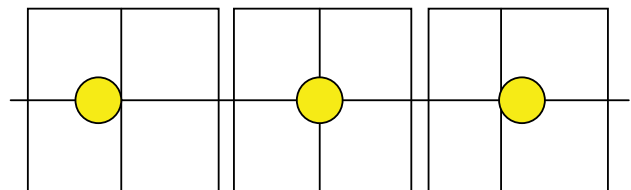

**The square stance**

A beginner should be able to easily master the square stance. They can easily maintain a fixed body angle and centre line of the body. Once the archer has mastered the square stance and is moving on to the improving stage it is better for them to choose the stance that suits their body structure and them as an individual.



**The open stance**

When using the open stance it is good for the archer to broaden the width of the feet to be in line with the shoulders. If the direction of the waist is on the same line as the feet, the position of the bow shoulder is pushed backward making it difficult to maintain the power at full draw.



In case archers exceed more than 30 degrees the body weight is slanting forward and so the balance of power over the two feet becomes unsatisfactory, When the twisting of waist is too strong, the flexibility of the body comes to disappear and archers come to feel tension in the upper body.

Also movement takes place in the waist causing the bow shoulder and arm to shake making it impossible to produce a good shot.

The open stance, if done correctly can have an advantage in which the archer can have a feeling of stability in windy conditions.

## 2. Setup

Setup is a preliminary action before drawing the string and which affects many movements and conditions. Taking an accurate setup stance will help the body produce the correct stance at full draw.

### *The principle of the stance for producing a correct setup*

1. The correct position of the bow arm, and arm rotation.
2. An accurate positioning and fixing of the bow arm shoulder.
3. The correct height of the bow arm.
4. Maintaining the accurate body centre and alignment at the time of the setup.
5. Maintaining an accurate angle at the time of the setup.
6. Choosing the accurate position of the nape of the neck at the time of the setup.
7. Accurate breathing at the time of the setup.
8. Maintaining the flexibility of the joint of the drawing arm, also maintaining the angle.
9. Establishing the accurate balance of power between the drawing arm and bow arm.

10. Producing the proper arrangement and alignment of the lower body and the upper body.

### *The accurate position of the bow arm, and arm rotation*

The form of the bow arm is very important when pushing the bow at the time of the setup. An archer should rotate the bow arm extending the bow forward and lightly inward. In the case of the beginner, an effective practice routine is to lean the bow hand against a wall, or a similar fixed item. The shoulder of the bow arm can be fixed at an accurate location, but only when the bow arm is rotated inwardly. With this practice no change will occur in the shoulder position at the time of extending and a clean release can be produced.



### ***The fixing of the accurate position of the bow arm shoulder***

An archer should maintain the position of the bow shoulder produced at the time of the setup, then gently lower the direction of force during the draw. In this way they come to prevent the rising of the shoulder during the draw.

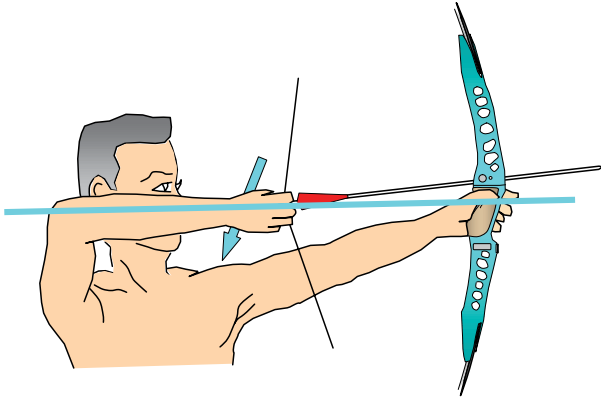

### ***The accurate height and position of the drawing arm***

The best height of the arm drawing the bow is somewhere between the eyes and lips (this must be defined personally by each individual archer). In this way an archer comes to maintain the height of the elbow when drawing a bow. This will also help to make the bow seem easier pull as the draw travels in the lower direction from the slightly higher original position. This will help to maintain the alignment of the arm drawing the bow, the arrow and the elbow, and keep a horizontal draw force line.

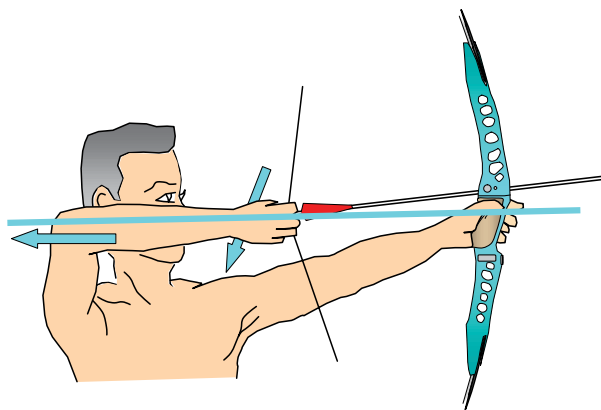

### ***Maintaining the correct centre of gravity of the body at the time of the setup***

When drawing a bow the archer should place the centre of gravity of the body over the centre of both legs i.e. if the centre line of the body was continued down to the ground this line would fall directly central to the position where the feet are placed on the ground.

**Note:** Some Coaches recommend getting the Centre of Gravity a little towards the toes, either by canting the entire body forward or by canting the top body from hips.

If this centre line is not positioned correctly a change will occur to this line when the archer draws the bow.

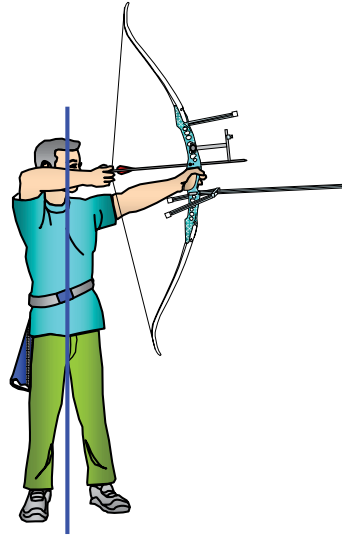

### ***Maintaining the correct angle of the body at the time of the setup***

When drawing a bow the archer should place the centre of gravity of the upper body at the centre of both legs, i.e. at the centre of gravity of the whole body. If this is not maintained while the archer draws the bow the body will lean and this will cause a change to the body's centre of gravity.

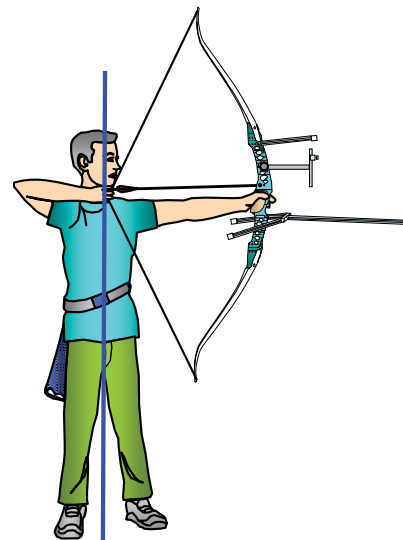



### ***Breathing at the time of the setup***

With respect to breathing, an archer may as well maintain natural state. However, at this time, respiratory tract should remain opened.

The choice of the accurate position of the nape of the neck: at the time of the setup.

The archer should properly face toward the target at the time of the setup. Many inconsistencies will occur, i.e. with the anchor (draw reference point), depending on the position of the nape of the neck that is chosen at the time of the setup.

### ***The flexibility of the wrist of the drawing arm, and producing a consistent angle***

The wrist of the hand drawing the string should always stay relaxed at the time of drawing the bow, and the straight line with the arrow should be maintained throughout the process of drawing the bow.

### ***The correct balance between the drawing hand and bow hand***

When drawing the bow it is better that the archer feels a balance of power of 50% on each of the drawing hand and pushing hand at the time of the setup. This will help in developing a technique of extending later.



### ***The proper arrangement of the lower body and the upper body***

The upper body and the hips should stay fixed during the time of the setup. If the relationship between the upper body and hips changes at this time it will effect many areas during the draw, or even, when at full draw. The archer's body position goes through many changes when

coming to full draw and it is imperative to keep these to a minimum.

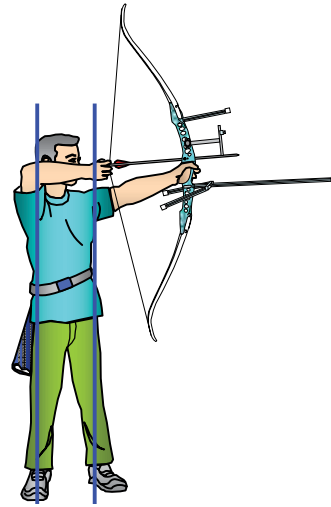

### ***Hooking (Placing the fingers on the string)***

Hooking (placing the fingers on the string) is an action that should be undertaken carefully and correctly. The finger tab should be correctly placed on the fingers and the string should be correctly positioned on the finger tab. If this is not done correctly many inconsistencies in the archers stance, including full draw and extending etc. can be affected and depend on the position in which the fingers and tab are placed on the string. If an archer has developed an incorrect finger position on the string it will be very difficult to rectify this mistake, therefore an archer should undertake to perfect this process without letting any errors develop.

### **3. The basic principle of hooking (Placing the fingers on the string)**

1. The position of the string which is placed on the fingers should be constant and a fixed location.
2. The distribution of the force on the fingers should remain constant at all times.
3. No force or strain should be felt on the joints of the fingers; they should remain soft and relaxed.
4. The wrist joint should be relaxed and no force should be applied to it.
5. The direction of force on the fingers should be constant and in the direction of the force of the bow.
6. When a bow is fully drawn and the hand reaches the anchor point (draw length reference point) the string may now be hung on the first joint of the fingers.

7. There will be a small difference in the position when the string is placed on the fingers; this is dependant on the length of the fingers of each individual archer.
8. An archer should choose a finger tab which is most suitable for the size and form of their fingers and which is comfortable to wear.
9. The direction of force at full draw should be in a straight line – from the tip of the drawing arm elbow, through the wrist and fingers on the string to the pressure point on the bow, this is known as the draw force line (DFL).
10. No tension should enter the thumb or little finger and they should remain relaxed at all times.

### ***The position in which a string is placed on the fingers***

The position where the string is placed on the fingers may well be on the first joint of the fingers. The prepared position of the fingers on the string prior to drawing the string may be well behind the first joint but when the drawing hand reaches the anchor (draw reference point) the string may now be in the first joint on the fingers. To achieve this string location at full draw it may be necessary, while at the prepared position, to position the string a little further down the fingers than the first joint.

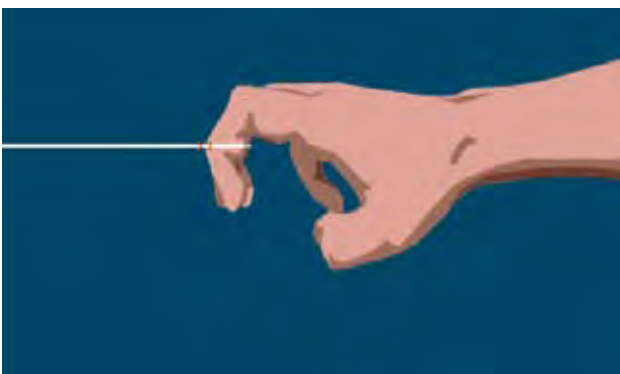

### ***The distribution of the force on the fingers***

The distribution of the force of the three fingers placed on the string should be naturally implemented. It will be very strenuous to consciously distribute this force and it will be difficult to effect natural release. Various inconsistencies within the stance can be caused by inconsistencies in the placement of the fingers on the string; this is caused by the change in force which is applied to the fingers that has taken place. If an archer masters the stance the distribution of force on the fingers will be realized naturally.

### ***The elbow of the drawing arm and the height of the arrow***

If the elbow of the drawing arm rises too high above the line of the arrow, the optimum line is just above the line of the arrow, the force on the fingers is inclined toward the ring finger (third finger). In the case of the elbow being inclined downward, lower than the arrow line, the force will fall onto the middle and third finger. The correct height of the drawing elbow is essential and will be helpful in producing the correct distribution of force on the fingers.

### ***Placing the string on the drawing hand fingers***

If the string is positioned too far along the fingers the force comes to be directed toward the ring finger, which forces the ring finger to press strongly on the string. This action makes it difficult to execute a clean release.

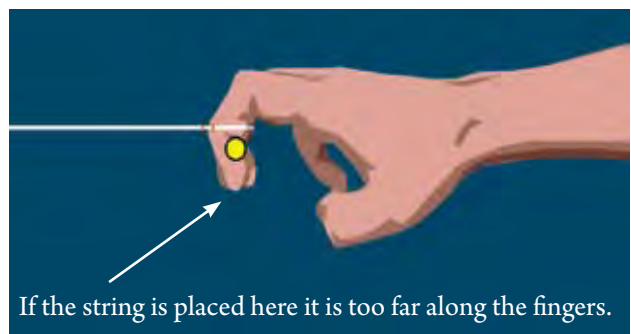
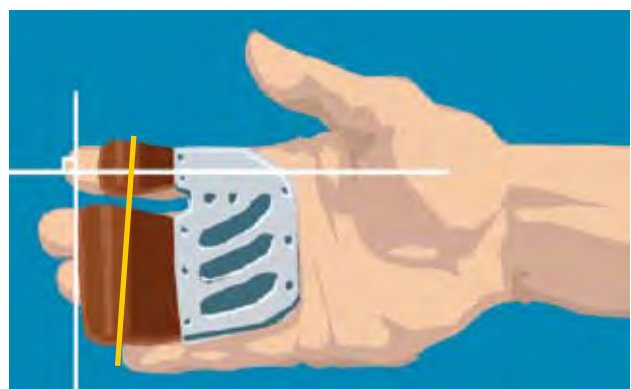

### ***The ration of force***

There should be very little difference in the ratio of force on the three fingers when drawing the bow, there will, however, be some differences which are dependant on the bone structure of the archer's hand and fingers. On average, slightly more force is applied to the middle finger; the next is the ring (third) finger and then the index finger.

### ***The joints of the fingers and wrist***

If tension is applied to the joints of the fingers and/or wrist stopping them from being relaxed and in a natural line, the force line of drawing the string does not reach the back muscles which restricts the action of extending the body into the shot. Also, if the tension is excessive in the fingers and wrist the distribution of force is not even and the direction of force cannot be accurately performed.

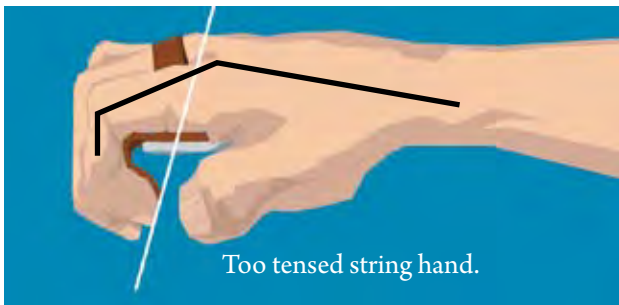

### ***The direction of the force on the fingers***

The direction of force on the fingers from the time of drawing the string to the process of releasing is very important. The muscle tension required to keep the fingers of the drawing hand on the string should be just sufficient to maintain control of the string. The position and action of the elbow has a direct bearing on the action, and reaction, of the bow. If when at full draw the string is too far down the fingers all the force is focused on the fingers, and; If too much tension is used it will be difficult to execute a clean release.



### ***The use of a finger tab***

The finger tab can significantly affect an archer's performance, this all depends on the quality, the material and form, and they all can affect the archer's control. There have been cases where fingers have been injured because of an ill fitting or damaged finger tab. The material of finger tabs should be consistent and efficient, even if it is used for a long time. The archer should also choose a material that does not change in quality during inclement weather. Also, if the archer uses a multi layer tab it can help to reduce the possibility of injury to the fingers.

### ***Placing the drawing fingers on the string***

The fingers drawing the string should not put undue prssure onto the nock of the arrow. The middle finger should not touch or raise the nock as this would force the nock into a false position and cause inconsistencies in the arrow pattern on the target. The top finger should softly touch the top of the nock when the archer has come to the full draw and reached the anchor point (Draw reference point).



## **4. The Grip (hand position on the bow)**

The position of the grip is the most central position of a bow; this and the hand pressure on it exerts a great deal of effect on the direction in which the bow moves at the time of the shot. The entire force of a bow, i.e. the upward and downward balance, is in accordance with the direction of force and the position of the bow hand and its contact with the bow grip. In particular, as a clicker (draw length check) is introduced, a lot of changes occur in the direction of force at the time of extending the draw force line to complete the shot. Therefore, an archer should master the accurate hand position on the bow grip which is compatible with their physique and stance.

### ***The basic principles of the hand position and bow grip***

1. The hand position on the bow grip should become a constant and natural position for every shot.
2. The direction of force of the hand pushing the bow grip should not be biased up, down or left or right but directly forward and on the centre of the bow grip.
3. The archer should feel a natural and comfortable hand position on the bow grip, they should also feel, and keep, the stability in the shoulder bow and arm as the body is extended to complete the shot.
4. There should be little or no force exerted on, or by, the fingers of the bow hand as the pressure is increased on the bow grip to complete the shot.
5. There should be no change in the direction of the force on the bow grip at the time of extending.
6. The hand position on the bow grip should not slip to either the left or right at the time of extending.
7. The fingers of the bow hand, once set, should not move during the time of extending.

### ***The height of the bow grip***

The height of the bow grip can differ from bow manufacturer to bow manufacturer or from model to model. Therefore, archers should choose a height of bow grip that suits their hand, bone structure and shooting form. Whilst the archer draws the bow and the hand pressure increases on the bow grip the force of the hand should be in the lateral centre of the bow grip and at place lower than the vertical centre of the bow grip. At this time, the direction of force should not move up or be inclined to the left or right. Whilst in the early stages it may be worthwhile placing/attaching something to the bow grip to help the archer locate a constant position for their hand, it should be positioned to suit their individual style.

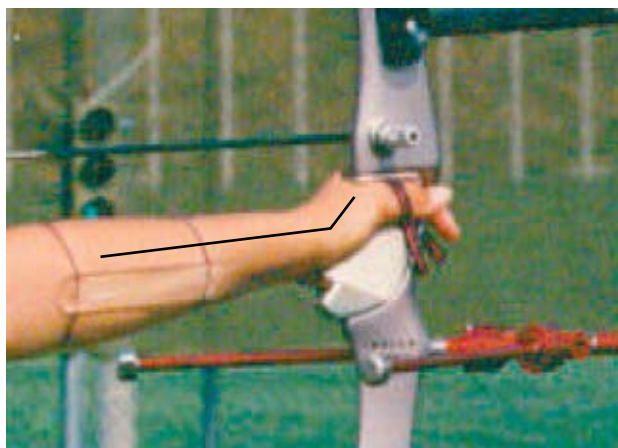

### ***The position and condition of a stabilized bow hand***

1. The archer should be able to feel the most comfortable hand position when they draw their bow.
2. The archer should feel and sense the central part of the hand as it contacts the central part of the bow grip.
3. There should be no force exerted on the wrist which jeopardises the bow hand position on the bow grip
4. When the archer draws a bow they should have a natural sense of feeling with the bow hand and shoulder line.

### ***The form of the fingers of the bow hand***

Archers should let the thumb and forefinger bend in a way that is natural to them. If archers unfold their thumb and forefinger the muscles of the centre of the fingers become unnatural and unwanted force may be introduced to the wrist. It also is advisable for all the other fingers to be relaxed and maintain a natural state whilst executing the shot.



### ***The direction of hand pressure on the bow grip***

A great variety of changes can take place, many of which are dependant on the direction of pressure the bow hand exerts on the bow grip. The direction of this pressure influences the right and left position of an arrow when aimed at the target. The consistency of this pressure location is very important because even a small change can have an effect, it may even cause changes occur to, the DFL (draw force line) i.e. the bow grip, bow arm, the arrow, and drawing arm.

1. The direction of the force should be placed between the thumb and forefinger and this central part should be placed in the centre of the grip of the bow.
2. The hand being placed on the centre of the bow grip should be placed there gently and in precisely the same position each time.
3. The thumb and forefinger of the bow hand find their own position naturally which is usually directed slightly inward. At this time, the thumb and forefinger



should face slightly forward and the force exerted by the pressure of the bow should result in them slightly coming together. The division of force on the thumb and finger should be equal at 50%.

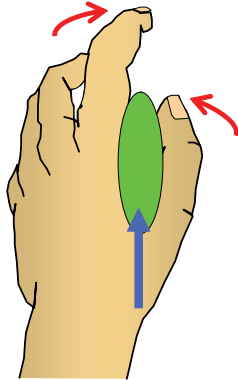

### ***The palm on the bow grip***

The left part of the palm (A) on the bow hand should not touch the grip part of the bow. The palm should face the ground. In situations where the palm becomes vertical i.e. the same plane as the bow, archers cannot turn the bow arm inward which results in the arm and shoulder not being located correctly, and it is difficult to achieve a good angle in the full draw position. With the direction of the hand located on the grip being inclined to the left, it forces the centre line of the body to be inclined backward.

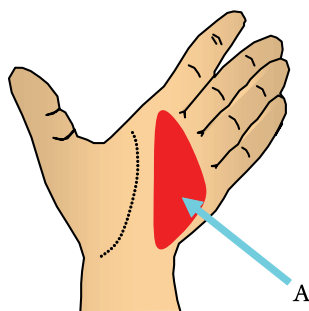

The centre of the bow grip should always be the pushing pressure contact point. If the Bow hand slides up the grip during the draw the bone of the palm (B) becomes the pushing pressure contact point. As this is lower than the centre of the grip undesirable changes to the archers form and movement of the bow will occur at the time of shooting.

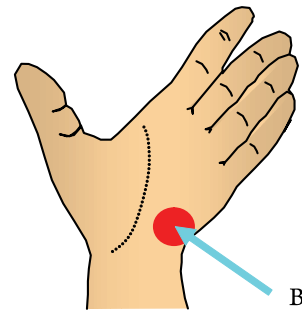

### ***The use of a bow sling***

Getting a beginner to use a bow sling is very important. If a beginner does not use a bow sling they become to develop the habit of holding the bow with the bow hand. This is not a good habit and should be discouraged. When the beginner takes hold of a bow unwanted forces are introduced into the muscles and they start to energise, when this happens movement occurs in the bow arm. Therefore, from the outset, a beginner should use a bow sling so that they can maintain the direction of force which pushes on the central part of the bow grip with the bow hand.

### ***Kinds of bow sling***

There are various kinds of bow slings; however, we give the preference to the finger sling. The reason is that when using a wrist sling the bow movement can be excessive, and the bow moves up and down, and right and left at the time of shooting. However, when a finger sling is being used the grip pushing a bow can face the centre of a target, and the archer can have a feeling in which the bow and bow arm extend freely toward the target at the moment of the shot. The finger sling should be placed between the forefinger and the thumb. If the archer places the finger sling between a middle finger and the thumb the direction of the face of the palm on the bow hand changes at the time of shooting, this would cause a change in the direction of the force of the pushing bow arm.



## 5. The action drawing the bow

- 5.1 Drawing speed.
- 5.2 Drawing direction.
- 5.3 Drawing balance.
- 5.4 Body stance at the time of drawing.
- 5.5 The movement of the centre of gravity at the time of drawing.

### 5.1 *Drawing speed*

When drawing the bow, the archer should draw it evenly and slowly. If the bow is drawn too suddenly and at a speed that is unnaturally fast unwanted force enters the muscles and the body becomes rather rigid. The speed of drawing a bow should become a natural feeling and compatible to the feeling when taking up the original stance. This speed should be where the archer can control the sense and feeling within the muscles. The entire motion of drawing a bow should be fully controlled and realised in a rhythmic action.

### 5.2 *Drawing direction*

The line of force and line of direction at the time of the setup should be maintained. The direction of the drawing hand should not move either up or down when drawing the bow. Neither should the drawing hand wander into or away from the bow arm during its travel when drawing the bow. The line and direction of force should be; from the centre of the target, through the bow hand to the drawing hand. This line should not deviate up, down, left or right during the action of drawing the bow.



### 5.3 Drawing balance

When drawing a bow a 50% balance should be maintained between the drawing arm and the pushing arm.

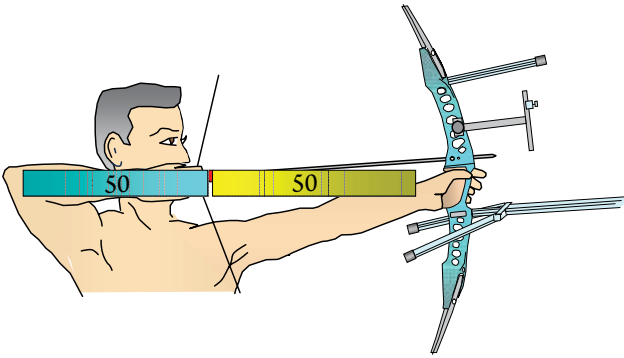

### 5.4 Body stance at the time of drawing

1. You should make sure that when drawing a bow the shoulder of the bow arm does not raise up.
2. You should not bend your body at the waist.
3. When drawing a bow you must maintain the original body stance where the upper and lower body are in line.

#### *The movement of the centre of gravity at the time of drawing*

If there is a change in the centre of gravity due to an incorrect body alignment at the time of setup, the whole body centre of gravity will be in error when the bow is drawn.

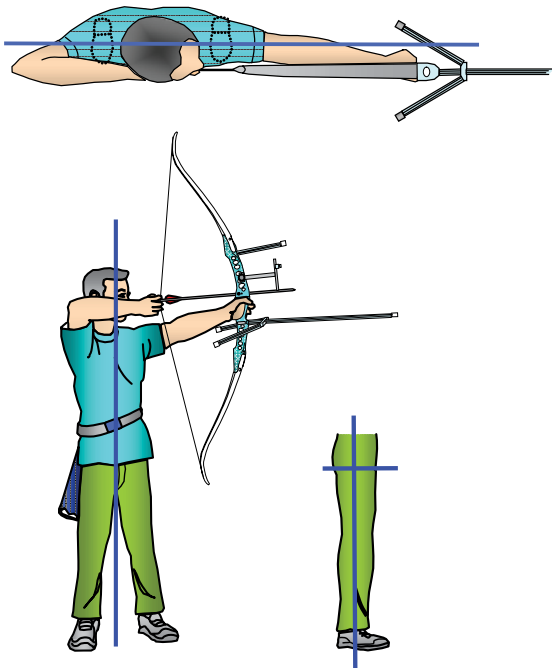

Note: Some Coaches recommend getting the Centre of Gravity a little towards the toes, either by canting the entire body forward or by canting the top body from hips.

## 6. The Anchor (Draw reference point)

The anchor (draw reference point) is the most important of all the basic skills. The reason for this is the anchor is the central position of the “pushing” and “pulling” points when in the full draw position. Depending upon the positions and methods of the individual archer’s stance, (various stances are influenced in many ways), they should master the method of reproducing an accurate anchor position right from the start when learning archery.

- 6.1 An archer should perform the anchoring action by using the elbow, rather than using the muscles of the arm to draw the string hand to the chin. If an archer performs the anchoring action without using the elbow, force will enter the wrist, and a stable anchoring position will not be achieved.



*The height of the anchoring elbow.*

- 6.2 The elbow should be higher than the horizontal line of the arrow then the drawing hand can be completely fixed in the correct, predetermined, location on the jawbone. However, caution should be taken if the third finger is short and not getting a good position on the string, it will be possible for this finger, or even the whole hand to slip from the string.



### ***The position of anchoring.***

6.3 The string may be located a little to the outside of the face rather than at the centre of the chin. However, at this time the string should be positioned at the centre of the nose. If the string is positioned to the right (for a right handed archer) and away from the centre of the nose, the string could be seen aligned out of the internal jaw of the sight window of the riser (requiring another head orientation). However, when at full draw, anchoring slightly to the side of the jawbone will help produce a good release due to a better “draw force line”.



*The drawing hand in the anchoring position.*

6.4 When the drawing hand is in the predetermined anchoring position and the string is located at the jaw, the archer should continue pushing with the bow-hand. While performing the extending motion, the location of the string on the face should be maintained, this will help to produce a good release when the clicker activates and reduces the likelihood of making a poor release.

## **7. Full Draw**

Having a good body position at full draw is the most important element of making a good shot. The angles of the body can vary in accordance with many physical characteristics of the archer. Therefore, there can be minor differences in the basic techniques in accordance with each archer’s physique when taking up the correct angle when at full draw. The stance when at full draw is very important as it is the final stance before losing the arrow. After the archer has mastered adopting the correct stance at full draw the archer should begin to train and perfect the release.

### **7.1 The correct body stance at full draw**

When at full draw it is important to stand erect and that the body is straight.



If the body is leaning or bent at this time, as in the picture below, the pushing arm shoulder will have a tendency to rise. In such a case the pushing arm, arrow and drawing arm will not be in a vertical line but will lean at a similar angle to that which the body has adopted.

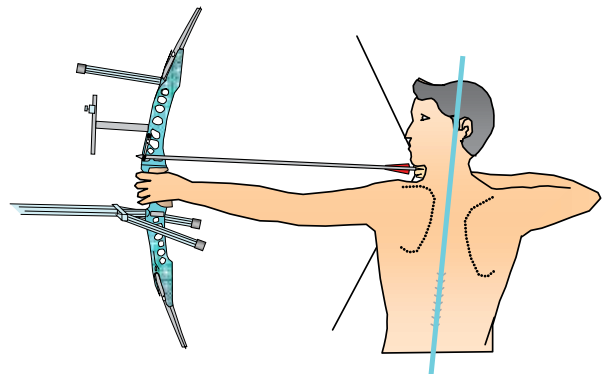

### **7.2 The full draw position as seen from the front**

The centre of the grip of the bow hand, the position of the anchored hand and the elbow of the drawing arm should all be in a straight line. The elbow of the drawing arm should be at a higher plane than the line of the arrow, and the shoulder of the pushing arm should be lower than the line of the arrow. If at this time the shoulder of the pushing arm is higher than the line of the arrow it will be difficult to use back tension, and the shoulder will continue to rise during the extending phase.





### 7.3 *The position of full draw as seen from above.*

When in this position it is good for the shoulders to be parallel with the line of the arrow, see picture below. When in this stance the arrow should be in close to the body. It is important to have a straight line from the grip of the pushing arm through the fingers of the drawing hand to the elbow of the drawing arm. At this time though, it will be acceptable for the drawing arm elbow to be positioned a little behind straight drawing line. The upper body should be central and vertical to the stance, if it is not positioned in this way the centre of gravity of the body will move at the time of extending causing inconsistencies to the shot.



### 7.4 *The position of full draw as seen from behind.*

The drawing shoulder blade should be lower than the pushing shoulder blade at the time of full draw, see picture below. The shoulder of the pushing arm should maintain the pushing state while the drawing shoulder continues a strong drawing action. Performing this action will develop the correct balance and back tension, and develop a good release at the time of extending.

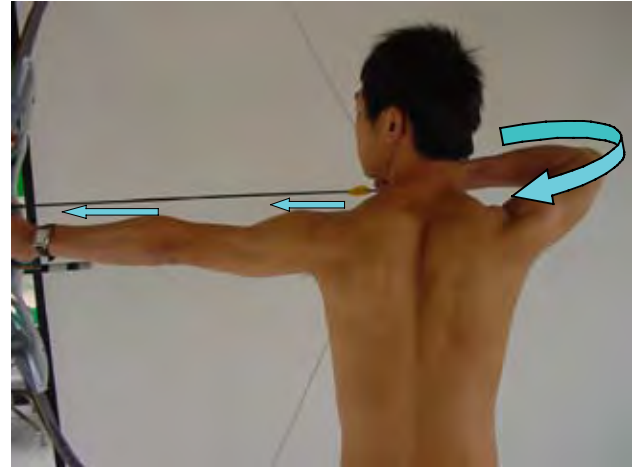

### 7.5 *The inclining of the bow at full draw.*

At the time of full draw the bow should be vertical and not canted left or right. The position of the string and the direction of arrow flight will be different if the bow is canted at the time of aiming and loosing. This is usually caused by the upper body leaning one way or the other taking the bow to a similar angle to that the body has taken up, so special attention is needed to ensure the stance and body position is correct before completing the shot.



### 7.6 *The inclining of the body at full draw.*

If the centre line of the body is leaning or inclined at the time of full draw, the archer will have difficulty in effecting a perfect shot. An archer should develop a vertical and proper centre line as they come to full draw and maintain this line through the time of extending and releasing.

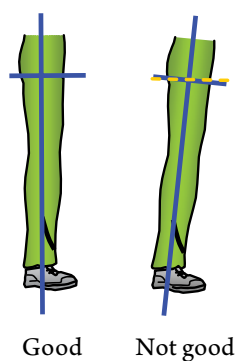

Good

Not good

**Note:** Some Coaches recommend getting the Centre of Gravity a little towards the toes, either by canting the entire body forward or by canting the top body from hips.

## 8. Extending

Once the archer has mastered the basic skills of shooting, the archer should then master the skill of using a clicker. It is very important that an intermediate archer learns how to use and control the operation of the clicker correctly. Accurate balance, correct use of the muscles and the steadiness of extending are very important.

Perfecting the basic stance is essential before moving on to mastering the method of accurate extending, the archer should have a good foundation in the stance if they are to master the art of producing a good technique in extending.

The time of using a clicker and the important points before using a clicker.

An archer should not start using a clicker until they have completely mastered consistency in the art of producing the basic stance.

The release should be correctly mastered before using a clicker, if it is not, it is very difficult to correct a bad release after introducing a clicker.

An archer should have sufficient power to be able to draw the bow comfortably and efficiently. If the bow is too powerful for the archer they tend to complete the extending action by using the fingers of the drawing hand, or by introducing unnecessary use of other muscles.

The archer should be correctly measured for the arrow that they will be using with the clicker. The length of the arrow should be measured when the archer has drawn the bow correctly and whilst the archer is in the full draw position.

## 8.2 Methods of using a clicker.

8.2.1 The method of looking at the arrow point whilst the archer is drawing the arrow.

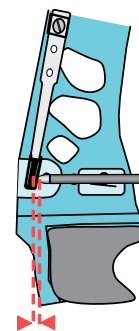

3 to 5 mm

- The archer watches the arrow point whilst drawing the bow until it is approximately 3 to 5 millimetres from the front of the clicker.
- Whilst keeping an eye on the clicker the archer should also make sure that the sight pin is positioned on the centre of the target. The archer should also be cautious at this time and not let the arrow pass through the clicker until they are totally ready.
- Whilst maintaining the sight pin on the centre of the target the archer should be extending continuously.
- When the arrow point activates the clicker the archer commences the release, this should not be delayed but should be completed in a natural and relaxed action.

**Strong points:** The archer comes to full draw being aware of the arrow point and clicker relationship. In particular they see the arrow point nearing the position of activating the clicker which develops a fixed draw length and helps producing a constant extending time.

**Weak points:** When the archer comes to full draw and their vision moves from the arrow point to the sight pin, a phenomenon occurs where full draw pressure is relaxed and the arrow creeps slightly forward. To counter this, the archer must actively continue the extending action in a continuous motion.

8.2.2 The method of drawing the bow without looking at the arrow.

The archer should select the correct length arrow before using this method. To determine this, the archer should close the eyes and come to full draw; the arrow length can then be measured when the archer is extending comfortably. This should be practiced several times to ensure the correct arrow length is obtained.

The archer draws the bow until the arrow is approximately 3 to 5 millimetres from activating the clicker, at this point the emphasis is to concentrate on aiming at the centre of the target.

The archer continues the act of extending while maintaining the concentration of aiming at the centre of the target.

**Strong points:** The archer can easily feel their own senses, and the continuous action of extending can be easily performed.

**Weak points:** An inconsistent draw length may occur as a result of the archer's physical condition; even the climate or wind conditions may influence the archer's ability to achieve a regular and constant draw length.

### 8.2.3 The method of effective mastering the use of a clicker.

When first using a clicker the archer should start by watching the arrow point. When the archer has mastered this method and the draw length becomes constant, as a next step, it will be more effective to select the method of using a clicker without looking at the arrow point.

8.2.4 In the case of young archers, and depending on their age and height, their draw length should be checked regularly, possibly every 3 to 6 months. Their height, arm length and shoulder width may all change at differing times but they can all have a bearing on their draw length. Their arrows should be kept long to allow for this change in their physique and possible draw length.

### 8.3 The balance of extending

Producing a good balance of power at the time of extending is a very important archers' skill.

The distribution of the power of pushing, and drawing, should always be constant. In the case of beginners, it is good to produce a ratio of 50% pushing and 50% drawing. Depending on the individual archer there will be a small difference in the distribution of this power; however, it is important that no matter how small this difference is it should remain constant. Care should be taken that the distribution of power at the time of extending remains constant, even if the time of extending varies. This is because the distribution of power is constant when the extending time is short, but the balance of power may change when the extending time becomes a little long.

### 8.4 The direction of extending

The direction of extending should remain constant at all times. The pushing arm should correctly push from the pivot point of the arm, and the elbow of the drawing arm should maintain a direct line of movement in the opposite direction.

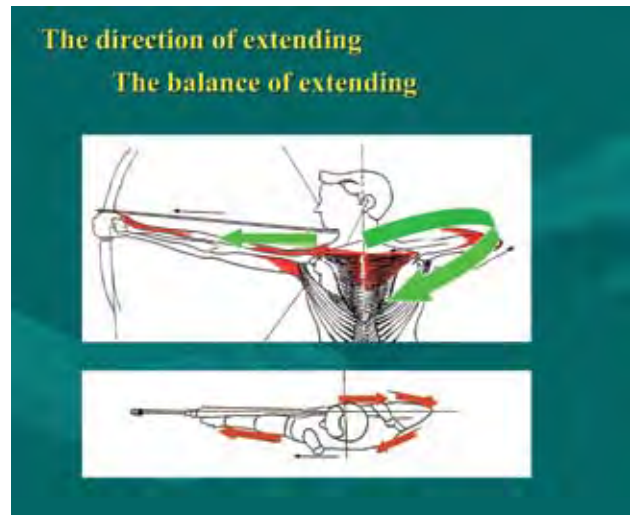

### 8.5 The areas to be cautious of at the time of extending

- An archer should not execute the extending action by using the fingers



- No change should take place in the position of the anchor at the time of extending.
- All fingers should stay on the tab and not slip off at the time of extending.
- The drawing elbow should not be lowered at the time of extending.
- The shoulder of the pushing arm should not move upward at the time of extending.
- The pushing hand on the bow grip should not move to the left or right at the time of extending.



- The wrist of the pushing bow arm should not move upward at the time of extending.
- No change should take place in the location of the string at the time of extending.
- The bow should be vertical and not inclined left or right at the time of extending.
- No change should occur in the balance of the pulling and drawing power at the time of extending.
- No change should occur in the direction of power at the time of extending.
- No change should take place in the centre line or centre of gravity of the body at the time of extending.

## 9. The release

It is essential that the archer develops and masters the release either in the beginning or intermediate stage of their training, as it is very difficult to correct the release later. In particular it is essential that the archer masters the release before using a clicker as they can concentrate on, and master, the release before having to control the clicker as well. However, once the archer begins to use a clicker they tend to concentrate on this and neglect the action and motion of the release. This sometimes gives rise to the archer making a false release by consciously opening of the fingers. The release should be natural and follow the line of power that the archer developed before being introduced to the clicker. The position where the release begins should be at the end of the action of coming to full draw and at the beginning of when the extending action is being performed. If there is any deviation from this place where the release begins errors will be introduced into the performance of the shot, and the inconsistencies introduced will degrade the efficiency of the shot.



### 9.1 The direction of the release

The direction of the release should follow the line from the back of the arrow and along the power line which is just under and along the jaw bone. If at the moment of release the fingers deviate from this line, either into or away from the jaw, the fingers will leave the string in a false location forcing the arrow to deviate from the correct line of flight.

### 9.2 The speed of release

The speed of the fingers releasing the string is very important. The relationship of time when the clicker falls from the arrow point to the moment of the release is also very important. It is found that if there is a delay this is the moment where most of the mistakes take place. It is important that the release is perfected so that the time and speed of the release stay uniform and constant.

### 9.3 The distance of finger travel during the release

The distance of finger travel during the release should always be constant. It is not necessary for the distance of travel to be any further than from the position of the fingers at the anchor (draw reference point) to just below the ear. If the distance of travel is too short it is possible for the releasing hand fingers to be drawn forward producing a forward loose, and if the travel is too far it can produce a sudden unwanted body movement.

### 9.4 The use of the back muscles at the time of the release

The archer should have a controlled release at the time of extending while maintaining the power and pressure across the back muscles. In order to achieve a good release, the power at the drawing arm elbow should be maintained whilst the release is being performed. If ten-



sion enters the drawing fingers at the time of extending the release will be a false one and not controlled or efficient.

### **9.5 The form of the fingers at the time of the release**

There should be no increase in tension of the fingers of the drawing hand to help effect the release. It is important that the muscle power controlling the fingers of the drawing hand should just be relaxed at the time of the release, and the fingers should remain relaxed during the follow-through.

### **9.6 The inspection of the finger tab**

Archers should regularly inspect the surface of the finger tab for wear; this is to ensure the release stays constant and efficient. This can also show the area of finger pressure on the tab and the line the string takes across it, and it can give an indication on the state the release. This will be evident by the wear pattern – whether it is wearing evenly or partially in a particular area.

## **10. Follow Through**

Maintaining the stance after the release is very important; not only the stance, but also the form, the visual, mental and breathing activities. The archer's mental preparation and thoughts of executing a good follow through will help in producing a good release, this has the added benefit of helping to execute and perfect the process of extending.



### **10.1 Maintaining the direction of power.**

During the process of release and follow through the drawing hand should continue along the line of power that was set-up during the extending procedure. This line is from the pressure point on the bow pushing hand, through the drawing hand fingers where they are located

on the string, to the point of the elbow of the drawing arm.

### **10.2 Maintaining the vertical centre line of the body**

During the action of the release and follow through the archer must maintain the vertical line of the body. If the body deviates from this central line the body will shake at the time of release and unwanted movement will be introduced.

### **10.3 Sustaining the use of the back muscles.**

The muscles of the back should not be relaxed rapidly at the time of the release. Errors during the completion of the shot may occur but can be prevented when the back muscles are able to continue their operation during the release and follow through. This will also help the archer to perform a good shot whilst in a stress situation.

### **10.4 Maintaining an accurate balance**

An archer should establish and maintain an accurate balance during the time of the release and completion of the shot. If this balance is not maintained it is likely that the pushing arm will shake or the drawing hand becomes unsteady and the shot being performed will not be fully efficient.

## **11. Breathing**

### **Breathing**

The best method of breathing when shooting a bow is the archers own natural pattern. However, it is the timing of breathing in and of breathing out that has to be controlled. It is recommended to develop a breathing sequence to be applied in parallel of the technical (movement) sequence and the visual sequence.

#### **11.1 Set**

This is the time when the archer is going through their preparation routine for drawing the bow. During this time the archer is breathing naturally and in their normally way. However, during this time of the shot the archer may become tense, their pulse rate increases and their breathing becomes irregular. At this time the archer should endeavour to maintain their regular breathing pattern.

#### **11.2 Setup**

The archer should breathe in during the time of setup but slightly differently from their normal way of breathing. If

at this time the archer breathes letting their chest expand when they breathe in, the chest expansion causes the upper body to incline backward. Therefore, the breathing should be controlled by the abdomen—breathing at approximately 70 to 80% capacity; this will leave the upper body stable and unaffected by the breathing action.

### **11.3 Drawing**

At the time of setup the string would have been drawn to approximately 70 to 80% of the full travel, (this point can be different for each individual archer and depends on their own shooting technique). At this point the archer breathes out slowly while drawing the string the rest of the way to the anchor point (draw reference point). By the time the archer's drawing hand reaches the anchor point they should still have 20 to 30% of air left in the lungs.

### **11.4 Anchor**

The action of breathing is suspended while the archer is in the anchoring position. This suspended state should continue until the shot is completed although the respiratory tract should remain open. After the shot has been completed the archer should return to their normal breathing pattern.

## **12. Shooting in the wind**

### **12.1 The phenomenon that takes place when shooting in windy conditions.**

#### **12.1.1 The changing location of the arrows landing in the target.**

As the wind intensity and pressure fluctuates the arrow flight and location it strikes the target will be different from a shot performed under calm conditions. Even though the arrow pushed by the wind may hit the same location, the location the archer aimed the shot and the position of their body will possibly be different from shot to shot. Even if the archer shoots each arrow with the same intensity and power the aiming position will differ from shot to shot. However, in windy conditions, it is impossible to calculate mathematically where the aiming point should be to have the arrow strike the centre of the target. Because the conditions, including the field of play, will be different for each event the archer should select the position for their aiming point by comprehensively analysing the situation as each condition presents itself.

#### **12.1.2 The changes in the flight of an arrow.**

During windy conditions the flight of the arrow is different to the flight of the arrow in calm conditions, and these differences need considering. Especially before the contest begins, this is when archers become very sensitive to the conditions and possibly become doubtful about their own ability and uneasy psychologically. Archers should abandon the thought that only their arrows are affected by the wind, everybody's arrows are affected by the wind. During windy conditions the arrow's direction and flight cannot be fully predicted, and so the archer must generate the confidence that they can shoot good shots in the wind. The direction and balance of correct shooting, including the follow-through etc. will help guide the arrow to hit the desired location. There are times when an archer makes a mistake and the arrow, being pushed by the wind, actually hits the centre of the target. Therefore, it is important not to be afraid of the wind but accept it and prepare for it.

#### **12.1.3 The effect the wind has on clothing.**

During windy conditions clothing can flutter, particularly the sleeves; if this is excessive the sleeve may move into the path of the string causing it, and the arrow, to deviate from its true path. When the windy conditions are excessive the clothing movement can be extreme and can emit fluttering sounds, and may cause the archer's body to even shiver or tremble, so the archer should be cautious about the choice of clothing and select the right clothes for the right conditions, as is done when it is sunny, warm or raining.

#### **12.1.4 Making a change to the centre of the body.**

When the wind condition is extreme, a change occurs to the centre of gravity. This occurs because the body resists by leaning toward the wind no matter which way it is coming from. There are occasions when, the power or direction of the wind may not be constant, and the centre line of the body shakes or continues to move in accordance with the direction and power of the wind. As this causes various problems including sighting or holding, the archer could lower the centre of the body (the lower abdomen). Though, the archer should be careful when doing this for the upper body (chest) may float upward at the time of setup when preparing the stance.

### 12.1.5. The direction of the bow arm.

When the conditions are calm or the wind is not blowing, the arm pushing the bow and the centre of the grip always corresponds to the centre of the target. However, during windy conditions, the deviation of moving the bow arm is not constant and is dependant on the intensity and direction of the wind, along with, the archer's ability to maintain their form during these conditions. At this time the location of the sight on the target could be floating around the red/gold area when the arrow activates the clicker, and the release is made when this movement is taking place. This could cause the archer to make a mistake which would influence where the arrow lands in the target because the arm pushing the bow will resist in the opposite direction of the wind. The power of movement gradually changes in accordance with the power and direction of the wind causing a collapse in the balance of holding. The archer is influenced by this change of power and tends to modify their rhythm and balance to compensate for the disturbance and a poor shot is often produced. The archer being adsorbed in concentrating on the arrow hitting the centre of the target, often ends up by throwing the bow arm in an endeavour to force the arrow back on line.

### 12.1.6 The change in holding time.

As the method of contest changes, and the time the archer has to shoot their arrows reduces, the whole time of the shot is reduced. This in turn reduces the time the archer has for each element of setting up the shot, consequently the extending time can be significantly reduced. In windy conditions the extending time naturally increases which creates problems as it becomes difficult for the archer to exercise the release in their normal and confident manner. What is most important is that the archer produces a short and confident extending time after fully mastering the ability of producing a stable platform.

Remark		2 Seconds	3 Seconds	4 Seconds	5 Seconds	6 Seconds	7 Seconds
Before correction	Uneasy	Stable	Stable	A little uneasy	Uneasy	Quite uneasy	Urgent holding
After correction	Uneasy	Stable	Stable	Stable	Stable	A little uneasy	Uneasy

### 12.1.7 The change of extending time.

When the clicker is activated in accordance with the archer's natural or favourite time their own left and right balance is accurately accomplished. However, in windy

conditions the bow arm and body shake, and the holding time, becomes extended and a change in the balance of extending occurs. This takes place because the archer activates the clicker differently from their normal time in order to produce a fast release. Because of this occurrence the equilibrium of the balance becomes uneven, the distance of extending is reduced and the power of balance collapses. Therefore, the best way to master shooting in the wind, even if the extending time has increased, is for the archer to continue to make sure the original balance is maintained.

### 12.1.8 The decrease of physical power.

When the archer tries to resist the wind, the holding time becomes longer than the archer's natural time, and the degree of fatigue of the prime muscles increases. When this occurs the physical power is reduced and the archer feels tired. This tiredness will have a direct bearing on the archer's concentration which will be significantly reduced.

### 12.1.9 Estimating the distance of "aiming off" for the power of the current wind.

During windy conditions the archer becomes apprehensive about where they should aim to get the arrow to land in the centre of the target. It is difficult for an archer to remember all the peculiarities about the wind along with the direction and intensity. So they estimate a position where they should aim their sight by judging the situation of the wind and conditions for each contest. An archer also develops a "feeling" about the conditions at a contest and comes to rely on each new "feeling" as they arise. There are times when an archer actually hits the point where they placed their sight even when the wind is blowing quite strongly, and conversely, sometimes the release may be conducted when the sight is further out from the point where the archer wished to release the arrow, and still the arrow lands in the centre of the target. Because of these problems there are many occasions where an archer loses their judging ability and competes in the contest without having any confidence. The wisest way for an archer to cultivate the habit of making an accurate judgement, of how far to aim the sight off the centre of the target, is by believing in their judgement and ability during the contest and to produce strong and powerful shots.

### 12.1.10 When the wind is gusting or suddenly begins to blow.

There are archers that do not like shooting in the wind and become uneasy because of it. The wind can induce an archer to make mistakes which in turn reduces their overall performance. It is possible that these archers will lose confidence during a contest and fail because of the wind. However, the wind also causes other archers, in the contest, to make errors; it is the archer that makes the least errors that wins the contest. Just believe the wind is the goddess of fortune for you. You will find that if you develop the thought that the wind will be favourable to you, and if you do not let the wind worry you during normal practice time and practice in the wind, the uneasiness of shooting in the wind during a contest will soon be overcome.

### 12.1.11 When change of team tactics during a team round contest.

When the wind blows during a team round the archers must forget what each of the other members in their team has to do and not become worried as to whether one of them will make an error due to the wind. The archers should not give each other any advice about how far to aim off from the centre of the target as all archers and equipment perform at different efficiencies, if advice is given this could become counter productive and cause unnecessary errors. An archer's observation of the flight of an arrow and making a judgement about how far they should "aim off" from the centre of the target can be a great help in executing a good shot, but it must be their own decision without any other archer's input. If an archer gives advice but makes an error themselves, the archer following them will become unclear of where to aim and will possibly make a similar mistake. In a team contest the best method of leading a team to success, is for each individual archer to exercise the maximum concentration on their own performance. During a team round the team coach must also be aware that if they give a piece of advice, of where to aim, directly to an archer this could put doubt in their mind. This could interfere with the archer's concentration and produce a reduced performance.

Also, when the wind is blowing the archers in the team should pay attention to the order of shooting. It is good practice to decide the order of shooting which will be most effective; this order may be different when it is windy to that when the weather is calm. This differing shooting order should take into consideration all the traits of the

three archers. It is essential to consider all aspects including: the psychological well being, the extending time and the ability to adapt to the wind etc. of each archer.

### 12.2 *Measuring the archer's ability to adapt to controlled aiming in the wind.*

The coach must know the archer's ability, method and habit to adapt to "aiming off" from the centre of the target in windy conditions before introducing this procedure.

#### 12.2.1 Ability and consistency of the point of "aiming off" from the centre of the target during windy conditions.

In conducting the "aiming off" sighting procedure there will be times when the archer will be uneasy or even uncertain, and will make many errors. If an archer makes a sight change in advance of considering all the elements the arrow will not land in the centre of the target. Now, if the archer uses this information and "aims off" in the opposite direction by a similar distance that the arrow landed from the centre of the target, it is likely that the next arrow will now land in the centre of the target. If the archer calculates the measurement by changing the direction of the shot i.e. "aiming off", the coach can identify the archer's problems and can implement a training routine to remedy the situation.

#### 12.2.2 Considerations regarding how much to "aim off" from the centre of the target.

1. To what extent do you "aim off"?
2. Should you "aim off" for these conditions? If not, why not?
3. What direction and aiming point would give most confidence to hit the centre?
4. What is the direction of the wind that you dislike most?
5. What is the direction of the wind at the time of "aiming off"?
6. What is the direction of shooting at the time of the release?
7. What is the archer's general picture whilst observing the wind at the time of "aiming off"?
8. How much is the deviation of distance between the place the arrow landed in the target and the position the archer expected the arrow to hit by "aiming off"?
9. Considering the above situations, the archer may develop a psychological problem when confronted with a tricky wind condition during competition time.



1 2.2.3 Measuring the judgemental ability regarding the direction of the wind.

During windy conditions, the archer discusses with the coach the strength of the wind and where they should aim and release to get their arrow to hit the centre of the target. If the intensity and direction of the wind is calculated by means of the above method, to a certain degree, the coach can identify how much deviation and judgemental ability the archer has and develop this area during their normal training period.

1 2.2.4 Observing the archer’s extending time.

If an archer takes note of the direction of holding power, balance and the change of stance etc. when the holding time is lengthened as a result of the wind, they can counter many problems. With this knowledge an archer can prepare for windy conditions through adaptations to their training routine. When an archer shoots quickly because of windy conditions it is likely that they will introduce many errors, this in turn will affect their mental preparation psychologically and make them uneasy. Therefore the coach should anticipate and identify this condition advance, and supplement the archer’s training routine by incorporating and practicing the necessary skills.

1 2.2.5 Evaluating the psychology of the archer.

A coach needs to know, in detail, the psychological state an archer when they shoot normally, and any psychological change when they “aim off” during windy conditions. This can be done by consultation or by questionnaires. Some archers may find it difficult to speak about this condition or their method of dealing with it because of their pride. However, it is imperative that the coach discovers everything about their archer’s method of “aiming off” and the effect this has on them psychologically as this will become a great help in preparing for the next contest.

**1 2.3 Methods of training in preparation to shooting in the wind.**

Archery competition has gone through the double FITA Round and the Grand FITA Round etc. and many changes have taken place and currently the Olympic Round of modern times is the favourite. During the past double FITA Round, there was time for archers to observe the wind and adapt to it. However, in the present Olympic Round Team event, the archer shoots only 9 arrows and in the case of an individual contest the archer shoots 12 arrows, and the wind or rain becomes a decisive factor for

victory or defeat. Therefore, in extreme weather conditions most archers become worried about their performance during such a competition. Archers should change this concept of thought; this is because no matter how strong the wind blows the conditions are the same for all competitors. Most archers who worry about the wind usually fail in actual competition. If they had trained sufficiently in preparing for the wind they would be able to adapt to all changing conditions. Only adapting the archer’s training routine, for shooting in the wind, outside of competition will make the archer confident of shooting in the wind during a competition. An archer who fails during windy conditions should discuss this with their coach and together discover the cause for the failure and find a remedy for the problem. As the wind is natural and not artificially made it is difficult to anticipate the direction, power or angle of the wind in advance. Consequently only a thorough and composite training programme, incorporating these elements, will ensure the archer is fully prepared for all weather situations when they are encountered during competition.

1 2.3.1 Training for physical power.

*1 2.3.1a An exercise of repeatedly drawing the bow for a given set.*

During windy conditions the extending time can be longer than when shooting in calm weather conditions. Due to this, the main muscles that are used to draw the bow become tired quite rapidly and the balance and extending power etc. collapses and mistakes begin to be introduced. Therefore, a training routine for drawing the bow, including the extending time, should be conducted by slightly lengthening the time the bow is drawn to that when shooting in normal conditions. An exercise routine is outlined below:

Drawing	Recess	Drawing	Recess	Drawing	Recess	Drawing	Recess
7	2	7	2	7	2	7	2
Seconds	Seconds	Seconds	Seconds	Seconds	Seconds	Seconds	Seconds

The archer draws for 7 seconds, then returns to the state of set-up and repeats the process continuously. If the archer can practice this for 8 to 12 times their physical power is sufficient, this will become one set. For this exercise to be effective it will be necessary for this routing to be practiced 3 to 5 sets a week.

### 12.3.1b *The drawing of a bow and holding at full draw in excess of the time for a normal shot.*

The archer draws the bow, as far as they can, using their normal and proper stance, then holds at full draw for as long as the stance stays correct. The archer will do this three times for one set, and practice this routine for 3 to 5 sets 3 times per week. During these sessions the archer should maintain drawing the bow further than their normal arrow length but maintaining the balance of extending and the direction of power, these training sessions should be recorded on their normal training record card.

### 12.3.2 Training for the ability to aim at various points around the target face.

Since it is difficult to predict the direction and intensity of the wind, the archer should cultivate the ability to aim their sight at all points around the target face with confidence. Also the archer can move their sight in, or out, two, three or four turns, then “aim off” so that the arrow hits the centre of the target. In this way the archer receives training by sighting in many directions and they do not feel uneasy when the sight pin is not on the centre of the target face, this also trains the archer to keep an accurate direction of power. Even when it is not windy, sighting and aiming at different locations around the target face can be conducted.

### 12.3.3 Developing a sense of unity and direction of extending when “aiming off”.

At the time when sight aiming at various points around the target is being conducted, and even if the archers “group pattern” is in the centre of the target, the direction of extending should be in a direct line to the location of the “aimed off” position on the target face. There should be a sense of unity between the direction of extending and this aiming point.

### 12.3.4 The relationship between “aiming off” and the follow through.

When the wind is blowing it is imperative that the archer maintains the power line when extending. If the power line is not maintained: the bow arm shakes and the sense of direction of power can be lost. Consequently, the bow arm will collapse at the time of the release and the archer tends to lose control of the bow arm. This undesired movement can ruin the archers contest and the rhythm of competition is destroyed. The movement of the bow arm when the wind blows can be very lively. Archers should

maintain an accurate and continual sense of direction during the sessions of normal training.

### 12.3.5 The adaptation of changing the extending time.

In general, most archers tend to wait while the wind is blowing and when there is a lull in the wind shoot quickly. This is the most ideal method and well known by most archers. But the reason why it is important to adapt to the wind, and practice for this situation, is that the archer should be prepared for the worst conditions at all times. If an archer has only 10 seconds left on the clock and they still have one arrow to shoot, there will be only one chance to set up correctly and shoot it, there is no time for a second chance. Even if there is no wind the archer should practice so that the balance and direction of extending cannot be destroyed even if they intentionally lengthen their extending time. And conversely, the archer may well practice reducing the extending time during practice. During a team event, if archer number 1 or number 2 delays their shooting this reduces the time the archers following have to shoot their three arrows, and need to shoot quite quickly, which may be outside their normal shooting pattern. To prepare for this likelihood archers should conduct several training sessions of variable timing conditions in preparation for such occasions.

### 12.3.6 Maintaining the balance of extending.

During windy conditions the balance of extending varies quite a lot compared with shooting on calm days. The reason for this is the movement of the body caused by the wind lengthens the time of extending which in turn causes the archer to struggle to hold the sight on the given aiming point. During this time archers should not conduct the extending by artificial force i.e. using muscles that should not be used to conduct the extending (biceps), or by curling the fingers of the string hand to get the clicker to activate. Even if the time of extending lengthens, archers should produce a mastery of the holding balance so that a good shot is produced, if the holding balance is not maintained the shot can be ruined.

If an archer feels or observes a change in the relationship of the height of the bow shoulder and that of the arrow, along with any movement from the present position of the chest, they should seek help from their coach to remedy the situation before any unwanted problems develop.

### 1 2.3.7 Cultivating the ability to judge the wind characteristics.

When the wind is blowing during practice time, it is a common practice for archers to aim at the centre of the target and then move their sight to compensate for the deviation caused by the wind. This is not a good practice; at this time it would be better for the archer to “aim off” while shooting to get the arrow to hit the centre of the target. During a competition there is no time to practice sight aiming at other points around the target, the archer’s judgement must be accurate before shooting the arrow and the archer must have confidence the arrow will fly to the centre of the target. During normal practice times, the archer should be made aware of the importance to cultivate the ability to judge how much to “aim off” for differing wind strengths and conditions, and they should strive to cultivate this ability.

### 1 2.3.8 The observation and information gathering about wind conditions of a sports ground before taking part in a competition.

Many archers and coaches are interested to gain information about the wind direction and intensity in the sports ground where their next competition is to be held. A good indication, when at the competition ground, is to see any weather vanes or flags that may be fluttering in the vicinity, and to calculate their movement intensity and direction. Another indication of how the weather is affecting arrow flight is to watch other archers’ arrow flight during the practice time. A good coach will collect a lot of information from many people about the site before the competition begins. There are many differences, depending upon the season and/or layout of the sports ground. For some prestige competitions, such as the Olympic Games, extra stands or structures are assembled. You may know the ground, or even have competed there before, but these new structures will have an effect on wind conditions should it blow during the event. Sometimes the direction of the wind changes; this will be most noticeable during a seasonal change. With regard to a major competition, such as the Olympics, the coach should observe the wind and weather characteristics about one month before the competition and choose a similar site on which to practice. During this practice time it is necessary to layout the field in a direction so that the wind direction will be similar to the wind direction of the forthcoming major competition. Also during this practice, It is also necessary to change the direction of shooting occasionally so that the archer will be prepared should the wind change direction

during the competition. The reason for this is that on occasions the wind may change direction quite suddenly. It is wise to observe all items that can measure, or indicate, wind direction or conditions and choose which gives the most reliable information and refer to it.

### 1 2.3.9 What to practice during open practice time.

Determine the location of “aiming off” from the centre of the target classified by distance.

1. Measuring the intensity and direction of the wind classified by time.
2. Observe the arrow flight of other archers and consider any anomalies.
3. Check the operation of any weather vane or flags in the vicinity.
4. Watch other archers to see if they shake or shiver as a result of the wind.
5. Consult with fellow team members and coach about the intensity of the wind.
6. Make comparisons between the weather conditions at the auxiliary practice ground and sports competition ground.
7. Make an observation of the wind conditions of the competition field that will be used for the finals, theses targets could be placed in the centre, or to the side, of the field.

The archer should observe and react to the wind rather than concentrating on arrow flight at the time of open practice.

### 1 2.3.10 Reference to other archers’ arrow flight at a competition.

When the wind is blowing it is good practice to refer to other archers’ arrow flight. This can be very useful especially when the weather vane changes direction or the fluttering of the flags changes intensity. It can also be very useful during a team event, the archer who shoots first should decide, after considering this information, how far off centre they should aim so that the arrow lands in the centre of the target. The other team members then watching this arrow flight and seeing where it landed in the target can make calculations to benefit themselves when they shoot. If an archer stands on the shooting line then tries to calculate where to aim, their mind will introduce many conflicts and their judgement ability becomes unclear. But conversely, if the archer has already calculated where they should aim before they come to the shooting

line and the wind changes in intensity or direction, it will not be too difficult to calculate a new aiming location.

#### 12.3.11 Advice from a fellow archer or the team coach during practice times.

During normal practice times for team competition, archers should not give advice to each other about where to aim, even the coach should not give this advice. This is because each archer's equipment and power of shot will be different and therefore aiming points will differ. However, other archers or team members can pass on valuable information i.e. the actual flight of their arrows. If an archer watches the arrow flight of their colleagues, calculations can be made to assist their decision on where they, themselves, should aim.

This will be beneficial when taking part in team events during competitions. This practice will develop a sense of unity in aiming even though the thoughts are different, and it will reduce the conflict of judgement and the rhythm of competition will not be destroyed.

#### 12.3.12 Imagery training.

When the wind is blowing an arrow does not fly in a straight line to the target, so an archer becomes considerably uneasy psychologically. Therefore it is good to practice imagery training by picturing in ones mind the view of an arrow as it flies through the wind but still hits the centre of the target.

#### 12.3.13 Adaptation to a momentary change in the direction of the wind.

If the archery training field is large enough and if it is safe to do so, a good training aid is to have a target at each end of the field. The archer shoots their arrows at one target then collects them; they turn round and shoot their arrows back down the range to the other target. This will have the effect of shooting in constantly changing wind direction and conditions.

#### 12.3.14 Choosing the right clothing for shooting in the wind.

When choosing clothing for shooting in the wind, it is important that no part of the clothing, i.e. the collar or sleeves etc., hinders or affects the path of the string. Sometimes the sound of the sleeves fluttering can have an adverse effect on the archer's concentration and cause degradation in the quality of the shot. The archer should prepare for the wind and choose a uniform for competi-

tion that has been thoroughly tested in windy conditions in advance of the competition.

#### 12.3.15 Selecting and tuning the equipment.

In windy conditions it is possible the position of sight aiming and the selection of accessories will have an effect on the tuning of the equipment. The weight of the arrow point, the fletching type and size, the form of the arrow etc. are directly linked to good arrow flight and the outcome of the archer's performance. Also, the weight of the bow and the selection of the stabiliser system have a direct bearing when shooting in the wind and the archer may need to consider the choice selected for any particular occasion. Especially, consideration should be given to the compatibility and tuning of the plunger button, and the direction of the wind, should be thoroughly checked to ensure an efficient and smooth operation.

#### 12.3.16 Preparation, straightening out, and practice prior to, and after, a competition during windy conditions.

When the wind blows the archer's attention to the stance becomes distracted. Therefore the archer should practice and concentrate on their stance shortly before the competition begins. Also, after the competition is over the archer should practice at a short distance the art of producing a good stance. This is because they should be prepared for the next competition. There are many situations where the body forgets a "sense" very easily and comes accustomed to a new and sometimes incorrect body position. There are many and various methods of rectifying this situation and may seem to be complicated, but archers should not think of them as being complicated. With good training the archer can construct a habitual and reproducible action that is quickly achievable if the time lapse between producing the errors and formulating the correction is not too long.

During a competition many actions are made sub-consciously. Many years ago we saw the case of an archer, Jin Ho Kim (currently a professor at the College of Korean Physical Education) where although she was "aiming off" we could observe that when the direction of the wind changed her body movement and state of holding changed. This was possible because of her strict training routine, in all weather conditions. The most important point is for the archer to practice in the wind, come to respect it and not to be afraid of it, and to create a sense of conviction that the wind will always help you.





FITA  
Coach's  
Manual

**STANDARD Bow**

Module

Intermediate  
Level



# FITA Coaching Manual

## Intermediate Level

### Module

### STANDARD BOW

<i>Coaches notes for the Standard Bow</i> _____	2
<i>FITA Standard Rules</i> _____	2
<i>FITA Standard Bow Equipment</i> _____	3
<i>String</i> _____	3
<i>Finger protection</i> _____	3
<i>Bow length</i> _____	3
<i>Stabilization</i> _____	4
<i>Arrow Rest</i> _____	4
<i>Brace Height</i> _____	5
<i>Bow sight</i> _____	5
<i>Draw check indicator</i> _____	5
<i>Audible Draw Length Check Indicator</i> _____	7
<i>When to introduce shooting with clicker?</i> _____	7
<i>Tuning of a standard bow</i> _____	10

#### Coaches notes for the standard bow

The Standard Bow Division was introduced by FITA to allow Member Associations, whatever their Country's level of technical and economical development, to engage in the sport of Archery at low cost with equipment that was relatively simple.

The Standard Bow, as defined for competition by FITA Rules, is the bow that is acquired by the majority of archers as their first bow and as such should not be overlooked in the development of the archer's fundamental form/style.

Because the Standard Bow is a basic bow without any extraneous attachments archers can concentrate on the Coach's development strategy without the added problems of doubt associated with complicated bow attachments.

Bow weight should be carefully considered and kept to a weight that is conducive with the archer's ability to correctly control the bow. A too heavy draw weight will hinder the archer's ability to learn the correct basics of form.

Limitations of these bows should be realized and archers using them should be encouraged to shoot distances that are appropriate to their ability. Shorter distances will allow archers, using these bows, to concentrate on acquiring the required skill level without the added stress of not hitting the target.

Tuning of this equipment is limited by the attachments allowed for competition and should be kept to the fundamentals so as not to confuse the archer. The only tuning that is required are basic adjustments to the nocking point, centre shot and brace height. Also ensure arrows are of the correct spine (see descriptions further below).

A Standard Bow should not be up-graded with more complicated attachments until the archer's basic form has been established and is consistent. To avoid confusion the Coach should introduce attachments one at a time rather than fitting two or three new items together.

As the majority of archers begin their archery development with the Standard Bow they should be coached using the available information in the Entry Level Coaches Manual. The information contained in this manual will enable the coach to establish the archer's fundamentals of correct shooting form.

Coaching an archer with this equipment will enable the archer to develop the basic skill required to acquire a higher level of competence without concerns about equipment problems.

Coaches should encourage archers to practice with a Standard Bow until their form has developed to the stage where their basic style has become consistent and repeatable.

Introduction to competition should be promoted using this equipment, as there are divisions in tournaments and awards available that are commensurate with the individual's ability.

By the time an archer reaches an intermediate level a Standard Bow will have outlived its usefulness for the archer's future development and it would be time to consider investing in up-graded equipment.

#### FITA Standard Rules

The bow will be of a simple design, either a take-apart type (with wooden or metal riser, no shoot-through type) or of one-piece construction. In both types of bow the limbs will be of wooden and/or fibreglass construction.

- The **bowstring** material may not be of a higher specification than Dacron.

- The **arrow rest** will be of a simple flexible or rigid design and it will be non-adjustable. A simple nonadjustable pressure point may be used but will be placed no further back than 2 cm from the throat (pivot point) of the handle.
- One simple **draw check indicator**, audible or visual, may be used.
- The **bow sight** will be of simple construction and must not include any vertical rack or pinion or screw type of micrometer adjustment. Lateral (windage) adjustment may be made by use of a screw type adjuster. The sight and any attachment to which it is fixed must comply with the Note below. The sight point may not be a fibre optic type.
- Any **stabilization** used must comply with the Note below. Torque flight compensators (TFCs) must not be used.
- **Arrows** must not exceed a specification of XX75 or equivalent, and will be of an equivalent price range and performance. The nocks will be of simple construction, either conical or insert fitting. The points will be conical or ogival in shape. The vanes will be of soft plastic material or of natural feathers.
- **Finger protection** must not include any form of stiffening or locating platform or similar or any device to help hold, draw and release the string.
- **Field glasses**, telescopes or any other visual aid must not be used for spotting arrows. Shooting spectacles must not be used.
- **Accessories** that are permitted include braces (arm guard), dress shield, bow sling, belt or ground quiver and tassel. Foot markers may not protrude more than 1 cm from the ground.

**NOTE:** The unstrung bow complete with permitted accessories (stabilization when extended in any direction) must be able to pass through a hole or ring of 12.2 cm inside diameter  $\pm 0.5$  mm.

The FITA STANDARD ROUND consists of 72 arrows shot in ends of 3 arrows at the following distances: –

50 meters–36 arrows

30 meters–36 arrows

Target Face to be a ten-zone 122 cm at both distances.

## FITA Standard Bow Equipment String

The string must be made from Dacron. This material is not stable in as much as it stretches during use therefore:-

- The bow should be strung and left to stand until the string stretches. The brace height will vary until the string stabilizes.
- Having the bow resting in full sunlight will stretch the string a remarkable amount and can change the whole bow setup and its efficiency.

## Finger protection

Archers should be encouraged to use some form of finger protection. Constant drawing of the bow without finger protection will cause problems with fingers that will inhibit the release process.

For Target Archery “finger tabs” are preferable to “shooting gloves”.

Finger tabs should not extend beyond the fingertips when the fingers are placed around the string.



## Bow length

The length of a bow is measured from the string nock on the top limb around the back of the bow to the string nock on the bottom limb. The length of the bow determines, to a large degree, the string angle at the drawing fingers which, if too sharp, produces difficult releases and pinched fingers or arrows.

It also determines the energy stored at a certain draw length and contributes to the performance of the bow.

Suggested bow length for Target Recurve Bows range from 62 inches to 70 inches.

Draw length	Bow length
up to 25 inches	– 62 inches

25 to 26 inches	–	64 inches
26 to 27 inches	–	66 inches
27 to 28 inches	–	68 inches
over 28 inches	–	70 inches

If an archer with a long draw length were to use a short bow, apart from the damage that could be done to the bow, the string angle created at full draw would cause pinched fingers making a clean release extremely difficult. On the other hand a bow that is too long for an archer most probably will not reach its full efficiency, launching the arrows too slowly resulting in a rather high trajectory line.

### Stabilization

Due to restrictions on stabilization (according to FITA rules for the standard bow) it should be limited to a small weight low on the bow to allow the bow to tip forward rather than backward on release.

Extra stabilizers will add weight to the bow to enable archers to become accustomed to the extra weight when they update their equipment. A heavier bow is easier to be held steady whilst aiming, it is also more stable on release as it helps to reduce the effect of the string reflex on the bow; furthermore it is not so much affected in windy conditions. In using stabilizers for shooting in the standard bow division one must keep in mind that the unbraced bow with its equipment including stabilization has to fit through a hole of 12.2 cm diameter.

### Arrow rest

As the arrow rest and pressure point are not adjustable, ensure that: -

- If a simple pressure point is used the arrow sits in the centre of the pressure point. This can be achieved by positioning the arrow rest correctly in a vertical direction, see figure 1.

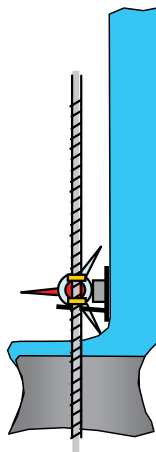

Figure 1

- The pressure point allows the arrow to be pointed approximately half an arrow width outside the string when the string is aligned down the centre of the bow.

Depending what kind of riser is used the arrow rest may need an underlying cushion to achieve the necessary off-centre position of the arrow. The off-centre position has to compensate for the effect of the finger release with its string reflex which will show up with novices more who tend to have a more explosive release than with advanced archers who should be able to release smoothly.

To get a proper off-centre position do the following: at first you have to check if the bow is truly aligned in itself. With a ruler or a bow square you measure the width of the upper and lower bow limb where it meets the limb pocket. Divide by 2 and make two marks 1-2 mm on either side of that measured middle mark on either bow limb, see figure 2.

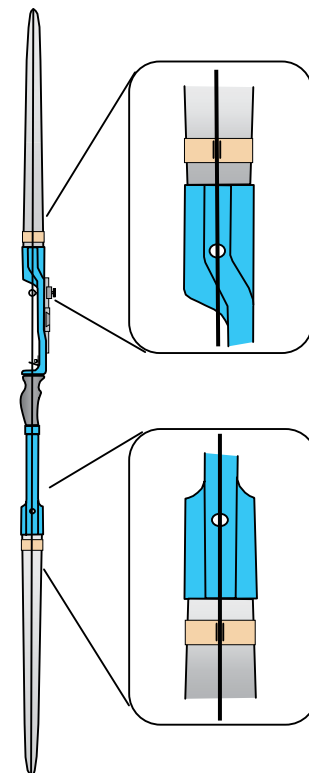

Figure 2

Now, fix the bow in a vertical position and load with an arrow; stand firmly about one meter back from the string, close one eye and see the string lying in between these two marks on either limb. Now, without any movement, focus on the point of the arrow and see where it is located in relation to the string. With right-handed archers the right edge of the point should slightly touch the left



edge of the string; in other words: the point of the arrow should completely be on the left side of the string (vice versa for left-handed archers), see figure 3.

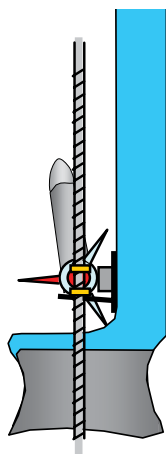

Figure 3

Most simple arrow rests that include some form of pressure point and are unable to be adjusted in any way, are able to be fitted to comply with the above requirements.

These arrow rests are made out of plastic material thus the pressure point will wear off and get thinner and thinner thus reducing the off-centre position of the arrow with the time. Also the part of the arrow rest where the arrow actually rests on will get a groove thus imitating a nocking point that is too high after a few months of intense shooting. This especially happens when the archer is using the heavier aluminium arrows which are the only ones allowed with the standard bow.

### Brace height

The Brace Height of the bow is the distance, measured at right angles, between the string and the grip pivot point (the deepest part of the grip) of the bow.

Altering the length of the string will vary the brace height of the bow. Lengthening the string will lower the brace height and vice versa shortening the string will increase the brace height.

General Bow manufacturer's recommendations for brace height are: -

Bow length	Brace height
66 inch	– 8.25 to 8.75 inches
68 inch	– 8.5 to 9.25 inches
70 inch	– 8.75 to 9.5 inches

The best brace height for each individual bow will be found somewhere between the recommended figures.

At some point between the recommended tolerances the bow will sound quieter and the arrow groups will be tighter, this will be found to be the best brace height for the bow. To find this point the brace height should be altered by varying the string length, this can be achieved to some degree by twisting or untwisting the string.

The brace height influences the initial horizontal bending of the arrow during the early stages of flight, as it changes its dynamic spine of the arrow (see below under arrows).

### Bow sights

The use of a simple Bow Sight will enable the archer to get consistent aiming geometry and thus achieve a tighter group of arrows on the target face. A short sight extension may be used keeping in mind that it must fit through the afore-mentioned hole when mounted.

The quadrilateral method of aiming is recommended for use with a Bow Sight. Concentration on the Bow Sight alone will not give the archer the consistency they require, the Coach should emphasize the importance of: -

- **A consistent facial reference as the back sight:** i.e. the alignment of the front and rear of the arrow in respect to the target to avoid vertical errors. An important factor is the tip of the nose and its point of contact with the string. The side of the nose does not give such a correct aiming geometry, as an archer cannot always be sure that the same part (referring to the up and down position) of the string touches their nose; again, highs and lows will occur.
- **String alignment:** i.e. alignment of the string with the same position on the bow for each arrow to avoid horizontal errors.

Right to left head movement will cause variation to string alignment.

### Draw length check indicator

A Draw length check indicator is a device fitted to the bow to indicate to the archer that all arrows are drawn to a predetermined length.

The introduction of a draw length check indicator too early in the archer's development will inhibit progress. A draw check indicator should not be placed on the bow until the archer's style has developed to the stage where the archer is able to consistently increase back tension during and after the sighting phase of the shooting sequence.

With the draw length check indicator the archer gets the guarantee that the arrows have always been drawn back the same amount. According to the physical laws shown in a force-draw curve the same amount of energy is transferred to the arrow at the point of release with each shot, see figure 4.

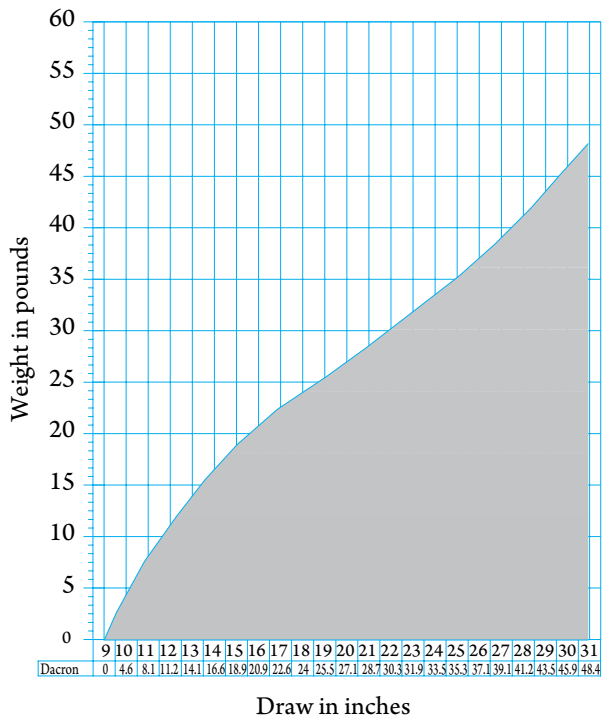

Figure 4

The shaded area shows the amount of energy stored by the bow.

Due to the law of gravity the trajectory line of the arrow flight will consequently be the same with each shot. This is particularly important when shooting longer distances and is a pre-requisite to get high scores, see figure 5.

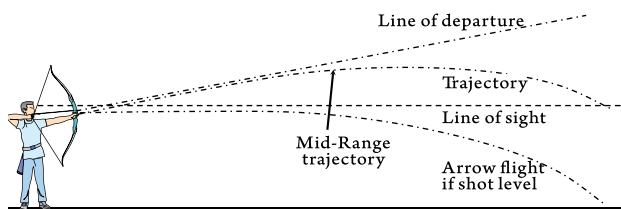

Figure 5

**Draw Check Indicator**  
**Visual Draw Check Indicator**

A Visual Draw Check Indicator is a small mirror (approximately 0.75 x 0.5 inches – 20 mm x 12 mm) which is mounted in the bow window, as high as possible and at an angle of approximately 45°, to enable the archer to see

the tip of the arrow at full draw, see figure 6. The mirror should not be mounted to inhibit the archer’s ability to see the sight pin.



Figure 6

The archer’s draw length will be consistent if the tip of each arrow can be seen to be drawn to the same reference point on the bow.

The archer’s draw length will consistently be the same with each arrow if the tip of the arrow point or the front cut end of the arrow as reference points is seen in the same area in the mirror; this may be its lower or upper corner or wherever is convenient for the individual archer. When using such an indicator the archer must learn to come to full draw under control with the mirror and only then focus on aiming. This is again best practiced, when drawing back with the eyes closed, when at dull draw open the eyes and check where the arrow or its reference point is situated in the mirror.

It is strongly recommended not to switch the focus between mirror and target as firstly this destroys concentration on a proper shot performance and secondly tires the archer’s eyes especially when they are focusing on the target butt (with the sight pin seen blurred) and not on the sight pin (with the target face seen blurred) for their aiming. Unfortunately, shooting with a mirror gives the archer one more visible point for the eyes to focus on; this can interfere with the aiming process in a very uncomfortable way so that the archer is disturbed in achieving a smooth and ongoing shot sequence.

To prevent back tension from coming to a stop at full draw the archers should learn to slow down with their backward movement of the string when the front cut end of the arrow can be seen at the lower rim of the mirror and then focus on aiming whilst continuing with increasing back tension. This prevents the archer from creating a static form of release.

The disadvantages of this type of indicator are:

- The archer should concentrate visually on the target at full draw and not on the draw check indicator. Eye muscles will tire, as the use of this indicator will require more eye movement i.e. the eye has enough on which to focus with string alignment, sight and target.
- Increase in back tension may stop when visual reference indicates that the arrow point has reached the reference point.

This type of Draw Check Indicator is best suited to being used as a training aid to help the archer to determine a consistent draw length.

### ***Audible Draw Length Check Indicator***

An Audible Draw Length Check Indicator, known as a clicker, is a metal strip, approximately  $\frac{1}{4}$  inch (6 mm) wide, attached to the bow window in front of the arrow rest in such a manner as to allow the arrow to be loaded underneath the clicker while being nocked on the string.

At full draw, back tension is increased until an audible “click” is heard as the clicker hits the bow riser when the arrow has been drawn from underneath it. The “click” indicates that the arrow has been drawn to the correct length i.e. the correct draw length has been established. Care should be taken not to use the audible clicker as a release “trigger” if the sighting process has not been completed.

Care should also be taken in mounting the clicker on the bow to ensure: -

- That there is no downward pressure exerted to the tip of the arrow as it is drawn from under the clicker.

The clicker should ideally be mounted as near as vertical as possible to avoid extra pressure to the arrow tip from the front, see figure 7.

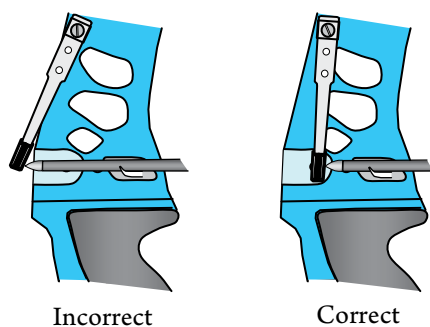

Figure 7

Its tension should be strong enough to create a well audible “click” but not so strong as to press the arrow into the pressure point thus reducing the off-centre position.

Also the side pressure exerted by the clicker should not be excessive, but is strong enough to enable an audible indication to be heard at the desired draw length.

This style of Draw Check Indicator ensures that back tension is being increased at the time of release.

The advantage of a clicker is that the optical system of the body gets a certain relief through an audible command. A critical point in shooting with a clicker is to hold the sight pin into the centre of the target face and having everything else ready at the time when it clicks.

How to shoot with a clicker: for the last few centimetres before the archer comes to full draw the backward movement of the release hand should slow down, at the same time go on with increasing back tension and finding the reference points of the face and correct aiming procedure, finally immediately release the string when the “click” is heard. The archer should release the clicker through a continuous and smooth coming to full draw, and the clicker should then be the command for the archer to immediately release.

When archers start using a clicker they should first have mastered their form so that they have a constant draw length. At first they should shoot at a butt from 5 metres, and get used to the sound of the clicker and be able to produce a controlled release. With a coach close at hand they could try shooting with the eyes closed and concentrate on:

- a) Constant timing,
- b) The continuous increase of back tension, and
- c) The continuous movement of the release hand after the release (dynamic release).

Special care should be taken that the archer does not start “sawing” underneath the clicker (forward-backward movement of the arrow point) or “freezing” (no more movement at all) or to stop-and-go, i.e. coming to a certain point – then focusing on aiming – then start drawing again for the final millimetre (s) to release the clicker.

### ***When to introduce shooting with a clicker?***

Recommendations differ; some say as early as possible in archery life, others say only after the archer has established a good form. If an archer has decided to go on with Recurve equipment they should be encouraged to use a clicker as early as possible to get used to it, to see it as

a natural assistance for a smooth release, and a help for producing the same draw length, thus poundage. As draw check indicator the clicker is always more recommendable than the mirror as with the clicker there is one visible point less to focus on and the flow of the shooting process is easier to achieve.

It can take quite a while until an archer is used to getting everything right when the clicker activates. Tests have shown that the shorter the reaction time after the click the smoother the release hand goes back as it comes as a natural consequence of the release. To improve the reaction time it is a good idea to do additional training in other sports like table tennis or badminton.

The use of a clicker may be of special benefit to archers who are “snap shooters”. They are in fact forced to go on with their backward movement of the release hand and come to a solid full draw otherwise they do not get the click.

To get the proper clicker position an archer should refer to their correct draw length, and of course, all arrows must be the same length. Have the archer draw an arrow and mark where the point stops in relation to the sight window at a full and comfortable draw; this procedure should be done firstly with the eyes closed and secondly be repeated a few times to be sure of the correct position. Be aware that if an archer has not yet practiced very often and the shoulder girdle is not yet fully adapted to the sportive effort, or when coaching juniors who are not yet fully developed, the clicker position may vary as a result of the development of the shoulder and upper chest area.

If the clicker has not been positioned correctly the archer may establish bad habits:

- a) If the clicker is too close to the archer they may
  - Lean backwards.
  - Develop tension in the drawing fingers.
  - Switch from a low grip to a high grip intermittently to get extra length.
  - Rotate the elbow of the bow arm into the path of the string.
  - Not come through the clicker at all.
- b) If the clicker is too far away from the archer they
  - May establish a high bow shoulder.
  - May bring the head towards the string.
  - Certainly will not use back tension effectively.

## Arrows

### *How to find the appropriate draw and arrow length*

According to AMO (American Manufacturers Organization) the “standard” draw length measurement is determined as the distance from the string (or the bottom of the nock slot) to the pivot point (the most inner point) of the bow grip at full draw plus (to compensate for an average design of the riser) 1 3/4”.

To find out an archer’s individual draw length either a “measuring” bow with a very light draw weight (about 5 lbs) or an elastic string may be used. Have the archer pull back the string together with a full length arrow so that the archer comfortably reaches full draw as practiced before. Stand beside the bow and mark the arrow at the position of the front edge of the riser. This represents the individual archer’s draw length. When the archer’s arrows are to be cut, the mirror or clicker position respectively as well as the length of the point have to be kept in mind. Thus, it is a good idea to have a second mark on the “measuring” arrow to show you the proper clicker position or the best position for the mirror which should already be mounted.

To get good and reliable readings it is recommended to have the archer closing their eyes and repeat the procedure a few times.

It is imperative that all arrows are the same length to maintain a constant draw length when used in conjunction with a clicker. Different lengths will also cause variations in weight, which will cause differing impact points on the target; hence larger groups on the target.

Arrows should be matched to the bow by reference to an appropriate “Shaft Size Selection Chart”. These charts match the archer’s bow weight and draw length to enable the correct arrow, for this combination, to be selected.

### *What does mean XX75?*

The XX75 is a cylindrical aluminium tube of special alloy and comes in different sizes, which concern the outside diameter and wall thickness. The back end of the tube shows a reduced diameter and a nock taper where a nock of simple design can be glued on. It is also possible to get arrows in different colours and different spines.

Spine is a measure for the stiffness of an arrow. As we have the string lying in the first finger crease when drawing the bow and at full draw the string “rolls”, more or less, over the finger tips at release. This makes the string forward movement, not in a straight line, but in a line similar to a sine wave. As the nock follows this movement it makes the arrow bend similar to the movement of a snake.



This flexing happens throughout the arrow flight until it hits the butt. For a proper arrow flight we need to have an appropriate flexing (or the correct stiffness) of the arrow. See figure 8.

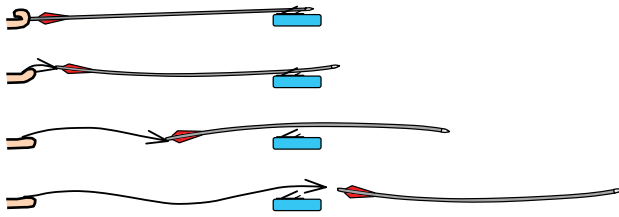

Figure 8

*The bending of the arrow during the initial stages of its travel.*

To find the proper spine for a certain bow setup there are many charts or computer programs on the market that will help make the correct decision on which arrow spine to select.

When measuring arrow spine rating an arrow of 29 inches is used, this is pivoted a half an inch in from each end and a weight of 880 grams (1.94 lbs.) is hung in the middle. A dial gauge measures the movement from the home position of the arrow to the position now reached with the weight suspended. This measurement is calculated in 1,000<sup>ths</sup> of an inch to give the static spine rating of this particular arrow. I.e. an arrow that deflects a ½ inch (0.5 of an inch) will have a static spine rating of 500, and an arrow that deflects ¾ inch (0.75 of an inch) will have a static spine rating of 750.

Be aware that some of the smaller diameter arrow shafts may be measured at 26 inches instead of 28 inches. This will depend on what type of arrows are purchased and what specification.

On some arrows you may see number like '1816' or '2115' etcetera, this number is part of the spine identification system and means the '1816' arrow has an outer diameter of 18/64<sup>ths</sup> of an inch and 0.016 of an inch wall thickness, or the '2115' arrow has an outer diameter of 21/64<sup>ths</sup> of an inch and 0.015 of an inch wall thickness. We should keep one point in mind: the arrow length in the selection chart does not include the length of the point but is the distance from the bottom of the nock to the front cut end of the arrow.

It is interesting to note that increasing the draw length by one inch has approximately the same effect as increasing bow weight by two to three pounds; further calculations can easily be made with the, afore mentioned, computer programs without buying new equipment.

Many Arrow Selection Chart were formulated for modern Recurve bows, standard 7% F.O.C (front of cen-

tre) points for aluminium shafts, Fast Flight string and finger release. For the slightly reduced efficiency of a Dacron string which we have to use in the standard bow division we may subtract 3-5 lbs from the actual draw weight of the bow to select the correct arrow.

If we have a choice between two different arrow spines we should take a few facts into account: Normally, we recommend to opt for the stiffer one, in particular when we have to deal with youngsters who are physically not yet fully grown or with beginners from whom we expect an increase of their draw weight, due to their longer draw length as their skill improves; it is much easier to compensate for an over-spined arrow than for an under-spined arrow. In such cases it should be kept in mind that the wall thickness has a bearing on the weight of an arrow thus a heavy arrow may result in requiring a higher trajectory line than a lighter arrow for the same distance to be shot. For indoor shooting that factor might not be of such importance but shooting a distance of 50 metres the decision for an arrow should be influenced by that knowledge.

For competition all arrows should be of the same type fitted with identical fletches and nocks. Arrows must be marked, on the shaft, with the archers name or initials.

We have already learnt what the spine of an arrow means; this has to do with the static spine which is just a measure for the arrow's ability to bend. The dynamic spine involves additional factors that occur during the release and flight of the arrow:

- The length of the arrow: the longer the arrow the weaker it reacts with the same poundage.
- The brace height:
  - with a brace height being on the upper limit the limbs of the bow are more "compressed"; hence the bow is stronger. Meanwhile the arrow leaves the string at an earlier stage; reducing the power stroke.
  - with a lower brace height the limbs of the bow are less "compressed"; hence the bow is lighter. Meanwhile the arrow is driven by the string for a little longer distance until it leaves it; increasing the power stroke.

This changes the dynamic spine in so far that with the lower brace height the arrow generally behaves as if it was stiffer due to the decreased bow weight which means that a group of properly tuned arrows will have a tendency to hit more to the left side of the target centre and the bare shaft (see right under basic tuning) hits more to the left of fletched arrows for right-handed archers (and right vice versa for left handed archers).

- The point weight: the higher the point weight the more the FOC (front of centre = balancing point) moves towards the front cut end of the arrow, meaning that the arrow reacts weaker.
- The fletching: the heavier the fletching the more the FOC moves towards the back cut end of the arrow which results in a stiffer arrow reaction.
- The fit of the nock on the nocking point (tight or loose): if the arrow has a rather tight fit on the string it will not come off the string cleanly and to a certain degree will show a stiffer reaction. But changing the thickness of a nock point is no way to correct for an incorrect spine.

### Tuning of a standard bow

Although there are several restrictions concerning permitted accessories for shooting with a standard bow according to FITA rules we are not short of using basic tuning methods to get as high scores as possible.

The basic tuning procedure for shooting a standard bow with aluminium arrows is the bare shaft test.

Normally, we shoot with fletched arrows; the fletching being useful and necessary for stabilizing the arrow during its flight as soon as possible after it leaves the bow. The bare shaft test shows possible deviations of the desired arrow flight that would be compensated by the fletching. This is not just bad performance of the arrow; it slows down arrow velocity, thus creating a higher trajectory line, and in the end will create wider groupings of arrows at a specific distance.

Of primary importance is the location of the nock point. A suggested starting point is to have the nocking point set so that the bottom of the arrow is approximately 5 millimetres above square, taking the vertical line of the string with the bracing height gauge/bow square extension resting lightly on the arrow rest. Fix a clamp-on nock locator in that position, see figure 9.

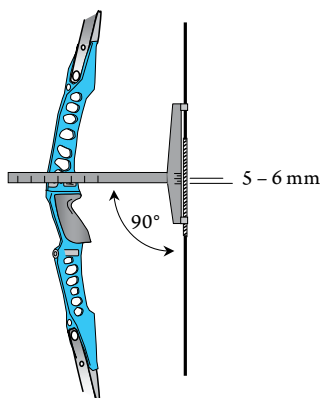

Figure 9

The first step is to find the correct nocking point for the individual archer: have the archer shoot a few fletched arrows on a distance not more than 18 meters. Then shoot at least 2 unfletched arrows (bare shafts) aiming always to the same point. If the unfletched arrows hit higher than the fletched ones the nock point is too low and the archer should move the nock locator slightly up approximately a half millimetre, then try again, and continue until the correct result is achieved. If the unfletched arrows hit lower than the fletched arrows the nock point is too high and the nock locator should be moved down a half millimetre then try again, and continue until the correct result is achieved, see figure 10.

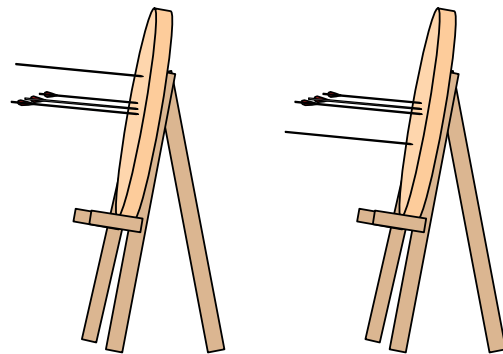

Figure 10

The worst situation is to have a nock point too low as the arrow will fowl the arrow rest and get deflected upward when leaving the bow, thus creating a worm-like flight with up and down movements called Porpoising. To confirm that the nocking point is not too low, the bare shaft may hit about one inch lower than the group of fletched arrows at short distance. Also it should be remembered that due to the stretching of a Dacron string during a practice day or a competition the brace height will decrease, this will affect the relationship of the nocking point and arrow rest.

The next step in this test is to check for left and right impacts of the bare shaft in relation to the group of fletched arrows. We use again a distance of not more than 18 m for this test. An over-spined arrow will have a bare shaft impact too much to the left of the fletched ones (we call that “too stiff” for a right handed archer) see figure 11, whereas the under-spined arrow will hit more to the right of them this is “too weak” for a right handed archer, see figure 12. For left-handed archers the opposite direction is applicable. As a rule of thumb we recommend that the gap between the group of fletched arrows and the bare shafts is not more than 3 – 4 inches (7.5 to 10 cm) on 15 – 18 m distance.

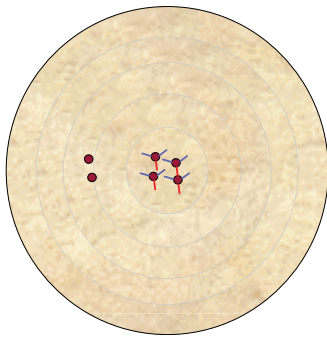

Figure 11

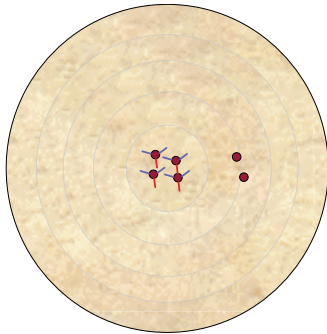

Figure 12

The overall recommendation is that the bare shaft on 18 m distance should be on a butt with the 40×40 target face within a line from the ten to the eight at 8 o'clock (for left-handed archers from the ten to the eight at 4 o'clock).

If the test gives us a **slightly** over-spined (too stiff) arrow we do have several means to compensate for this without buying a different weaker set of arrows; we may use:

- A heavier point weight.
- Lighter fletching (e.g. shorter vanes).
- Longer arrows (the clicker position should be kept in mind).
- Increase poundage.
- Increase the brace height.
- Using a string with fewer strands.

If possible, move the pressure point of the arrow rest (for right-handed archers: more to the right), pending on the amount the sight window had been cut out which is more with metal risers (thus better adjustable with metal risers).

Advice in the opposite direction is valid for **slightly** under-spined arrows. The word "slightly" is in bold letters as an arrow which is definitely one category over or under-spined cannot be compensated for with the changes mentioned above. With such arrows the archer would get fish-tailing (right-left movement) during the arrow flight.

When the correct arrow and bow setup has been found with the bare shaft test the archer may go on with a more

finely tuning procedure which would be the variable distance or walk-back method.

Set up a target and pin on a piece of card about 7.5 cm square 20 cm from the top. Then place marks on the ground from 20 to 50 metres in 5 metre increments from the target. If necessary a second target can be placed in front of and leaning on the target which is on the stand. This will allow the archer to shoot from a greater distance producing a more accurate result. Remember to secure the second target.

The archer should set the sight on their 20 metre sight mark; **the sight should not be moved again during this tuning procedure.** Stand on the 20 metre position marked out on the ground and shoot three arrows at the piece of card on the target, move back to the 25 metre position and shoot another three arrows, move back to the 30 metre position and shoot another three arrows. The arrows may be retrieved as required, but before they are removed from the target mark the centre of each group of three arrows with a target pin, small disc of card or similar.

Continue moving back and shooting until the line of arrows/marks reach the bottom of the target, this will normally be after 20 to 25 metres i.e. a shooting distance of 40 to 45 metres, which will be dependant on the efficiency of the bow.

After the whole process, connect the lines of target pins or small discs, which mark the centre of each group of arrows, with one single line from top to bottom. Now, there might be different pictures on the target face as shown below which give us some important information, see picture 13.

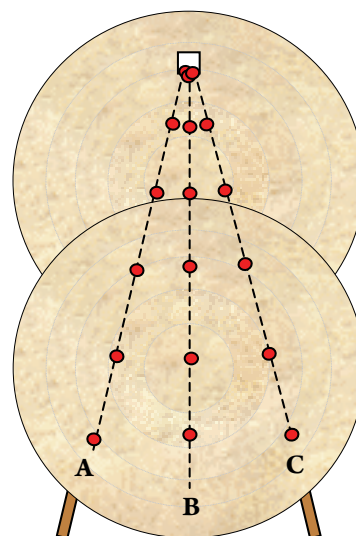

Figure 13

**Interpretation of the readings:**

**B:** If the arrow line follows a central line this is the ideal condition

**A:** The off-centre position is to be corrected; for right-handed archers the pressure point of the arrow rest should be moved to the right, or use heavier piles in the arrows. If the line cannot be corrected it may be necessary to get a weaker set of arrows.

**C:** The off-centre position is to be corrected; for right-handed archers the pressure point of the arrow rest should be moved to the left, or use lighter piles in the arrows. If the line cannot be corrected it may be necessary to get a stiffer set of arrows.

For left handed archers the movement would be vice versa.

After all that the archer should not hesitate to do a kind of “ultra-fine” tuning with their bow setup. In these

instances, this has to do with trial and error. They may try a change of the brace height within the well-known limits, different fletching, heavier (for example with little pieces of lead melted inside the point shaft) or lighter point weight, longer or shorter arrows, heavier stabilizer, and so on. They should never forget about one important rule: only change one thing at a time! Otherwise, they will get a mixture of information with no benefit at all. Also keep in mind, a change of the bow setup may not show its effect after three arrows but it may take longer, possibly only after a full days practice. It is important to make notes on what has been changed; the notes should be recorded to get an overview of what has been done. From the knowledge we have so far experimentation can follow a completely logical route.

Even within the rather limited facilities in the standard bow division a lot of changes/adjustments are possible.





FITA  
Coach's  
Manual

**TRAINING PLAN**

Module

Intermediate  
Level



# FITA Coaching Manual

## Intermediate Level

Module

### TRAINING PLAN

#### Yearly Plan for Adults in Outdoor Target Discipline Training distribution shown in percentage of time allocated

	Oct	Nov	Dec	Jan	Feb	Mar	Apr	May	June	July	Aug	Sept	Objectives
General & specific physical preparation	45	30	30	20	5	5	5	5	5	5	0	0	1A et 1B
Psychological preparation		5	5	10	5	5	5	10	10	10	15	10	2
Shooting form	55	65	65	50	20	10	5						3
Automation of the coordination	0			20	40	45	45	40	25	20	10	10	4
Competition management	0				30	35	40	45	60	65	75	80	5
	100	100	100	100	100	100	100	100	100	100	100	100	

#### Yearly Plan for Adults in Outdoor Target Discipline

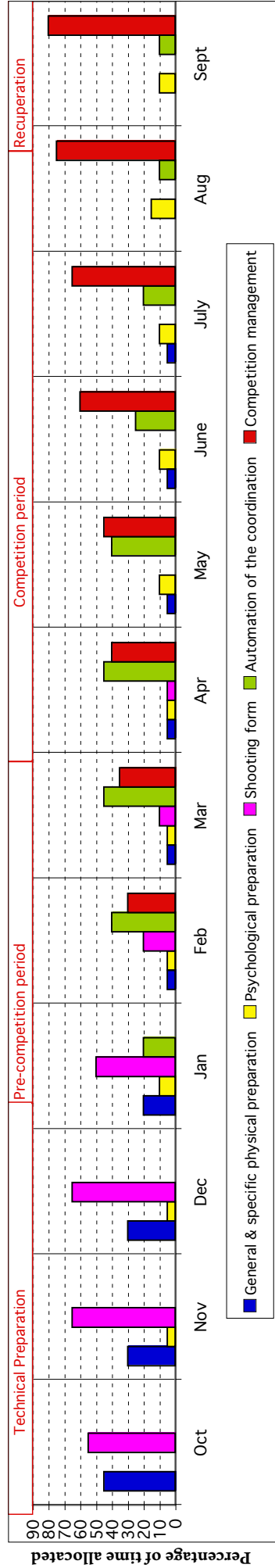

#### Objectives

1A	Important overall physical preparation at the beginning of the season and during the recuperation. Maintain a good fitness during the season.
1B	Important overall physical preparation at the beginning of the season and a little during the recuperation. Low during the season
2	Being able to master the basic techniques early in the season and the performance routines in the pre-competition.
3	Period for potential important technical changes early in the season (Oct., Nov.) then refinement of the gesture (March 2 - April 1)
4	Being able to progressively increase the quantity of arrows while keeping the quality of coordination (automate to perform)
5	Being able to maintain the quality of the coordination and the performance routines despite the stress of the competition situation: i.e. being competitive

**Yearly Plan for Youth for Outdoor and Indoor Target Disciplines**  
*Training distribution shown in percentage of time allocated*

Per fortnight	Oct2	Nov1	Nov2	Dec1	Dec2	Jan1	Jan2	Feb1	Feb2	Mar1	Mar2	Apr1	Apr2	May1	May2	Jun1	Jun2	Jul1	Jul2	Agn1	Agn2	Sep1	Sep2	Oct1	Objectives
General & specific physical preparation	30	30	20	10	10	5	5	5	5	40	10	5	5	5	5	5	5	5	20	20	50	50	80	1A et 1B	
Psychological preparation	10	20	20	20	5						15	5	5	5	5	5	5	5	5	5	5	5	5	2	
Shooting form	50	50	50	30	15	5				10														3	
Automation of the coordination	10		10	30	40	50	50	45	40	10	50	45	35	20	20	20	20	15	15	15	15	0	0	4	
Competition management	0			10	30	40	45	50	55		15	40	55	60	70	70	75	60	60	60	60	0	0	5	
	100	100	100	100	100	100	100	100	100	50	100	100	100	100	100	100	100	100	100	100	100	55	55	90	

**Yearly Plan for Youth for Outdoor and Indoor Target Disciplines**

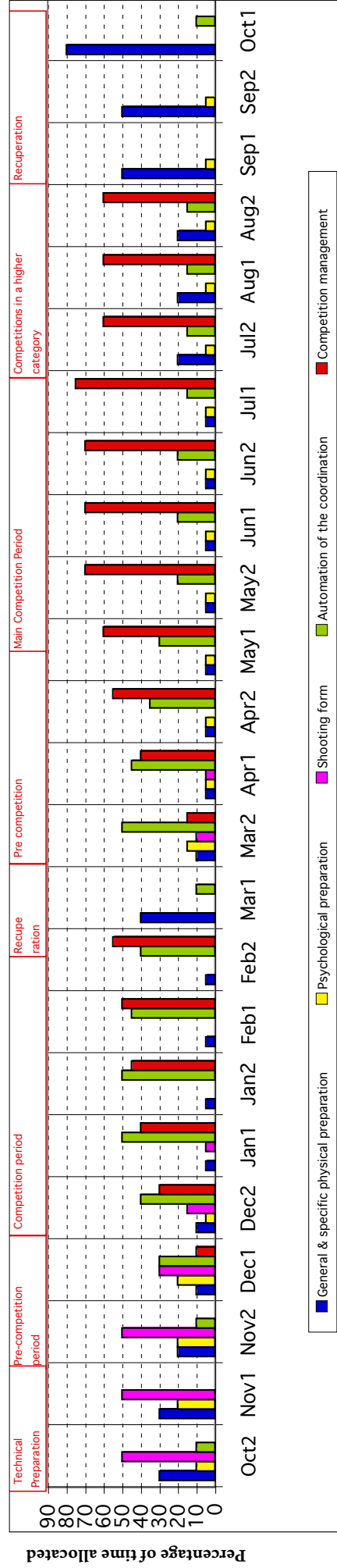

**Objectives**

1A	Important overall physical preparation at the beginning of the season and during the recuperation. Maintain a good fitness during the season.
1B	Important overall physical preparation at the beginning of the season and a little during the recuperation. Low during the season.
2	Being able to master the basic techniques early in the season and the performance routines in the pre-competition.
3	Period for possible technical changes at the start of the season (Oct. Nov.), then small readjustments (March 2, April 1)
4	Being able to progressively increase the quantity of arrows while keeping the quality of coordination (automate to perform)
5	Being able to maintain the quality of the coordination and the performance routines despite the stress of the competition situation: i.e. being competitive



FITA  
Coach's  
Manual

**PHYSIOLOGICAL BASIS**  
**of**  
**ARCHERY**  
Module

Intermediate  
Level





# FITA Coaching Manual

## Intermediate Level

### Module

## PHYSIOLOGICAL BASIS of ARCHERY

### Contents

<b>I. Introduction</b>	2
<b>II. The Cardiovascular System</b>	2
<b>III. Bioenergetics</b>	4
1. The Phosphagen System	5
2. The Lactate System	7
3. The Oxygen System	8
4. Energy Systems and Training	10
<b>IV. The Structure and Function of the Skeletal Muscle</b>	11
<b>V. Literatur</b>	16

### I. Introduction

A range of inter-related factors play a role in an archer's shooting. One of these factors is referred as the physiological determinants of the movements performed in archery. Physiological demands of an event depends on three basic elements of the sport performed at a given time; namely:

- Physio-mechanical movement patterns involved,
- Specific muscle activity performed,
- Intensity, frequency, volume, and duration involved in competition or training.

It is important for the coach to understand the physiological demands of the event or the training; in terms of work time, intensity, the time and duration of rest intervals, in order to define the conditioning elements for a particular archer, and archery itself.

This unit will explain and help to the coach the basic physiological elements that require in constructing relevant training, both for the archer and for the event.

Archery is described as a static sport requiring general and specific strength and endurance of whole and upper body. Shooting an arrow includes some specific movement patterns. These patterns occur in the same sequence

all the time in spite of fatigue. Although archery does not appear to be very fitness demanding, when closely examined, both training and competition do demand a certain extent of long hours of concentration with some ability of strength, endurance, and postural fine control. During a national or an international competition, archer is forced to shoot over 75 shots in a day, where a female archer is to apply approximately 15-16 kg and male 18-20 kg of force each time the bow is pulled. This totals up to at least 1125-1200 kg for females and 1350-1500 kg of force applied in a single day competition in an intermittent manner against an opponent under very stressful circumstances. It, therefore, is a very demanding event on certain musculature and abilities to perform well under every possible environmental conditions when performed for indoors or outdoors, providing that everything is equal.

Thus, it is important for the coach to understand the physiological basis of muscle contraction and strength development, for shooting and postural form; endurance for repetitive shooting and long lasting training and competition. Energy development both for aerobic and anaerobic work, therefore, is important to explain strength and endurance abilities.

To understand the basic content of endurance for archery; the coach has to know the cardiovascular system, aerobic energy development, and the energy sources that are required for such activity during training and/or competition. To be able to apply pulling force to the string and pushing force to the bow, in a specific postural form, which complies with a sound technique, the coach has to understand how the actin and myosin filaments act under action potential to contract and develop muscle activity. This short but relatively intensive type of expression of strength, also, requires some energy for the muscle to contract. It is, therefore, important for the coach to understand the energetic of the movements that govern archery.

### II. The Cardiovascular System

The cardiovascular system comprises of the heart, lungs, and blood vessels. Physiological responses of the cardiovascular system are of primary importance in determining performance during prolonged physical work. Integration of cardiovascular function is coordinated by the cardiac center, which is situated in medulla of the brain stem. This center is responsible for heart rate, stroke volume and blood distribution through out the body via nervous stimulation and hormonal involvement. Cardiovascular function is very much under the control of

psychological stress and as well as by increased physical activity level.

During short, intermittent, or continuous work blood is an essential tissue to bring the oxygen, hormones, nutrients, take excess heat, and other elements that are necessary for work. In a normal individual there is approximately 5-6 liters of blood in males and 4-5 liters in females, and it is not enough to fill all the blood vessels at the same time. Therefore, there is a ration of blood distribution which is regulated by the vessels themselves and by the nervous system. According to the working state of the organs, the blood is directed by vasodilatation (enlargement of blood vessels) or vasoconstriction (narrowing of blood vessels) according to the priority of the working of the organs and muscles during work or rest, which is called shunting of the blood. Figure 1 shows the normal blood distribution in some of the essential organs. Components of the cardiovascular system, therefore, are very important, especially during long lasting work.

There is some basic terminology that a coach should know in understanding basic concept that leads up to the application of terms. They are:

**Heart Rate (HR):** Heart rate is the amount of beats the heart performs under rest or work in one minute.

**Stroke Volume (SV):** Stroke volume is the amount of blood pumped out of heart in each stroke or contraction.

**Cardiac Output (CO):** Cardiac output refers to the volume of blood pumped by each ventricle of

the heart per minute. In a normal individual CO is approximately  $5 \text{ l.min}^{-1}$  (liter per minute) at rest and may increase to  $40 \text{ l.min}^{-1}$  during intensive exercise.

Thus,  $\text{CO} = \text{HR} \times \text{SV}$

Cardiac output is determined by heart rate and stroke volume

Together, the heart and blood vessels provide not only life itself but the physiological basis of all activity, and the ability to work and sustain the activity for some duration (Figure 1). Under almost all different working states there is a fluctuation in HR to help maintain effective blood pressure within the circulation system. Increase in HR together with increase in SV, enhance CO, and thus provide the working muscle with essential supplies of oxygen and substrate to fuel muscular contraction.

Similar to other muscles, the heart will, also, respond to regular exercise. Training increase the heart's ability to contract forcefully which improves the cardiovascular system's capability to distribute blood via an improved capillary network. These adaptations contribute to the performer's ability to undertake continuous steady exercise. This becomes very important in many sports to last for the duration of training or competition. In archery, for example, it is important to have the long lasting training or competition performed without any sign of fatigue or loss of quality in archer's shots.

As a result of effective training on cardiac function is a larger CO, enhanced SV, and a lower HR for a given intensity of exercise or work. Reduced stress on cardiovascular system as a whole and on HR will increase the stability and aiming steadiness during shooting, because a lower HR increases the probability to release the arrow between two heartbeats; beside increasing the working capacity of an archer.

Maximal HR of an athlete, and at what ratio of maximal HR the training of a given biomotor ability, and the training conducted (intensity) are important. Although the athletes differ in maximal HR, and training reduces the achieved maximal HR values, for the average population, the maximal HR is calculated by below equation:

$$\text{Maximal HR} = 220 - \text{Age}$$

It has been observed that for each year of aging there is a tendency of one beat reduction in Maximal HR. However, it should not be forgotten that, those who are involved with top level of coaching and aware of the intensity of

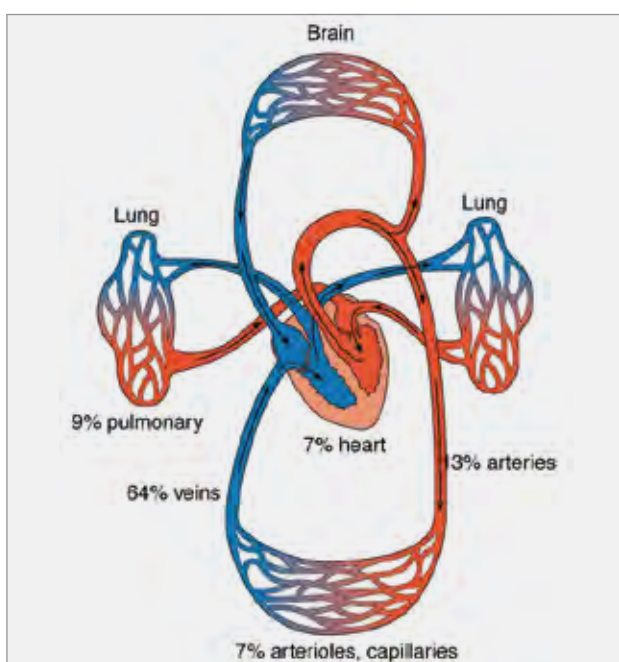

Figure 1: Distribution of blood in the body

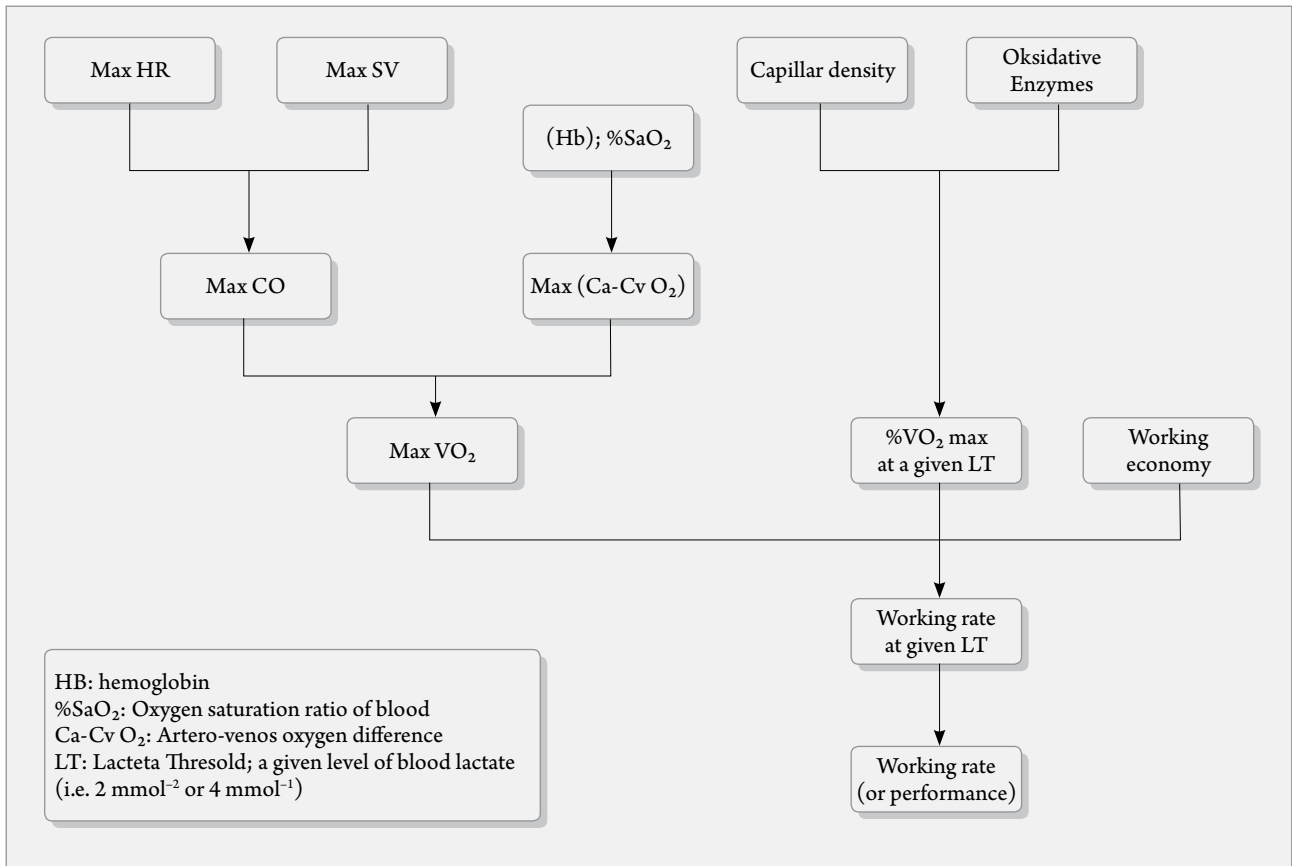

Figure 2: Factors influencing endurance working capacity

training, care should be taken for individual variation in HR for appropriate intensity of training.

Components of cardiovascular function are very important in aerobic capacity and power. Figure 2 gives some idea of how the cardiovascular system affects the performance or training outcome of endurance ability.

### III. Bioenergetics

Living organism needs energy to continue the living form, and to work. Depending on the intensity, duration, amount of muscles employed, and the form of muscles used in work, the required amount and the type of en-

ergy is different. Depending on the rate of energy requirement, there are three basic systems to supply energy for the working muscles. The intensity and the duration of the exercise determines which energy system is going to be used (Figure 3).

The aim of the energy systems is to resynthesize the energy rich phosphagen called adenosine triphosphate (ATP). This is the only biochemical compound that provides the necessary energy for muscle to contract by splitting into inorganic phosphate (P) and adenosine di-phosphate (ADP). Once the ATP initiated the contraction by providing the energy, the three energy systems provide energy to resynthesize ATP for following splits to provide new energy source for muscle contraction and work. Depending on the intensity and duration of muscle work, the rate of energy production is dictated and the energy system is determined. Thus, any exercise requires an energy supply, and there are different energy-supplying systems that their energy supplying power and capacity depends on the intensity and duration of work. As a coach, therefore, to be able to draw up an optimal training schedule the energy supply system has to be well understood.

Intensity and duration elements of the exercise are the determining factor for the energy system employed.

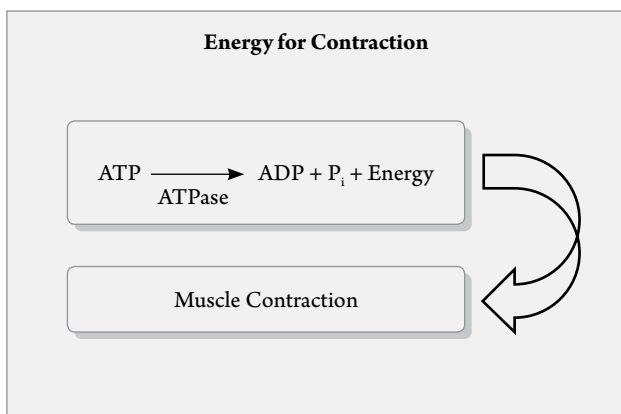

Figure 3: Energy for muscle contraction

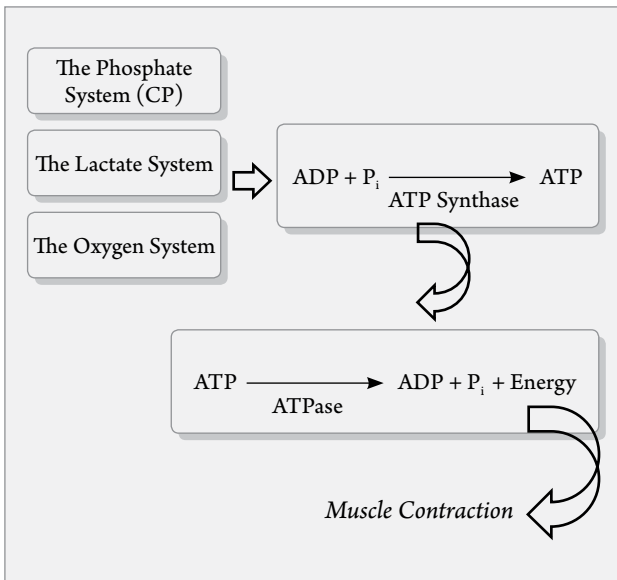

Figure 4: Energy for muscle contraction by different energy systems

When considering the competitive and training character of archery, with shots interspersed with various forms of active or passive forms of rest, understanding the nature of energy production is more important. Three forms of energy systems are named as (1) phosphagen system, sometimes it is also referred as alactic anaerobic energy system or phosphocreatine or ATP-CP system, (2) lactate or glycolysis system, it is also called lactic anaerobic energy system, and (3) the oxygen system, which is also called as aerobic energy system. (Figure 4) shows the simultaneous contribution of the three energy systems during intensive work.

Power and capacity of each energy system is different. Each energy system has its advantage and disadvantages. For example, the phosphagen system provides very immediate energy for very high and rapid movements. Such as short sprints and/or short acts of strength, such as applying strength to the string when drawing the bow. However, although it provides very rapid energy, lasting from few seconds up to 8 or 10 seconds at maximal or sub-maximal efforts, it is very short lasting. On the other hand, the

Table 1: Power and Capacity of Three Energy Systems

System	max power (kcal.dk-1)	max capacity (Total kcal)
ATP-CP	36	11.1
Anaerobic Glycolysis	16	15.0
Aerobic (Only glycogen)	10	2000

lactate energy system lasts for longer duration for rapid works, such as long sprinting, rowing, or repetitive movements lasting for 30 to 45 seconds at maximal or sub-maximal intensities. This energy system is longer lasting, but the energy production over a unit of time (power) is less than compared to the phosphagen system. Despite the fact that this type of work is limited in archery, it is important that some exercises are done within the scope of this energy system to withstand the fatiguing load of some specific movements. The oxygen system, also called the aerobic system, is the longest lasting but the least rapid energy provider among the three systems. It, therefore, has the highest capacity in terms of amount of energy produced for ATP resynthesis, but has the lowest power in terms of providing rapid energy (Table 1).

### 1. The Phosphagen System

The phosphagen system supplies energy without any need of oxygen and production of lactic acid. The muscle has a limited store of ATP, together with another source of energy similar to ATP called creatine phosphate (CP). Limited ATP stored in the muscle is backed up by CP for the resynthesis of ATP for rapid work. The store of CP is, also, very limited but is able to provide very rapid energy for the resynthesis of ATP (Figure 5, Figure 6).

Limited store of ATP and CP in the muscles forces this energy system to function up to 8 to 10 seconds. ATP stores last about 2 seconds and the amount of CP contribute for another 6 to 8 seconds during rapid and maximal work. Under all circumstances the supply of energy for muscle contraction and work has to be through ATP breakdown. ATP breakdown is backed up by CP, and this

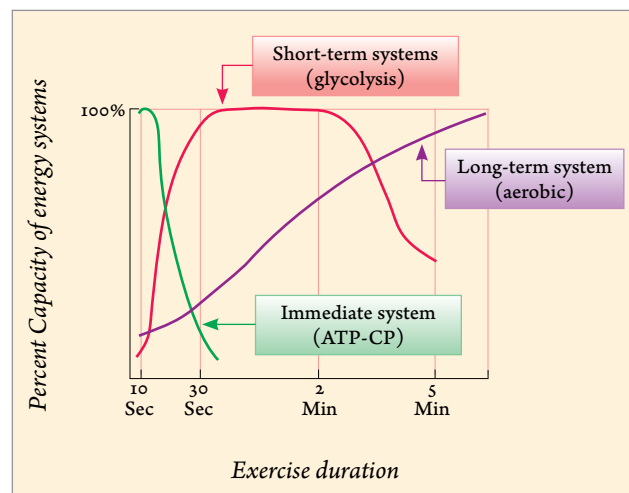

Figure 5: Energy production and relative contribution of energy by different energy systems



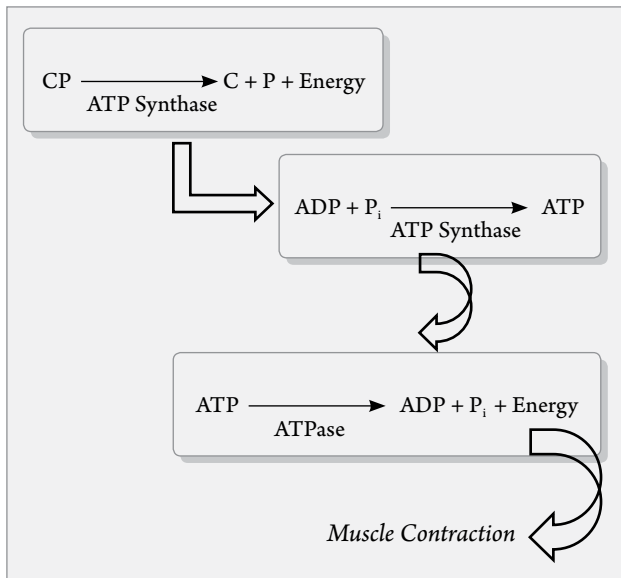

Figure 6: The Phosphate System (CP)

synthesis and breakdowns take place at the onset of any activity. This system is, therefore, very important to initiate any activity, whether it is low or high intensity, and at the high intensity movements such as sprinting, jumping,

rapid pulling, pushing, applying different kinds of force or power applications.

After the breakdown and exhaustion of the CP in the muscle stores, the resynthesis process is also very rapid. The resynthesis of high-energy phosphates (ATP + CP) after work is replenished within few minutes. Approximately 70% of the phosphagens are replenished in 30 seconds and 100% in 3 to 5 minutes (Figure 7).

Thus, training of the phosphagen system has to be short, explosive, and limited in number of repetitions, and alternated with long rest intervals for the replenishment of phosphagens. The replenishment or recovery of the phosphagens are met by the oxygen system, through the synthesis of glycogen, free fatty acids, or under special conditions, by the breakdown of proteins

Not only short, rapid, and powerful work but also endurance type of training, not less than three times per week and lasting 6 to 7 months, has positive effect in increasing muscle ATP and CP stores up to 50%. This increase in muscle stores help the athlete to have better capacity for activities lasting up to 10 seconds. Sprint

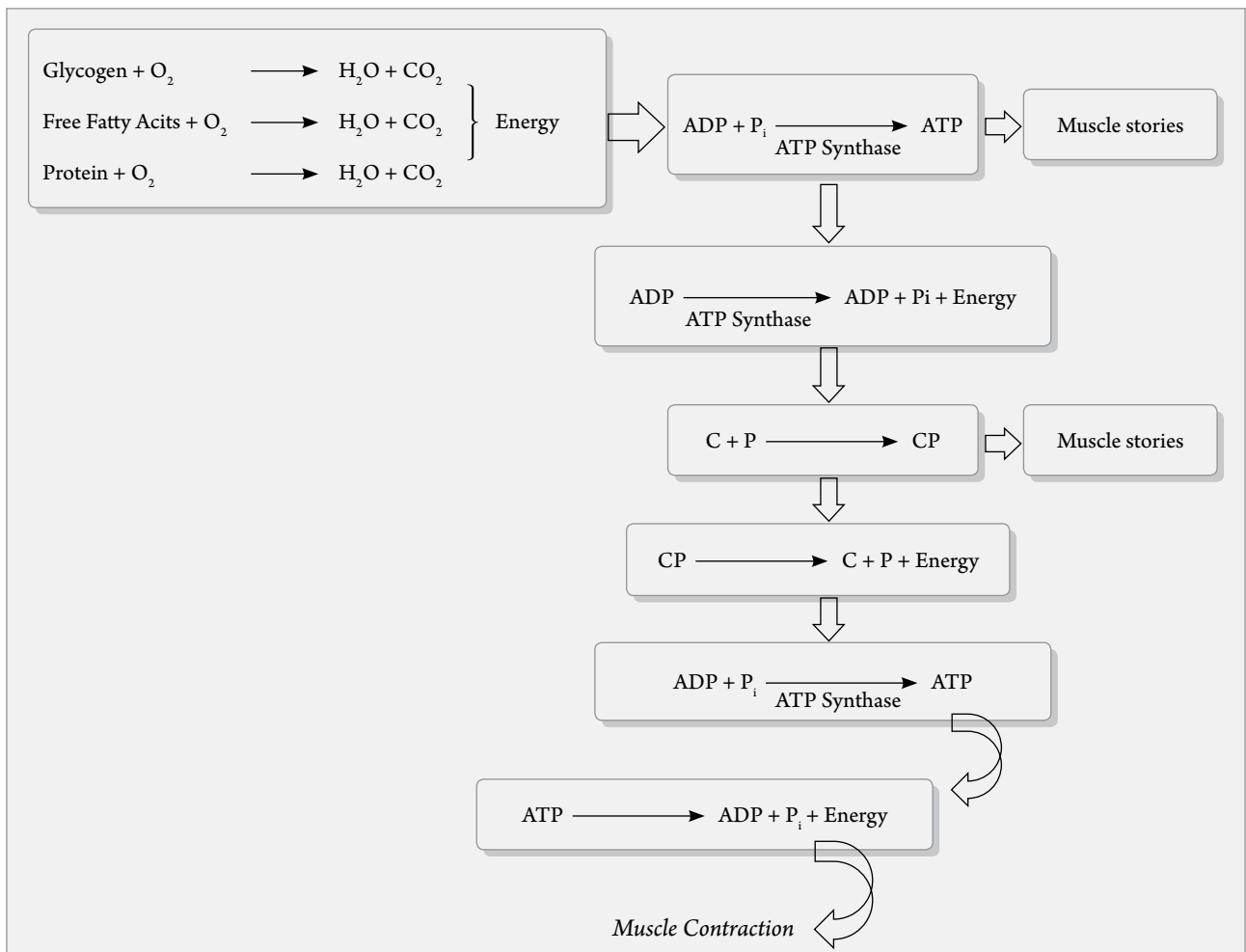

Figure 7: The recovery of muscle phosphagens during rest

type of short, powerful, and rapid trainings increase the ability of muscles to rapidly breakdown the phosphagens for rapid release of energy, and rapid resynthesis of the phosphagens by increasing the enzymes that are responsible for these processes. Both type of trainings, therefore, not only increase ATP and CP stores but also speeds up the process of rebuilding ATP and CP. Increased ATP and CP adaptations and enhanced enzyme activity can only be brought about by well designed endurance, strength and power trainings for the archer. These training adaptations will enable the archer to shoot similar shots more repetitively, have higher capacity for training, and develop less fatigue at the end of the training session.

## 2. The Lactate System

Normally, the human body prefers to use the oxygen system to produce energy for all functions of the body, including muscular work. However, if the level of muscular exertion increases and it passes the point at which the aerobic energy system is unable to produce enough energy to keep up with the work demand, the anaerobic or the lactate energy system begins to produce and contribute energy for the work. The contribution or amount of energy produced depends on the intensity and duration of the exercise, and the ability of the aerobic energy system to produce energy under such intensity of exercise. The lactate energy system, therefore, is an additional energy system to contribute both to the phosphagen system, in case of a high intensity of exercise lasting more than 8 to 10 seconds, and/or to produce additional energy to meet the demands of the work, in the case of the aerobic energy system, where it is unable to produce such amount of energy at a required rate. However, due to slow reaction of the

aerobic energy system to the pace and demands of exercise, similar to the phosphagen energy system, the lactate energy system as well contribute to the energy demands of the work right from the onset of exercise whether it is low or high intensity. Involvement of the lactate energy system in energy production under such conditions shows itself by the by product of lactic acid as a result of break down of glycogen in the absence of oxygen in the cell (Figure 8). Increase of lactate at cellular level during anaerobic work, changes the acidity of the cell, which is an indication of muscular fatigue. After a certain level of acidity, depending on the individual and training level, the chemical reactions slow down drastically, and force the athlete to slow or even to stop working. This condition is called acidosis. Muscle soreness is a typical characteristic of acidosis. In some sports such as middle distance running, rowing, cycling where the lactate energy system is used predominantly the athletes are often faced with acidosis. Increase of blood lactate levels is an indication of anaerobic supply of energy, and deficiency of aerobic energy system for a given level of intensity of work. Increase of blood lactate can be 20 times higher than resting levels, reaching well above 20 mmol/l level in some cases.

As explained above, high levels of lactate accumulation cause acidosis in and around the muscle cells which in return alters the reactions and mechanisms in the cell. One of the mechanisms seriously disturbed by this change in the cell is the aerobic enzyme activity by which the aerobic energy production is unable to function. As a result of this, the endurance capacity of the muscle cell is reduced. If this type of work is repeated without sufficient rest in between the workouts, the aerobic energy system, and therefore, the endurance capacity of the athlete is hampered for some period or overtraining state may develop.

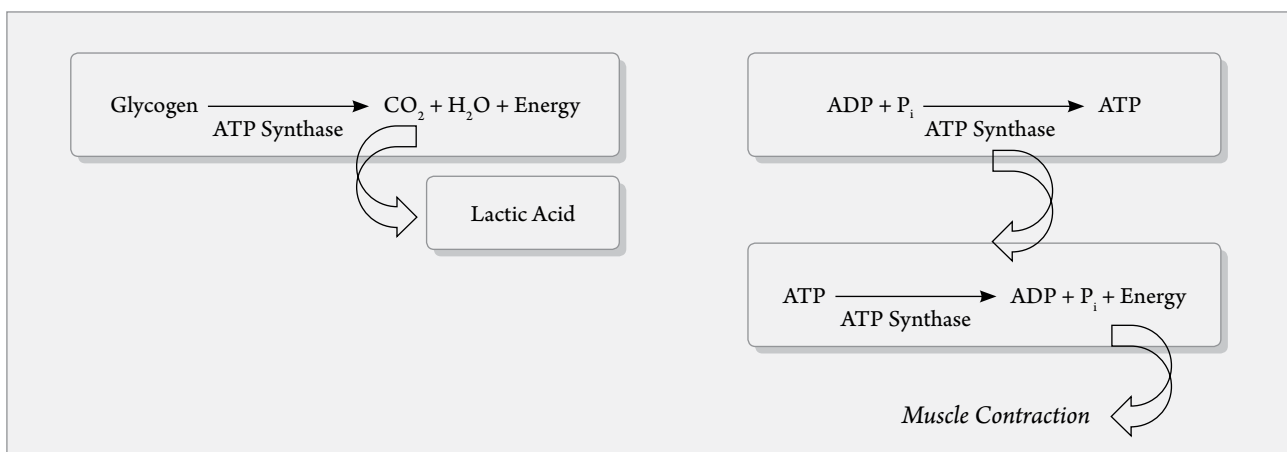

Figure 8: The Lactate Energy System

In the presence of high levels of lactic acid in the cell the formation of the CP is also delayed, which in return reduces the ability of sprinting or high level of expression of strength with fine skill and control of movement. Therefore, under such conditions work of archery technique or skill is not recommended.

The acidosis state does not only slow down the reactions and mechanisms of the muscle cells, but also damages the cell walls leading to leakages from the muscle cell into the blood. This state causes changes in the blood, and after heavy workouts as an indication of fatigue and muscle cell damage there are high readings of blood values of urea, creatine kinase, aspartate aminotransferase, and alanine aminotransferase. Normalization of this state may take up to 1 to 4 or 5 days after the completion of the training. After a heavy workout the body eliminates half of the lactate in approximately 15 to 25 minutes in a passive rest state. Approximately 90-95% of the accumulated lactate is removed after about an hour. After a heavy workout the accumulated lactate is removed at a much faster rate if there is a light exercise state for rest or recovery instead of complete rest.

The lactate energy system uses only muscle glycogen for energy production for ATP resynthesis. At high lactate state in the muscle cell, glycogen cannot be used and this state in return decreases the use of fats as energy substrates. Without the use of glycogen, fats cannot be metabolised in the cells as energy source.

Typical lactate workout may start from short distances such as 100 to 800 meter runs or 20 seconds up to 3 to 4 minutes of very intensive workouts. The workouts in the range of 20 to 45 seconds are more dominantly rely on the lactate energy system and less on aerobic energy production. When the time is increased towards 3 to 5 minutes of heavy work, the contribution of aerobic energy supply is increased to almost 50 %. Except for very specific workouts, the use of lactate dominant training content in archery is very limited.

Thus, technique training is not recommended when the blood lactate levels are exceeding 6 to 8 mmol/l levels. High lactate values, therefore, increase the risk of muscle injury. It is, therefore, recommended that the caution for recovery training is taken after lactate predominant trainings.

### 3. The Oxygen System

The oxygen system, also, refers as aerobic energy system, is the physiological foundation of the endurance performance. Archery is one of the exceptional events that

Table 2: Maximal Oxygen Consumption in Different Sports

Sport	Max Oxygen Consumption (ml.kg <sup>-1</sup> .dk <sup>-1</sup> )	
	Male	Female
Marathon Running	75-80	65-70
Cross-Country Skiing	75-78	65-70
Soccer	55-60	48-52
Tennis	48-52	40-45
Gymnastic	45-50	40-45
Rythmic Gymnastic	-----	40-45
Sailing	50-55	45-50
Archery	39-51	34-42
Shooting	40-45	35-40

rely on aerobic energy system, and it is regarded as an endurance event. However, the archer does not show a typical aerobic capacity and power of a marathon runner or cross-country skier, or even a soccer player (Table 2). Yet the endurance ability that is described for the archer is very critical in the success of an archer, and, therefore, the foundation of endurance ability has to be well understood by the coach.

The oxygen or aerobic energy system is an ability of processing the nutrients in the presence of oxygen. In other words, the ability of the energy system to produce energy from carbohydrates, fats and proteins in the presence of oxygen during rest and activity. Compare to other two energy systems, the oxygen system is relatively non-time-related way of producing energy for work. Under normal conditions body utilises carbohydrates and fats as main energy source, and under starvation and prolonged exercise conditions rely on proteins. In terms of energy, depot fat is almost unlimited source of energy, provided that through training the metabolism adapts to the utilisation of fats. Carbohydrates are consumed as sugars, starches, and glucose and stored in the liver and muscles as glycogen, and easily utilised by the body as a source of energy. The store of glycogen in the liver and muscles is relatively limited, and under intensive aerobic work, the sources are to provide approximately 2000 kcal or enough to last 60 to 90 minutes. It is interesting to also note that the lactic acid that is produced during anaerobic work, also, utilised as substrate, similar to glycogen, by the aerobic energy system in muscles, liver, and the heart muscle. This is the basic mechanism to eliminate the lactic acid from the working muscles and circulating blood (Figure 9).

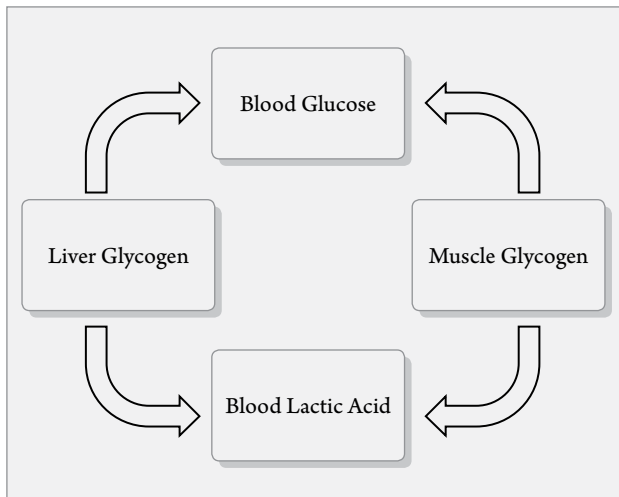

Figure 9: Elimination of lactic acid (The Cori cycle).

The oxygen or aerobic energy system is the most economical energy system compare to other two systems. Body usually prefers to use aerobic energy system. From the economy point of view, the tendency of the body is to use fats as source of energy since this source of substrate provides the highest amount of energy for the resynthesis of ATP per molecule of substrate. However, when the intensity of work becomes very critical, such as running faster or working harder to win, the organism prefers the fuel of which provides higher energy source for per litre of oxygen. In this case, glycogen is a better source of energy to yield higher amount of energy in the resynthesis of ATP (Figure 10). Therefore, during low intensity of work, the mechanism has the tendency of using free fatty acids in greater percentage compare to glycogen, as the availability of oxygen is not critical. As the rate or intensity of work is increased, the ratio of utilisation shifts towards glycogen as a result of critical amount of oxygen availability for energy development. Increase in aerobic fitness increases the usage of fats in the organism. Thus, in endurance trained athletes, for a given intensity of work, the utilisation of fats as energy source is increased. Therefore, the athletes are able to work at much higher paces due to carbohydrate sparing effect of training. The glycogen as a source of energy called at much higher work loads due to increased fat utilisation of the body. Maximal oxygen consumption or  $VO_2$  max is an indicator of a developed endurance ability of an athlete. The capacity to utilise the greater percentage of  $VO_2$  max at a given value is a good indicator of endurance performance. Max  $VO_2$  values can be increased up to 50 percent by training.

Under all conditions, the organism prefers to use the oxygen system since it is more economical and has more

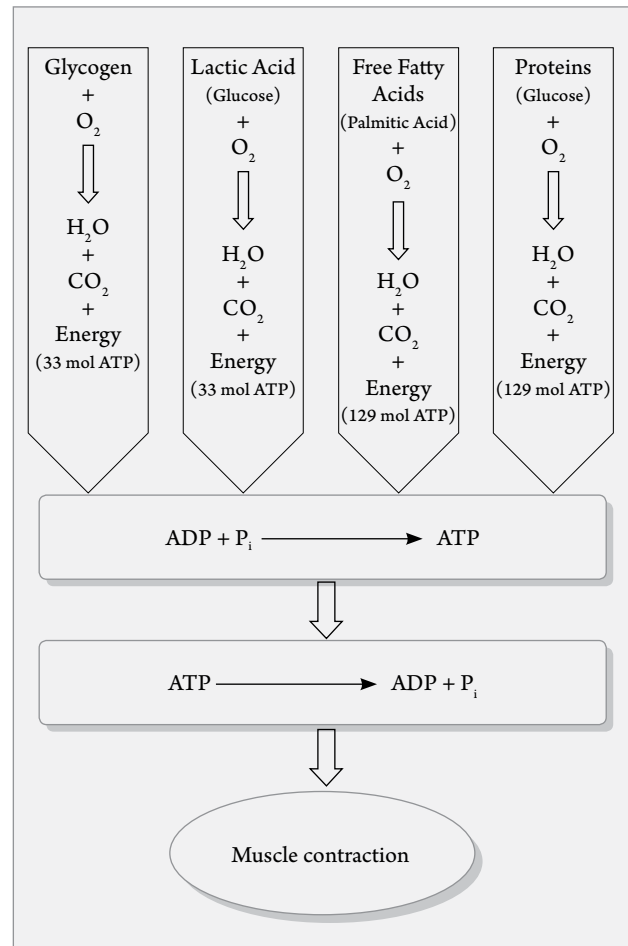

Figure 10: The oxygen or aerobic energy system and ATP resynthesis by the breakdown of substrates.

capacity for the production of energy for ATP resynthesis. However, as mentioned in the phosphagen and the lactate systems, the oxygen system has a limitation in its power to provide energy in a unit of time. If the required amount of energy for a given time and intensity exceeds the power of aerobic system (Table 1), then the anaerobic energy systems provide the extra needed energy for muscular work. Furthermore, aerobic system functions with the provision of oxygen in the cell, within the mitochondrias where the aerobic breakdown of substrates take place (Figure 10).

For increased rate of work, the aerobic energy system needs extra amount of oxygen to meet the elevated level of energy for the ATP resynthesis. However, depending on the elevated level and the intensity of the work, the extra amount of oxygen has to be provided by increased level of HR (Heart Rate), circulation and transport of oxygen within the cell. These mechanisms are unable to meet the pace of the work immediately, and they have a lack of pace. Due to this delay, the aerobic energy production is unable to meet the required energy demands, and



elevated extra energy requirement is met by the anaerobic mechanisms. Usually it takes about 2 to 3 minutes for the aerobic mechanism to adapt the pace of the work in training or competition. Therefore, as the work time increases, the oxygen system becomes more dominant in producing energy for the resynthesis of ATP and work (Table 3).

#### 4. Energy Systems and Training

It is some times very difficult for the coach to understand the simultaneous contribution of energy production of energy systems when explained as above. One gets the feeling that each and every energy system functions separately, depending on the intensity and duration of work. This is not true. In fact all energy systems function at the same time simultaneously. However, depending on the intensity and duration of the exercise, and of course, the training level of the athlete, each energy system has a ratio of contribution at a given time and state. It is therefore, very important to understand the intensity and duration elements of the workload, since they are the determining factors in which energy systems work. When the energy systems are adapted for practical training concept, different training areas or zones can be identified (Table 4). Each training zone, therefore, depending on the intensity and duration, has many training methods of which have similar characteristics of physiological adaptations. In other words, each intensity and duration characteristics training elicit different physiological adaptation (Table 4). It is, therefore, very important for the coach to recognize the training zones and their characteristics in eliciting physiological adaptations, which are important for the sport in question. In this case, archery is an endurance based event, where the archer is involved with repeated shots, which are alactic anaerobic. With long lasting ac-

Table 3: *Physiological adaptations at different intensity levels*

Level	% VO <sub>2</sub> max	HR max %	Physiological Adaptation
I	55-65	60-70	aerobic energy sources (+) aerobic energy pathways (+) capillar density (+) number of mitochondria (+) mobilization of fats (+)
II	66-75	71-75	aerobic energy sources (+) aerobic energy pathways (+)
	76-80	76-80	aerobic energy pathways (+) participation of FOG fibers (+) aerobic glycolysis (+) oxygen transport system (+)
III	81-90	81-90	anaerobic energy pathways
IV	91-100	91-100	neuromuscular (+) koordination, speed Lactic/phosphagen system
V	100-140	100	neuromuscular coordination, speed, (+) Strength (+) phosphagen system (+)

tivity, active or passive, during the day, inter spread with shots, the aerobic system is taxed. This taxation is not exhaustive (Figure 11), but yet, very critical that meets the required demands, without any slightest loss of ability due to fatigue after some shots in the progress of competition or training.

Most archers pay extra attention to the bow, strings and arrows, and they try to keep technologically up to date and sound equipment. However, in most cases similar attention is not paid to the fitness level, especially the general and specific endurance components, which are very important prerequisites for success. An archer should develop general and specific endurance in using aerobic and

Table 4: *Different Training Zones based on intensity and duration of work*

Intensity Zones	Training	Repetition times	Work/rest ratio	Lactate Content (mM)	HR (bpm)	Intensity (Max %)
5	Trainings for Phosphagens Systems	4-15 Sec	1:4 1:25	—	Sub-max Max	95-100
4	Lactate Tolerance Trainings	1. 30-60 sec 2. 2-2.5 min	1:2 1:3	12-18 (20)	Sub-max max	95-100
3	VO2 Max trainings	3-5 min	2:1	6-12	180	85-90
2	Anaerobaic Threshold trainings	1. 1.5-7 min 2. 8-60 min	1:1 1:2	4-6	150-170	85-90
1	Aerobic Threshold trainings	10-120 min	1:1 1:0.2	2-3	130-150	60+

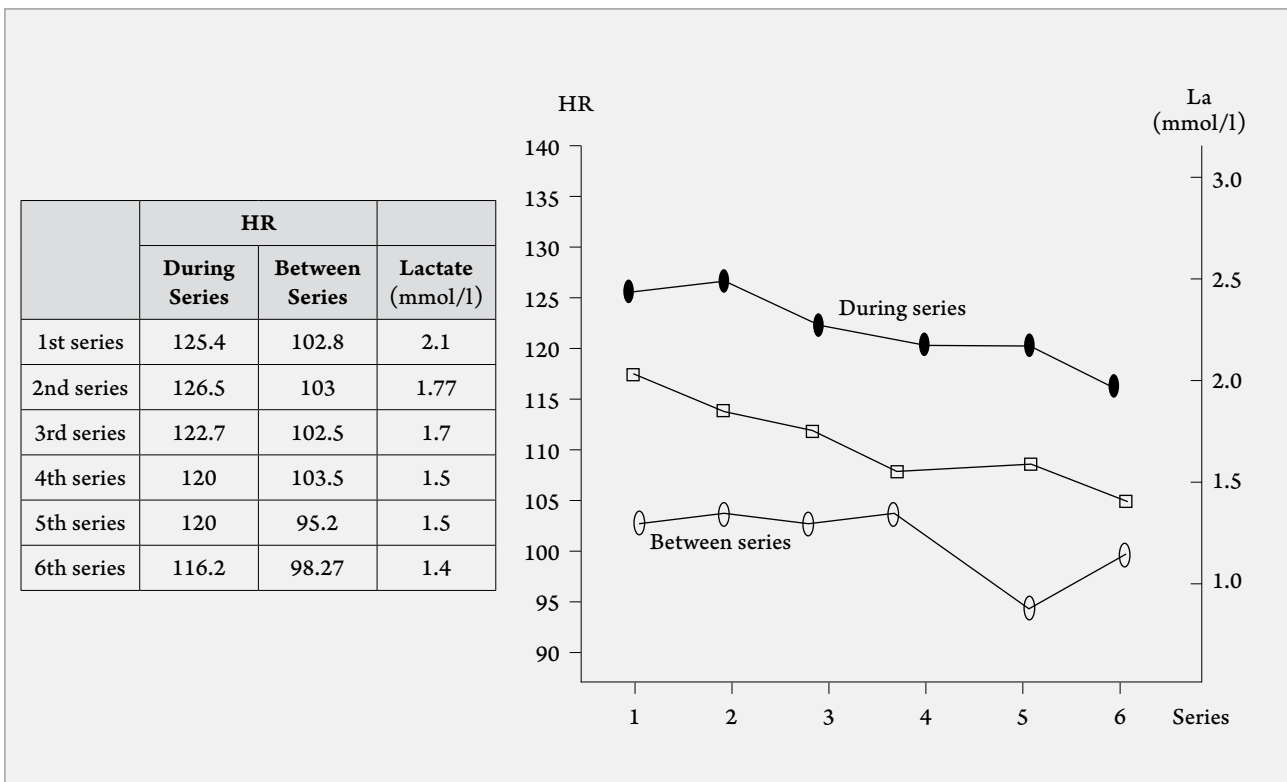

Figure 11: HR mean values and lactate values of 6 top level female archers during and in between series

anaerobic threshold training areas. For strength and coordination, training for phosphagens intensity zone should be employed for specific fitness (Table 4).

**IV. Structure and Function of the Skeletal Muscle**

Skeletal muscle is the main source of the movement mechanism, where the generation of strength is formed for the movement. And, thus, without the skeletal muscle, movement cannot take place. The human body contains over 400 skeletal muscles with different sizes and shapes. And as the human body is shaped through growth and development, the final formation is also formed (Table 5). From these figures it is apparent that almost 40 to 50% of the body weight is constituted out of muscles. Skeletal muscle has four main functions in the body: (1) to generate force for locomotion, (2) force generation for posture, (3) force generation for breathing, and (4) heat produc-

tion under cold stress. As coaches, this short section will deal with the force generating ability of the skeletal muscle.

Most noticeable function of the skeletal muscles is to enable to move, to have a postural form, and to help to breathe. In order for the skeletal muscle to generate force, it has to be attached to a bone or bones. From one end it has to have an attachment of origin, in order to move the other end of the attachment (insertion) for locomotion or pull the string or push the bow. The muscles are attached to the bones by tough and resilient connective tissue called tendons. To keep muscle intact there are three layers of connective tissue: Epimysium, covers the whole muscle, the outer layer. If it is moved one step down in the muscle, perimysium is the layer which surrounds the muscle bundle. Each muscle fiber or the cell within the muscle bundle is surrounded by the inner layer endomysium. These layers end up forming the tendons for the connection to the bones at each end, where the force is applied to the bones as muscle contract (Figure 12).

Table 5: Muscle development during growth and development

Age	% of body weight
4-6	20
7-10	23
10-12/13	25-28
12/13-14/15	30-35
16/19	33-45
19/22	45-50

The smallest unit of the muscle that contracts is called myofibrils. These are the contractile protein structures, and are composed of two proteins called actin and myosin. The myosin proteins are the thicker proteins structures with some arms extending, which are called cross-bridges by which they connect to special sites of

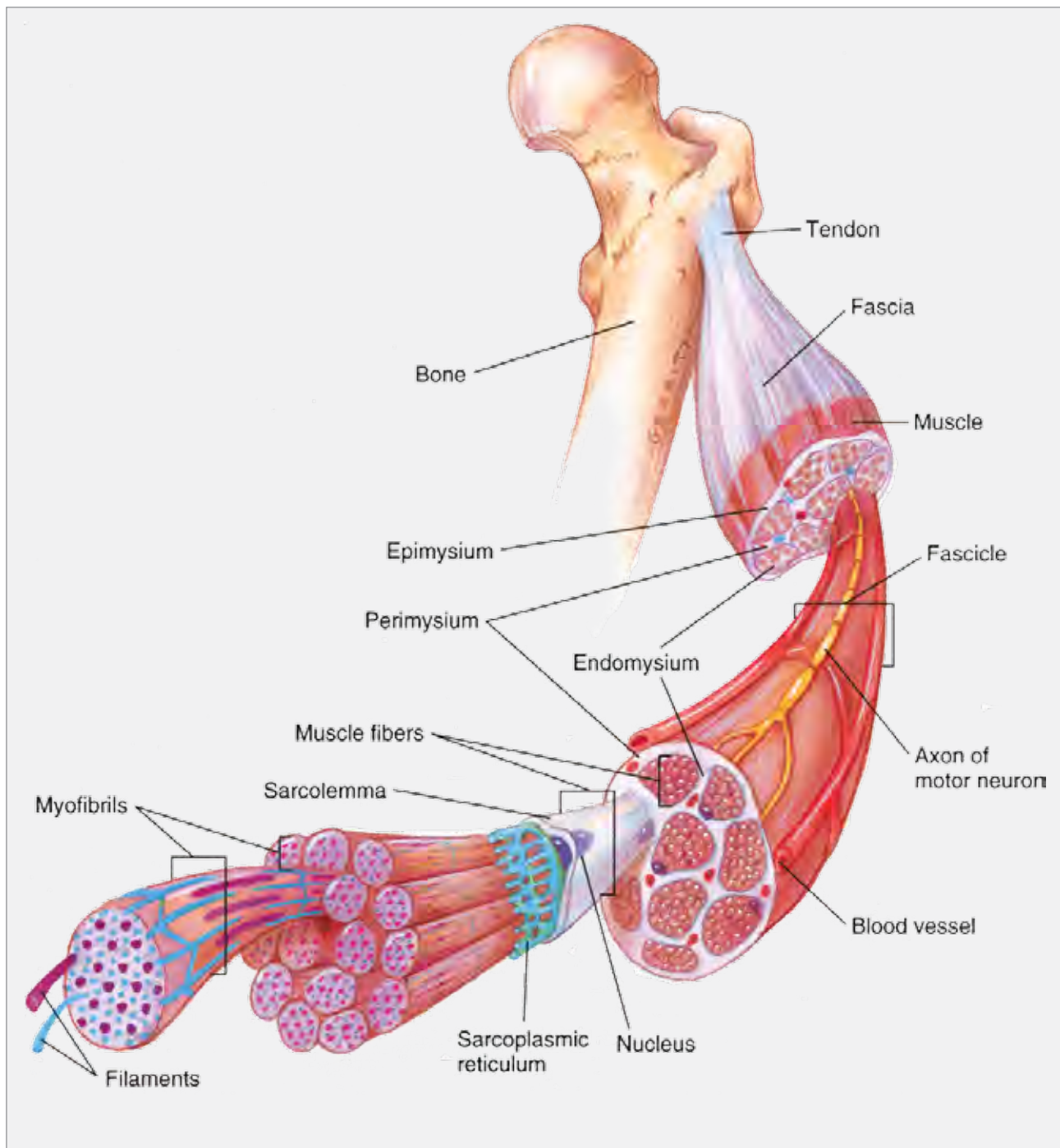

Figure 12: Showing various components of a muscle

actin filaments for contraction, when there is a contraction stimulus (Figure 13). Contraction simply occurs by the shortening of the muscle myofibrils where actin slides over myosin. The sliding action brings together the Z lines at both ends of the muscle unit at this level called sarcomere. This basic action is the simplest form of very complex muscle contraction, and is named sliding filament model.

Muscle develops strength by this simplified form of contraction. However, muscle does not shorten its length always to apply force. In archery, to keep up the desired

posture and balance during shooting, most of the muscles are contracting without changing their length.

There are three identified muscle actions and force generations, namely isometric, isokinetic, and isotonic. For isokinetic muscle action, the velocity of movement during the application of strength throughout the range of movement is constant. This type of muscle action is artificially generated, and there is no such action in the application of archery. For strength development purposes, special workouts can be employed. Isometric where the length of the muscle does not change, yet there

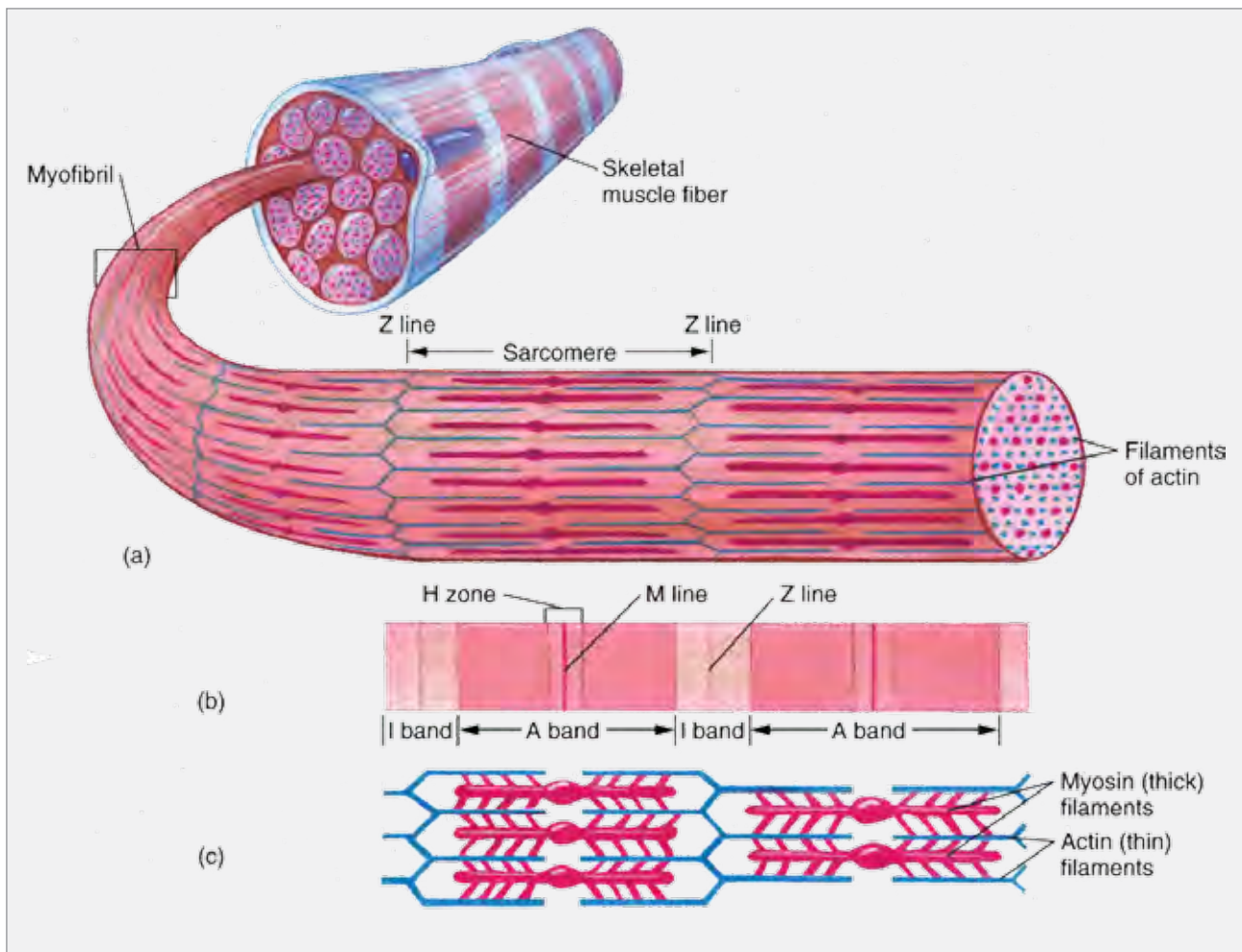

Figure 13: Construction and contraction of actin and myosin filaments

is an application of force, it is a frequently used form of movement in archery. Isotonic action and application of force is frequently used in archery. This action can be performed concentrically, where the length of the muscle is shortening while applying force, or eccentrically, where lengthens as the force is applied. Since several forms of muscle action is taking place in archery, in general and specific strength development this aspect of the event should be taken in consideration. the range of movement is constant. This type of muscle action is artificially generated, and there is no such action in the application of archery. For strength development purposes, special workouts can be employed. Isometric where the length of the muscle does not change, yet there is an application of force, it is a frequently used form of movement in archery. Isotonic action and application of force is frequently used in archery. This action can be performed concentrically, where the length of the muscle is shortening while applying force, or eccentrically, where lengthens as the force is applied. Since all forms of muscle action is taking place in

archery, in general and specific strength development this aspect of the event should be taken in to consideration.

Muscle contraction is stimulated by a motor neuron which relays the action potential. Motor neuron extends outward from the spinal cord and as it reaches the muscle, and by branching, it innervates many muscle fibers. The motor neuron and muscle fibers, that are innervated, form the motor unit. When there is an action potential, the whole muscle fibers in the motor unit contract all together, providing that the action potential is at a desired threshold to activate the contraction. In a muscle, there are many number of motor units, and they differ in size according to number of fibers they contain, as well as the type of muscle characteristics they show. In humans, there are three types of skeletal muscle fibers, and every muscle consists of three types of fibers. Each motor unit consists of similar fiber types. The muscle fibers are classified as red or slow or Type I, and white or fast or Type II muscle fibers. Fast muscle fibers are further subdivided in to fast aerobic or Type IIa and fast glycolytic or Type IIx. Type I muscle fibers are also named as slow-twitch, and Type II



Table 6: Characteristics of skeletal muscle fiber types

Characteristic	Slow Fibers	Fast Fibers	
	Type I	Type IIx	Type IIa
Number of Mitochondria	High	Low	High/Moderate
Resistance to fatigue	High	Low	High/Moderate
Predominant energy system	Aerobic	Anaerobic	Combination
ATPase activity	Low	Highest	High
Vmax (Speed of contraction)	Low	Highest	High
Efficiency	High	Moderate	Low
Specific tension	Moderate	High	High

muscle fibers as fast-twitch according to their contracting velocities. The amount of force that a muscle develops depends on the number of motor units and their sizes that are activated. In general, smaller motor units have lower activation thresholds and produce lower tension.

Type I fibers in general form the smaller motor units. They contain rich capillaries and mitochondrias, and, therefore, they show better aerobic ability and resistance to fatigue. Their force production is relatively low, com-

pare to white or Type II fibers. They contract relatively slowly, but work for a long time, therefore, suitable for endurance type of work. Type II fibers or white fibers have the ability to contract relatively more forcefully and with a faster contraction ability. Type IIa muscle fibers are moderately capillaried and richer mitochondrial content, and therefore, better endurance ability, lower contraction velocity and tension abilities compare to Type IIx muscle fibers. However, Type IIa has much higher contraction

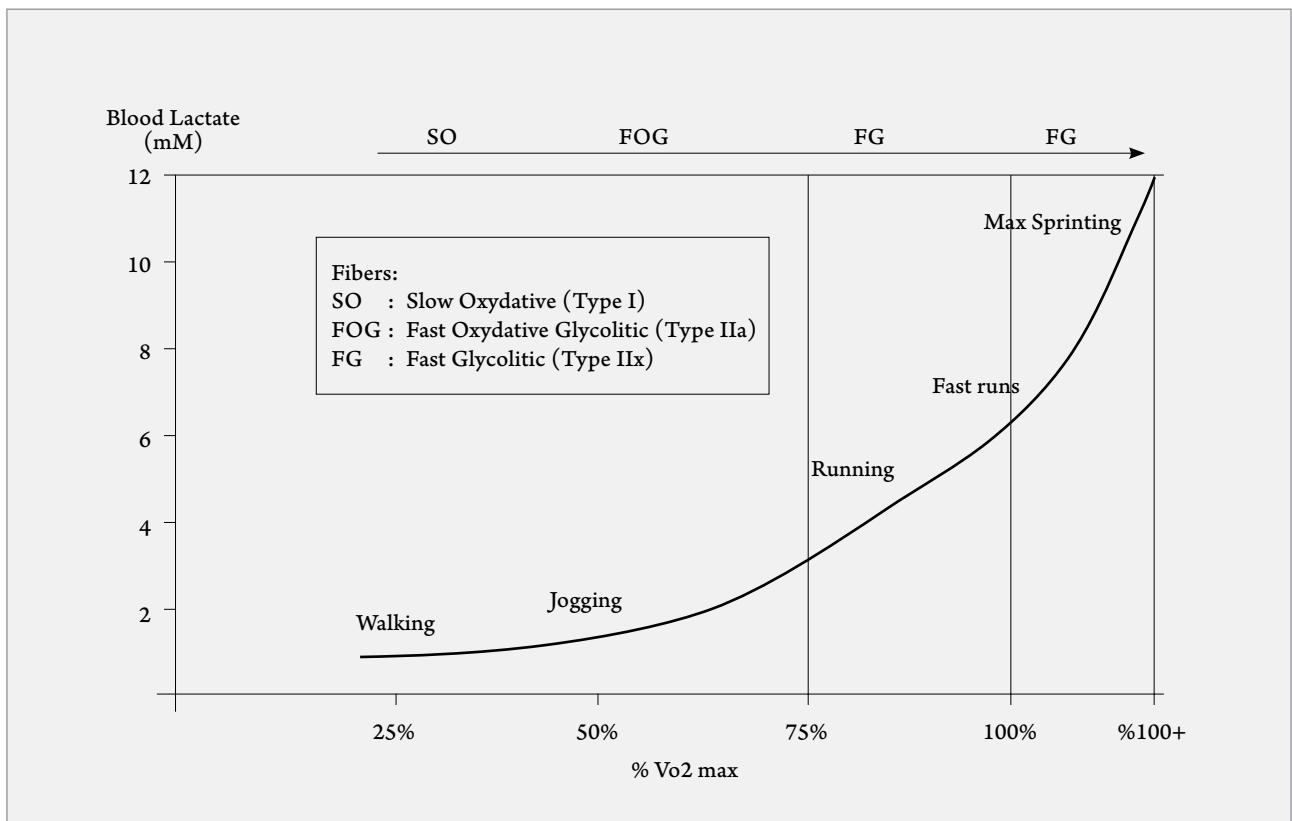

Figure 14: Intensity of Work and Metabolic Responses

velocity and tension abilities compare to Type I muscle fibers. Type IIx has the least endurance ability, and shows higher contraction velocity and muscle tension compare to other two types of fibers (Table 6).

Starting from light to moderate activities, such as walking, easy cycling, jogging to running, the activity can be maintained for many hours. Energy supply is almost fully aerobic, utilising free fatty acids, mainly in the type I muscle fibers. Increase pace or activity level will shift the energy source towards carbohydrates, and well trained endurance athletes can maintain this type of aerobic activity for about 1 to 2 hours, leading almost to the exhaustion of the muscle glycogen reserves of the Type I and Type IIa muscle fibers. More intensive activities such as running or moderate to high sprinting will activate Type IIa and perhaps Type IIx muscle fibers utilising the lactate and as well as the phosphagen energy systems. If the work intensity is elevated to such trainings as maximal sprint training or high intensive intervals, Type IIx muscle fibers are activated. During such activity the energy supply is solely anaerobic, muscle glycogen and phosphagens are the energy sources (Figure 14).

In normal sedentary population the ratio of slow twitch fibres is approximately 47% to 53%. In terms of muscle fiber distribution, there is no difference between the sex and age. However, in certain sports, there is a tendency to show higher percentage of certain muscle fibers. For example while the power athletes, namely the sprinters and throwers show higher percentage of Type II fibers, the endurance athletes show Type I fibers (Table 7).

Table 7: Muscle fiber composition in elite athletes

Sport	% Type I (Slow fibers)	% Types IIa/IIx (Fast fibers)
Distance runners	70-80	20-30
Track sprinters	25-30	70-75
Nonathletes	47-53	47-53

However, it is known that the higher ratio of a particular fiber does not make the individual better athlete in that event, since a very complex interaction of psychological, biochemical, anatomical, neurological, cardiopulmonary, biomechanical, and environmental factors play a role. This is also apparent from the wide range of muscle distribution exhibited by the elite athletes. However, it is exhibited that both the endurance and resistance type strength trainings cause a change of muscle fiber from fast-to-slow in contrary to very recent belief (Figure 15). There is no change in type I fibers towards Type II fibers, but there is a change particularly from Type II to Type I. As for archery, the nature of the event does not demand any particular inclination for the muscle fibers, since there is not any exhaustive activity taking place. Therefore, it is postulated that, the muscle fiber distribution does not enhance or deprive the performance in archery. Decision making, hand eye coordination, postural control, concentration ability, mental resilience, basic and special endurance and strength abilities seem to play greater role in success rather than fiber type inclination.

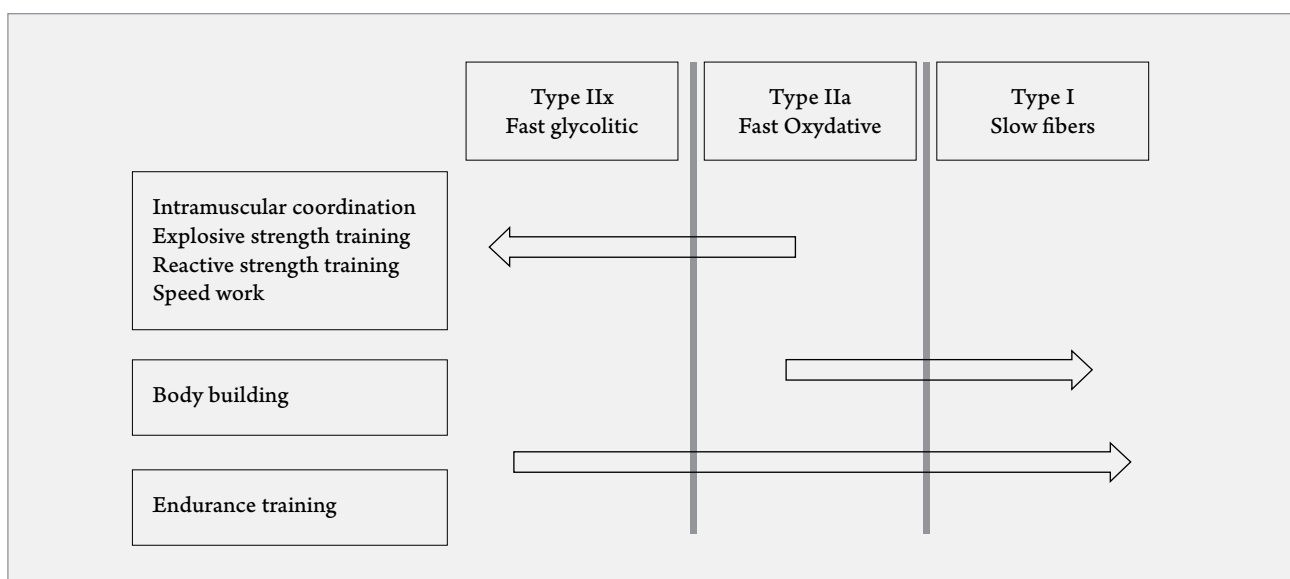
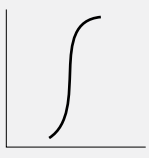
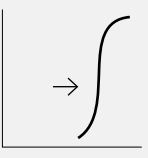
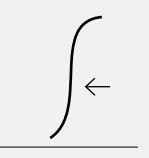
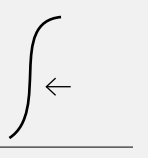
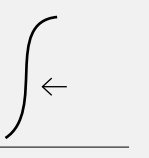

Figure 15: Muscle fiber types and their response to training

Figure 16: Strength-time interaction of strength training process during the training year.

Preparation Period			Competition Period	
Anatomical Preparation	Hypertrophy	Maximal Strength	Transfer Power	Maintenance
 100 250 400ms	 100 250 400ms	 100 250 400ms	 100 250ms	 100 250ms
No change  20-60%	Shifts to right  60-80%	Shifts to left  70-80%	Shifts to left - Deuser or elastic band workouts - 30-50% strength endurance - Using bow with Different tension weights	Remains shifted to left

One of the critical bio-motor abilities in archery is strength. Despite the fact that there is not a high demand of strength in a single draw, but when the total activity during training or competition is considered, the total draws and demand of strength level becomes an important prerequisite. Archery does not demand high maximal strength as in throwing or explosive events. However, it requires certain basic all round strength in order to build specific strength on top of it. In archers there is a general tendency to work on specific muscle groups and develop specific strength without forming a suitable general strength foundation. It is, therefore, recommended to first develop general strength or form anatomical preparation, including whole body muscle groups, as well as specific muscle groups for drawing the bow and shooting. This work is then followed by maximal strength work for certain muscle groups to form ap-

propriate foundation for specific strength work, which has to be followed (Figure 16).

It should be kept in mind that strength training should be planned according to time available for training and competition, as well as strength development duration necessary for physiological adaptation. Strength does not only develop through muscle hypertrophy, but also, through inter and intra neuromuscular coordination. In fact, strength development due to muscular coordination takes place before the hypertrophic development. Therefore, the training design and the number of general and specific strength exercises should be planned accordingly. Figure 16 shows that strength training should be carried out the whole year round. Strength-time relation has to be taken into account as the strength training progresses. It should be remembered that in order to develop specific strength anatomic preparation is important.

#### IV. Literature and origin of the illustrations

**Powers, Scott K. and Howley Edward T.**, Exercise Physiology: Theory and Application to Fitness and Performance. Fifth Edition. *Mc Graw Hill Higher Education*. 2004. ISBN: 0-07-292181-1

**Açıkada, C., Ertan, H. and Tinazcı, C.** Shooting Dynamics in Archery. In *Sports Medicine and Science in Archery*. Eds E. Ergen and Karol Hibner. *FITA Medical Committee*. 2004, pp.15-36.

**Shepard, R.J.**, Determinants of Endurance Performance. In *Endurance in Sport: Volume II of the Encyclopedia of Sports Medicine an IOC Medical Commission Publication In Collaboration with the International Federation of Sports Medicine*. Eds R.J. Shephard and P.-O. Astrand, Second Edition, *Blackwell Science*. 2000, pp 21-36. ISBN 0-632-05348-8

**Astrand, P.-O.**, Endurance Sports. In *Endurance in Sport: Volume II of the Encyclopedia of Sports Medicine an IOC Medical Commission Publication In Collaboration with the International Federation of Sports Medicine*. Eds R.J. Shephard and P.-O. Astrand, Second Edition, *Blackwell Science*. 2000, pp 9-15. ISBN 0-632-05348-8

**Janssen, P.**, Lactate Threshold Training. *Human Kinetics*. 2001. ISBN: 0-7360-3755-1

**Franklin, B.F.**, Cardiovascular Responses to Exercise and Training. In *Exercise and Sport Science*. Eds William E. Garrett and Donald T. Kirkendall. *Lippincott Williams & Wilkins, A Wolters Kluwer Company*, Philadelphia, Baltimore, New York. 2000, pp 107-116.

**Burke, E.R.**, Heart Rate Monitoring and Training. In *Precision Heart Rate Training for Maximum Fitness and Performance*. de Edmund R. Burke. *Human Kinetics*, 1998, pp. 1-27. ISBN 0-88011-770-2